



US00D665849S

(12) **United States Design Patent**
Bengyak

(10) **Patent No.:** **US D665,849 S**

(45) **Date of Patent:** **** Aug. 21, 2012**

(54) **HAND SIGN**

(76) Inventor: **Christopher Edward Bengyak**, Vero Beach, FL (US)

(**) Term: **14 Years**

(21) Appl. No.: **29/374,153**

(22) Filed: **Jul. 9, 2011**

(51) **LOC (9) Cl.** **20-03**

(52) **U.S. Cl.** **D20/29; D20/33**

(58) **Field of Classification Search** D20/10,
D20/12, 19, 29-33, 40, 99; 40/446, 538,
40/541, 584, 586; D2/615; D21/400
See application file for complete search history.

(56) **References Cited**

U.S. PATENT DOCUMENTS

D429,285 S * 8/2000 Schini D20/32
(Continued)

OTHER PUBLICATIONS

NY—Trademark Registration No. 2790409, Dec. 9, 2003 New York Football Giants, Inc. Corporation New York Trademark Electronic Service System (TESS), at www.uspto.gov.*

(Continued)

Primary Examiner — Mary Ann Calabrese

(57) **CLAIM**

The ornamental design for a hand sign, as shown and described.

DESCRIPTION

FIG. 1 is a right-side elevational view of a first embodiment of a left-hand hand sign according to the invention;

FIG. 2 is a left-side elevational view of the left-hand hand sign of FIG. 1;

FIG. 3 is a reduced scale rear elevational view of the left-hand hand sign of FIG. 1;

FIG. 4 is a reduced scale top plan view of the left-hand hand sign of FIG. 1;

FIG. 5 is a reduced scale bottom plan view of the left-hand hand sign of FIG. 1;

FIG. 6 is a reduced scale front elevational view of the left-hand hand sign of FIG. 1;

FIG. 7 is a perspective view from below the front of the right side of the left-hand hand sign of FIG. 1;

FIG. 8 is a perspective view from above the rear of the right side of the left-hand hand sign of FIG. 1;

FIG. 9 is a left-side elevational view of a second embodiment of a right-hand hand sign according to the invention;

FIG. 10 is a right-side elevational view of the right-hand hand sign of FIG. 9;

FIG. 11 is a reduced scale front elevational view of the right-hand hand sign of FIG. 9;

FIG. 12 is a reduced scale top plan view of the right-hand hand sign of FIG. 9;

FIG. 13 is a reduced scale bottom plan view of the right-hand hand sign of FIG. 9;

FIG. 14 is a reduced scale rear elevational view of the right-hand hand sign of FIG. 9;

FIG. 15 is a reduced scale perspective view from below the rear of the left side of the right-hand hand sign of FIG. 9; and,

FIG. 16 is a reduced scale perspective view from above the front of the left side of the right-hand hand sign of FIG. 9.

The “NY” logo is a registered trademark registered/owned by: (Registrant) New York Football Giants, Inc. Corporation New York 50 State Route 120 Timex Performance Center East Rutherford New Jersey 07073.

1 Claim, 10 Drawing Sheets

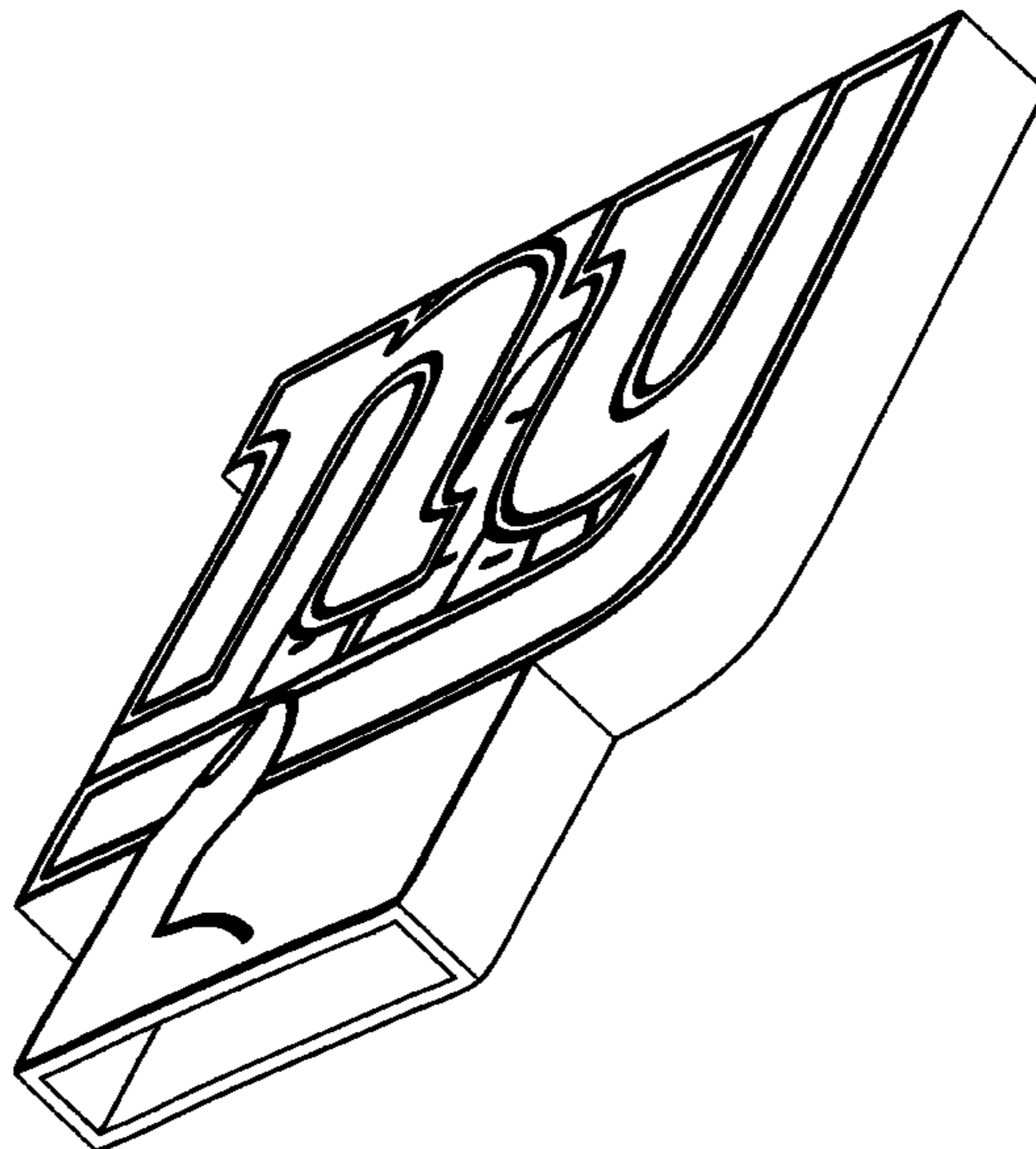

US D665,849 S

Page 2

U.S. PATENT DOCUMENTS

D628,650 S * 12/2010 Lake D20/33
D628,651 S * 12/2010 Lake D20/33
D633,152 S * 2/2011 Scott D20/33
D633,945 S * 3/2011 Scott D20/33
D633,946 S * 3/2011 Scott D20/33
D641,424 S * 7/2011 Bengyak D20/29
D641,791 S * 7/2011 Scott D20/33
D647,571 S * 10/2011 Bengyak D20/33

D649,598 S * 11/2011 Bengyak D20/33
D651,652 S * 1/2012 Bengyak D20/29

OTHER PUBLICATIONS

New York Giants Logo (2000 -)—Chris Creamer's sportslogos.net
<http://www.sportslogos.net/logo.php?id=91> pulled from the web on
Jan. 9, 2012.*

* cited by examiner

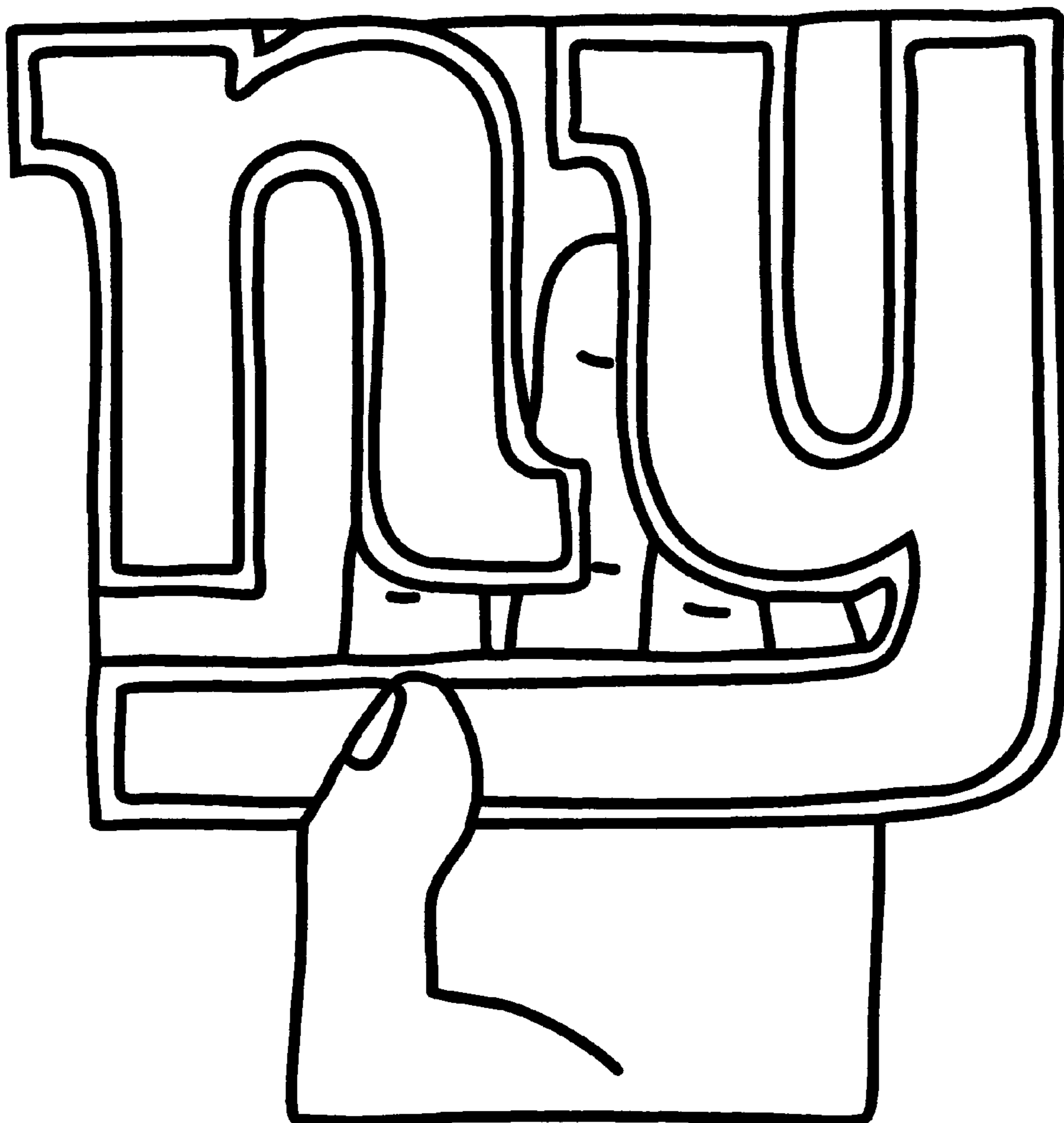

FIG. 1

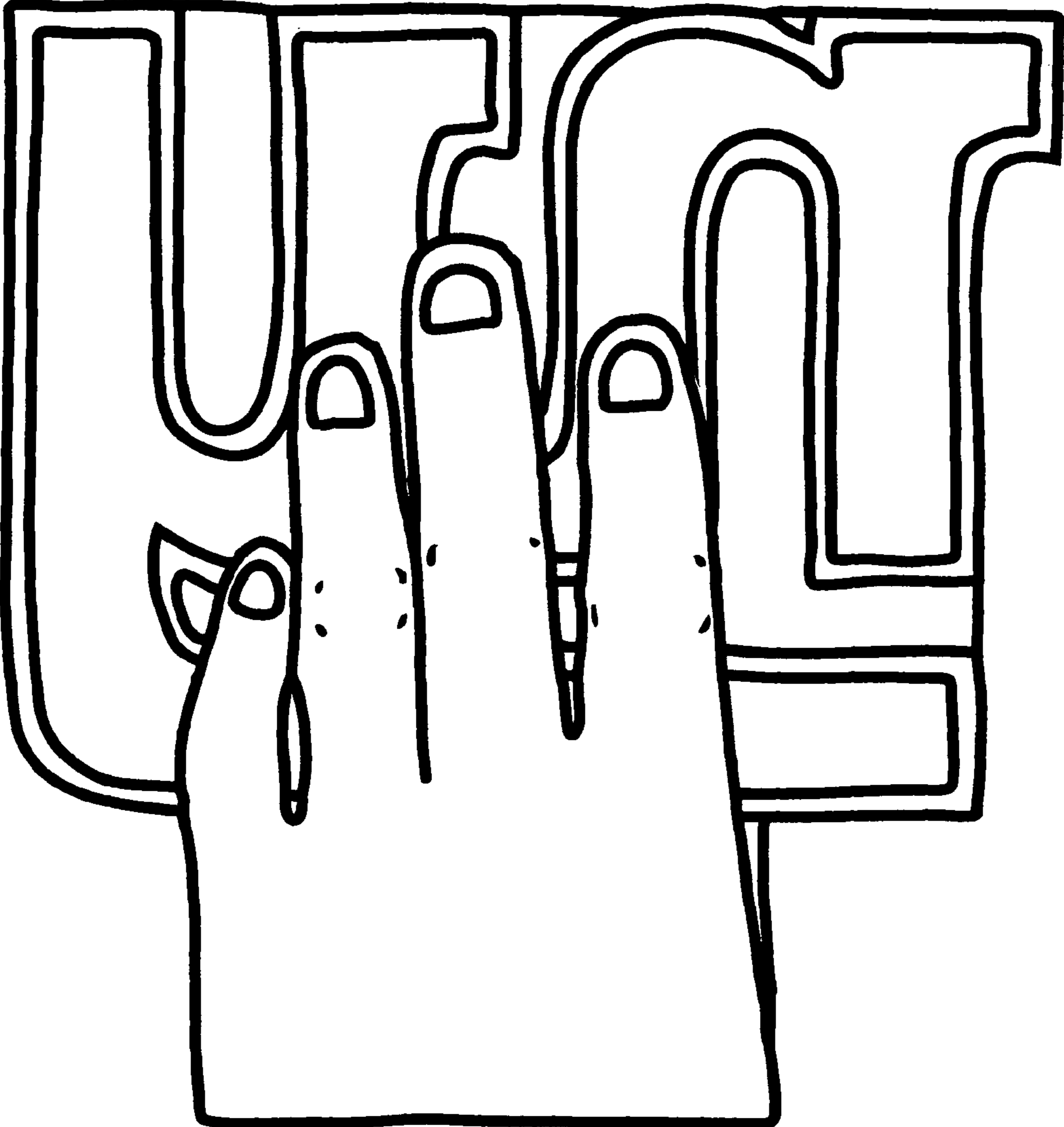

FIG. 2

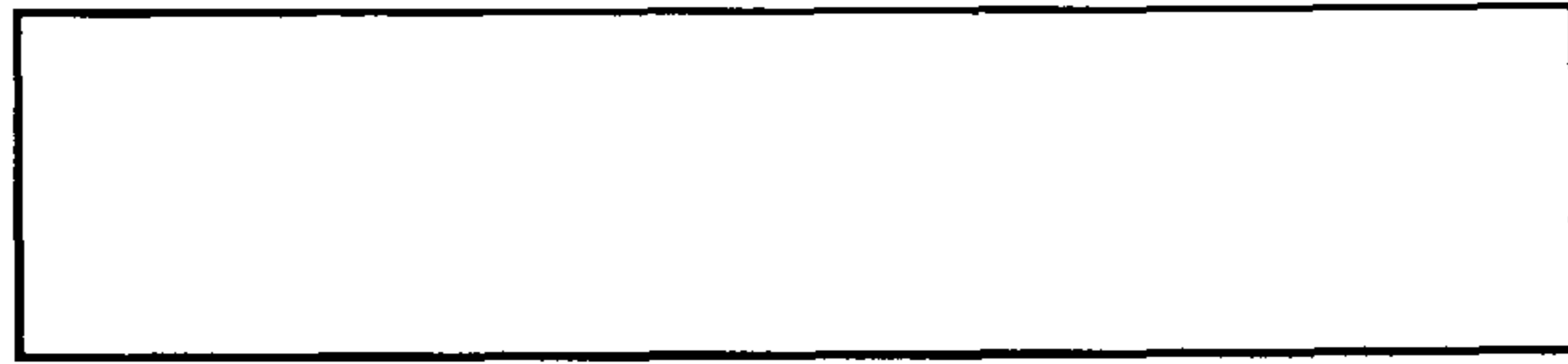

FIG. 4

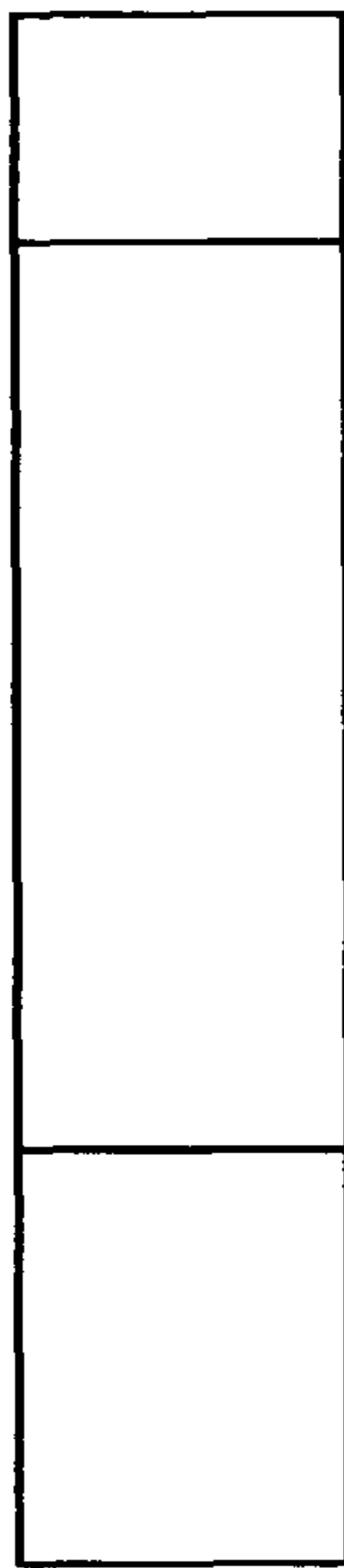

FIG. 3

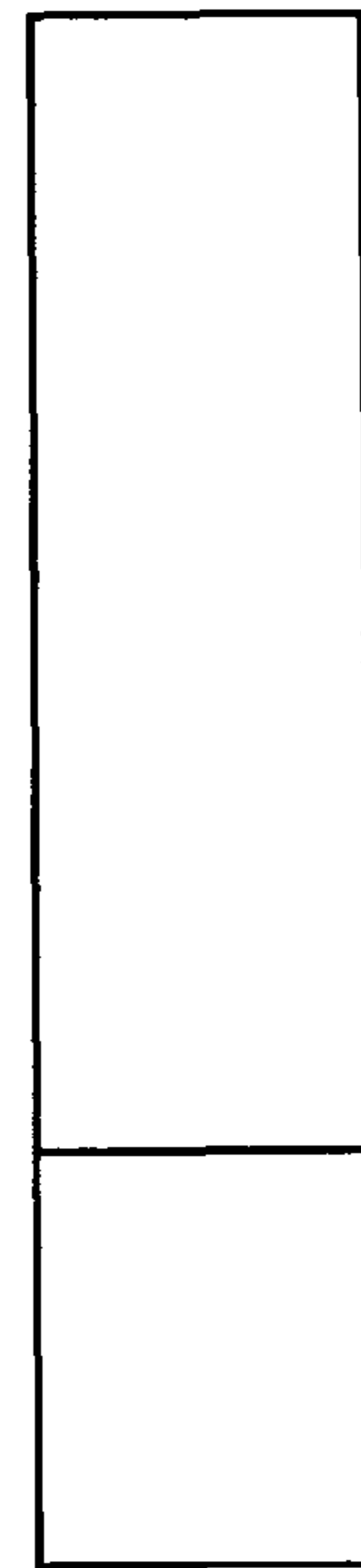

FIG. 6

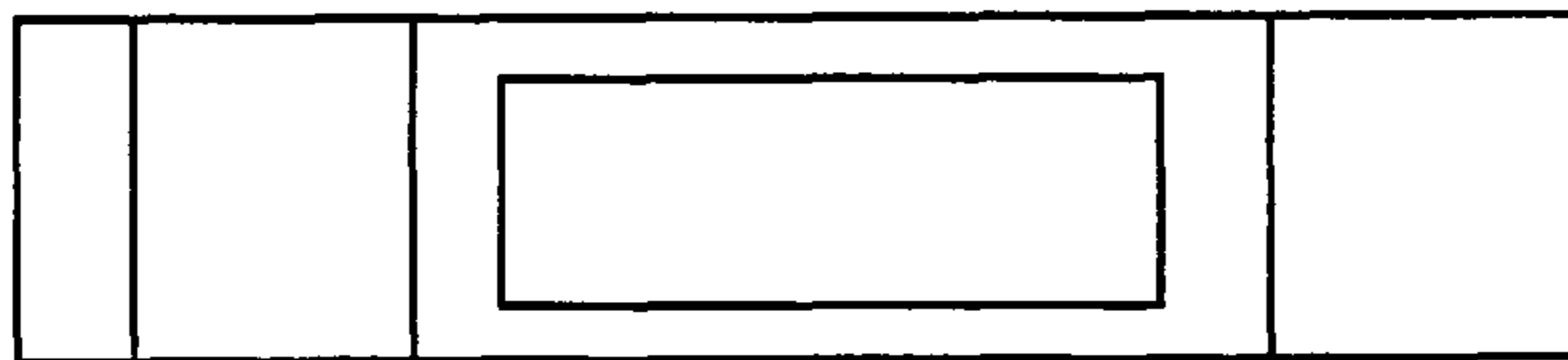

FIG. 5

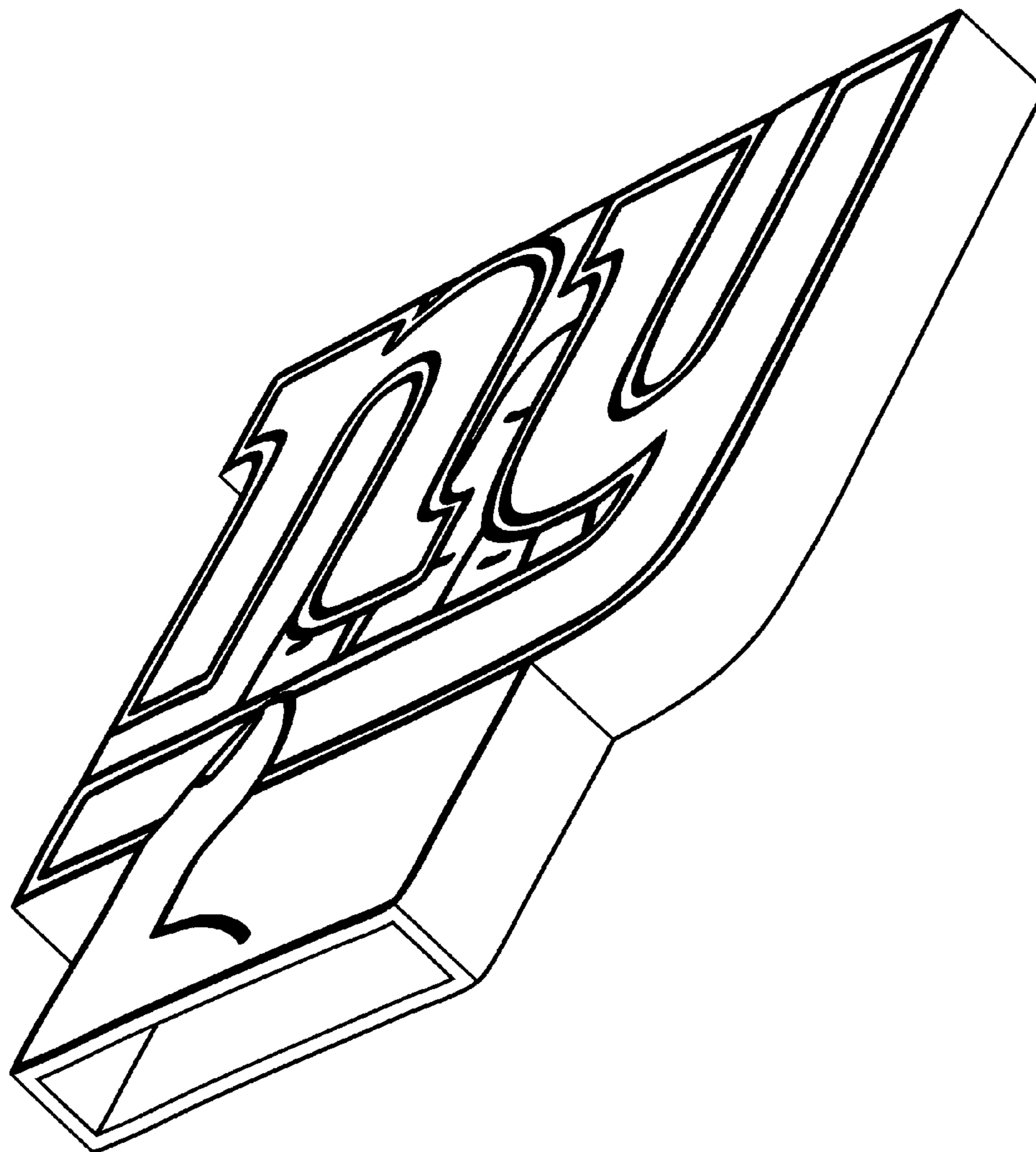

FIG. 7

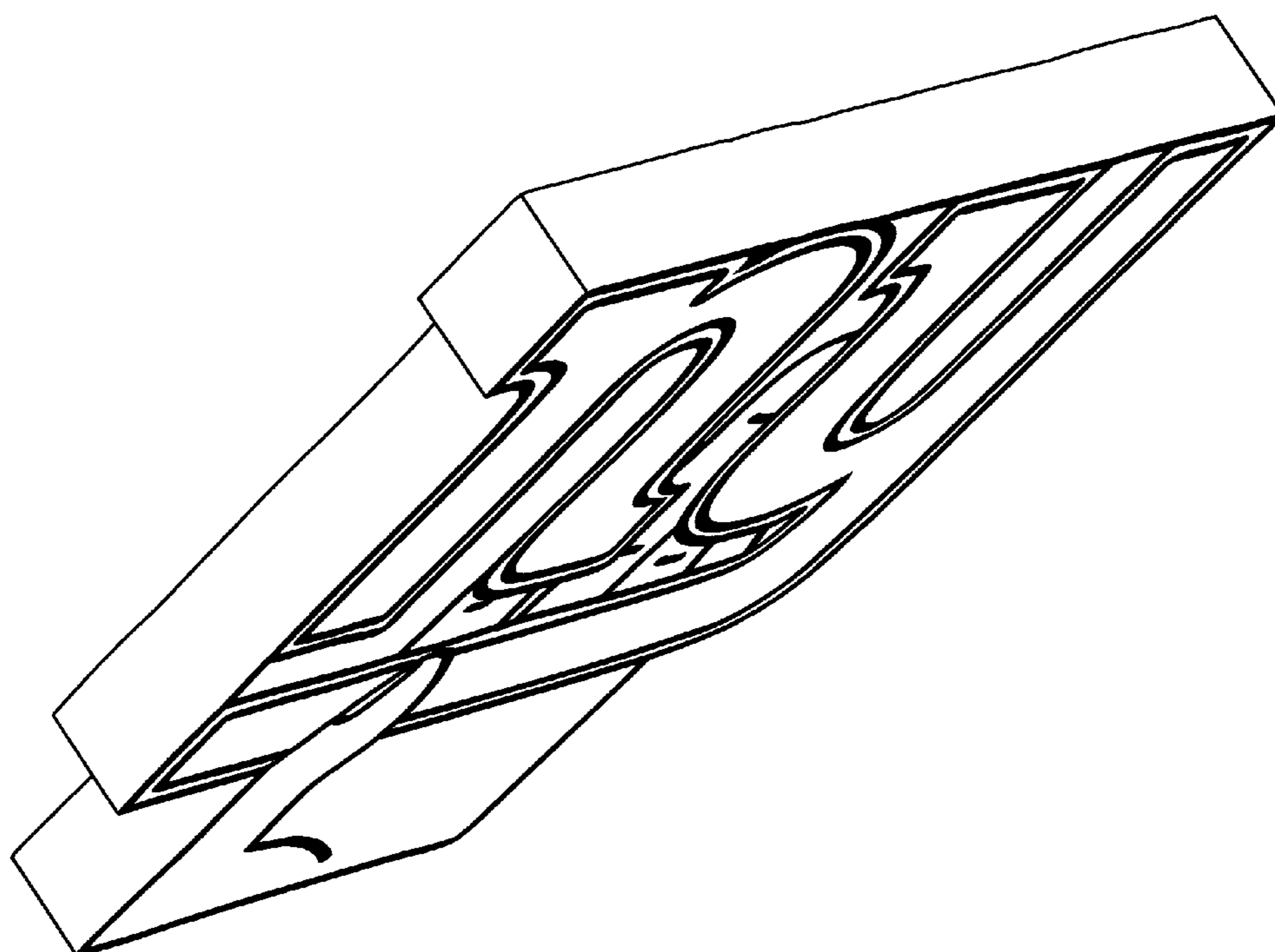

FIG. 8

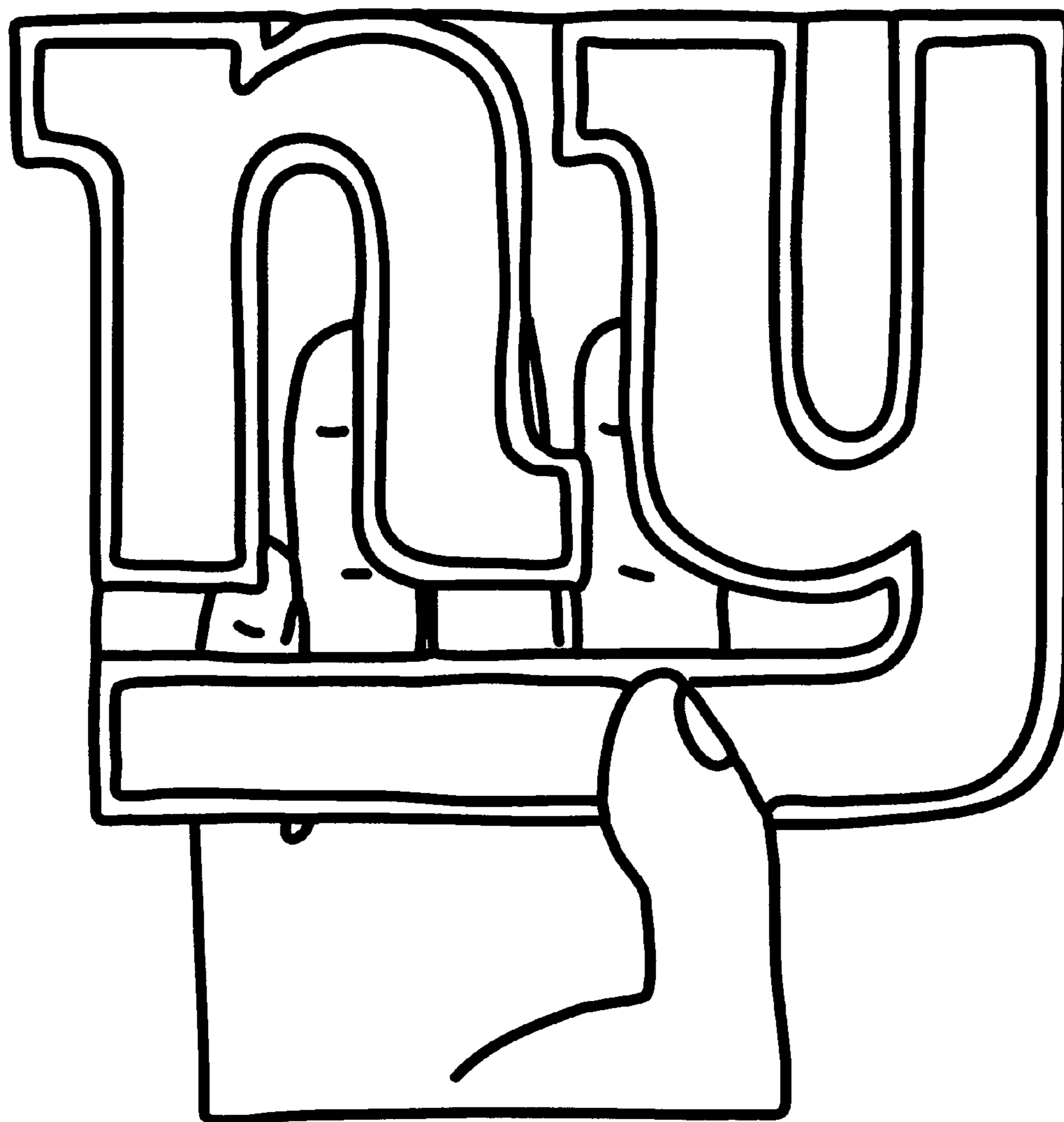

FIG. 9

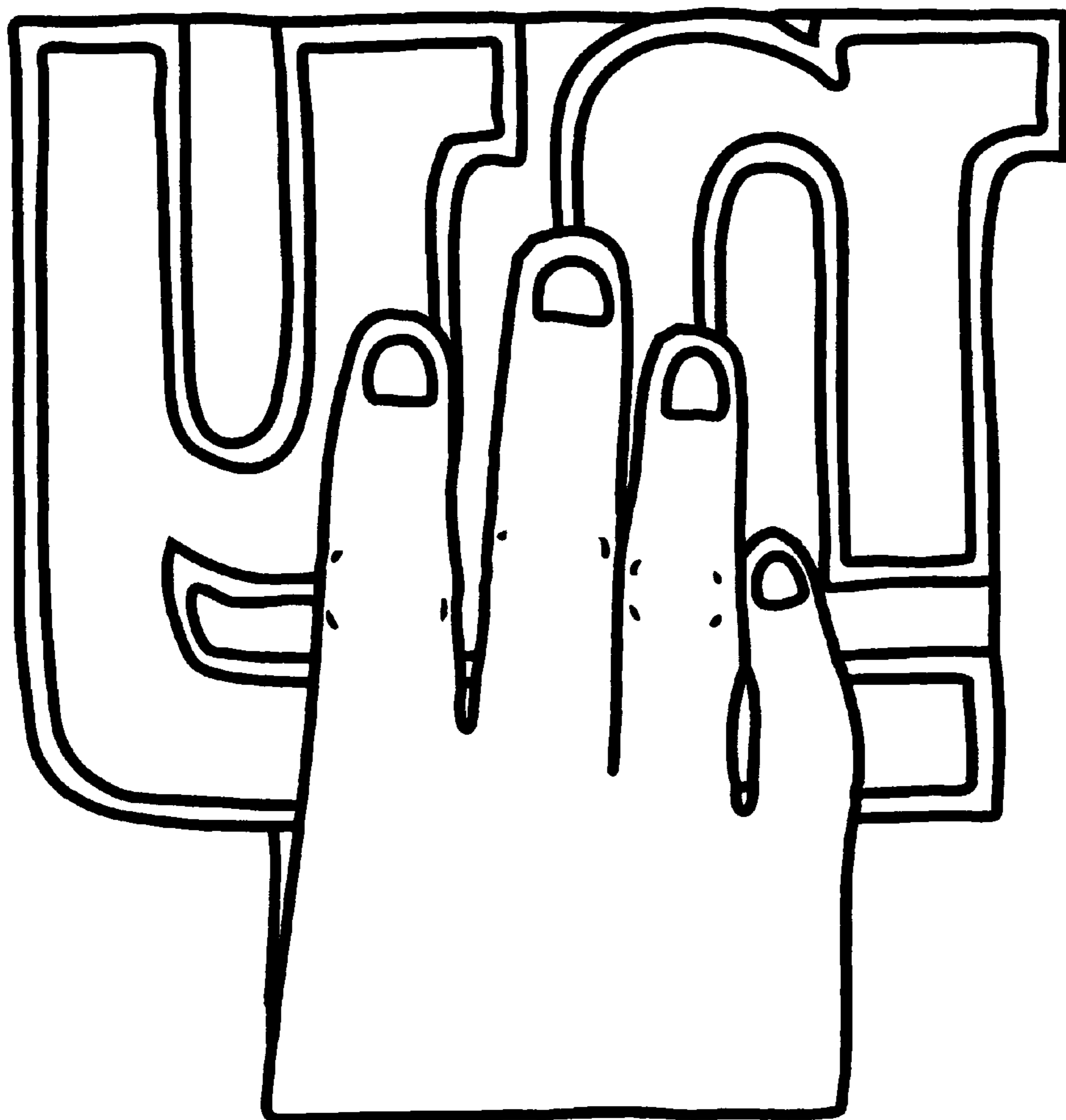

FIG. 10

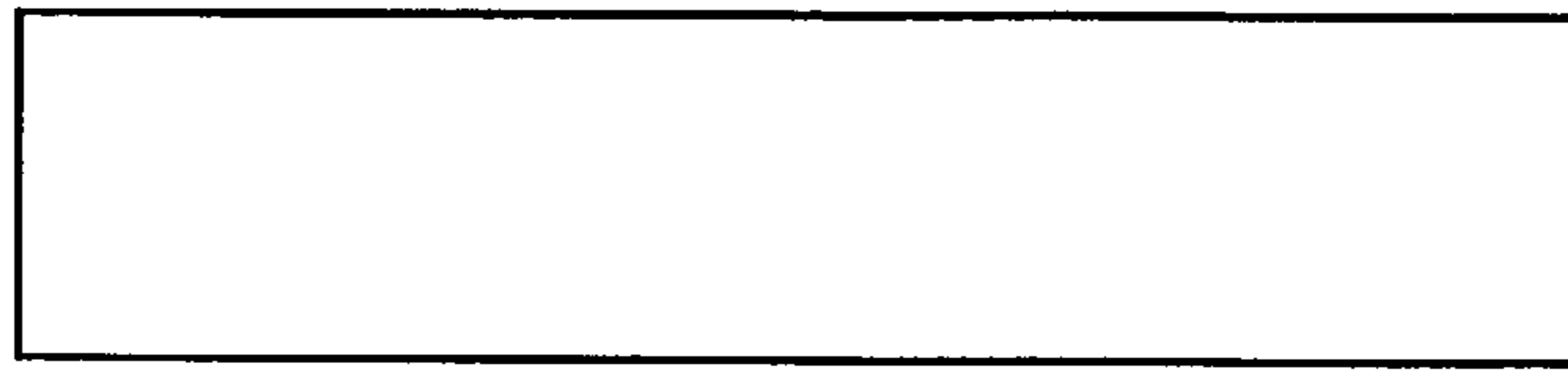

FIG. 12

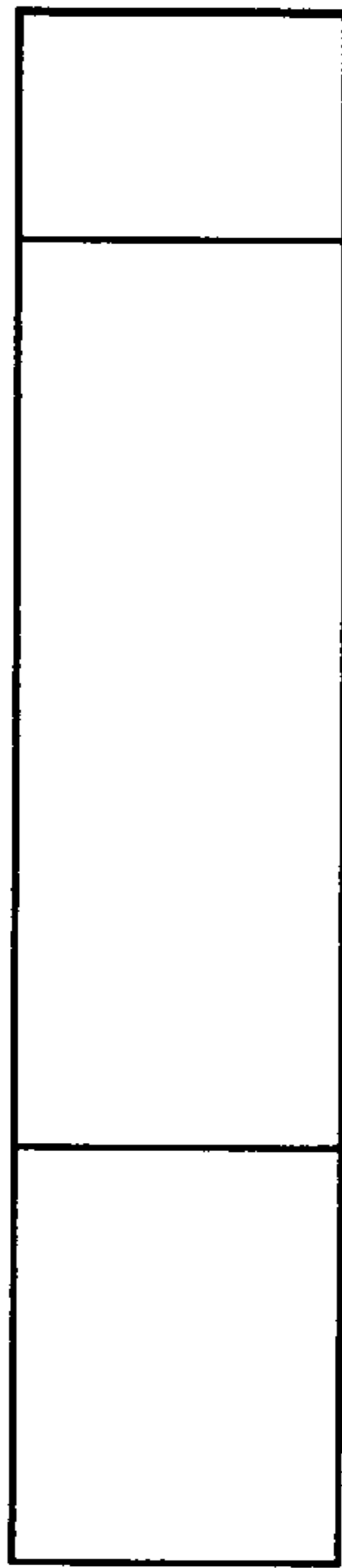

FIG. 11

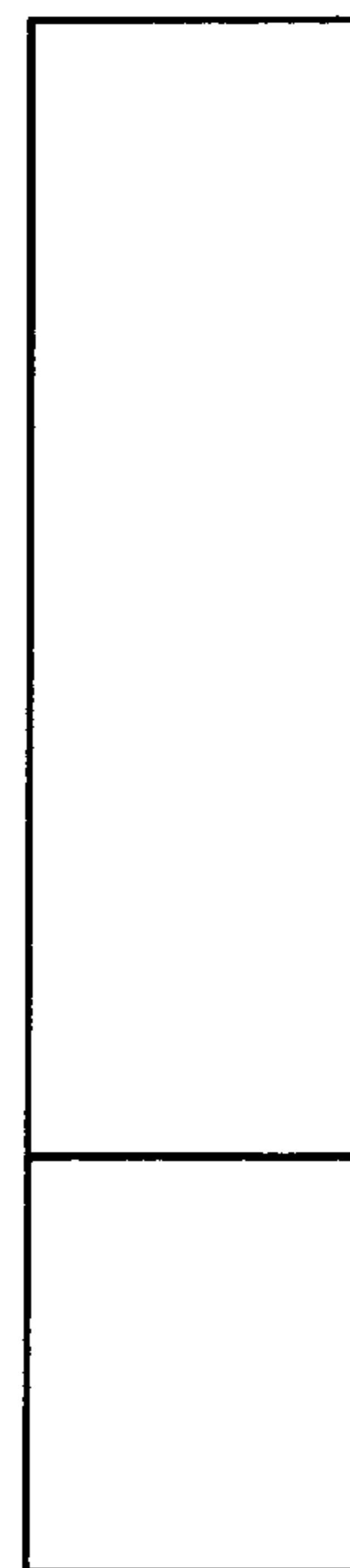

FIG. 14

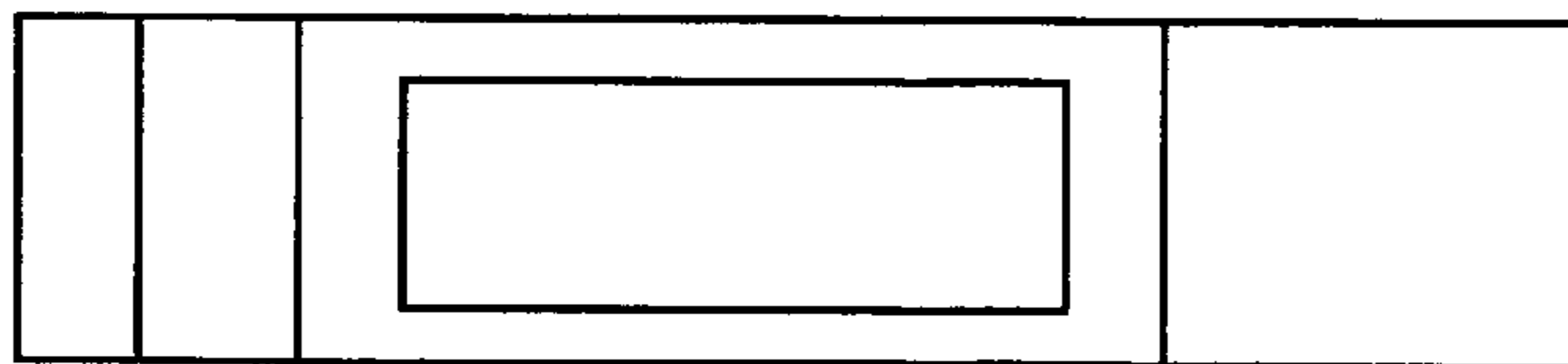

FIG. 13

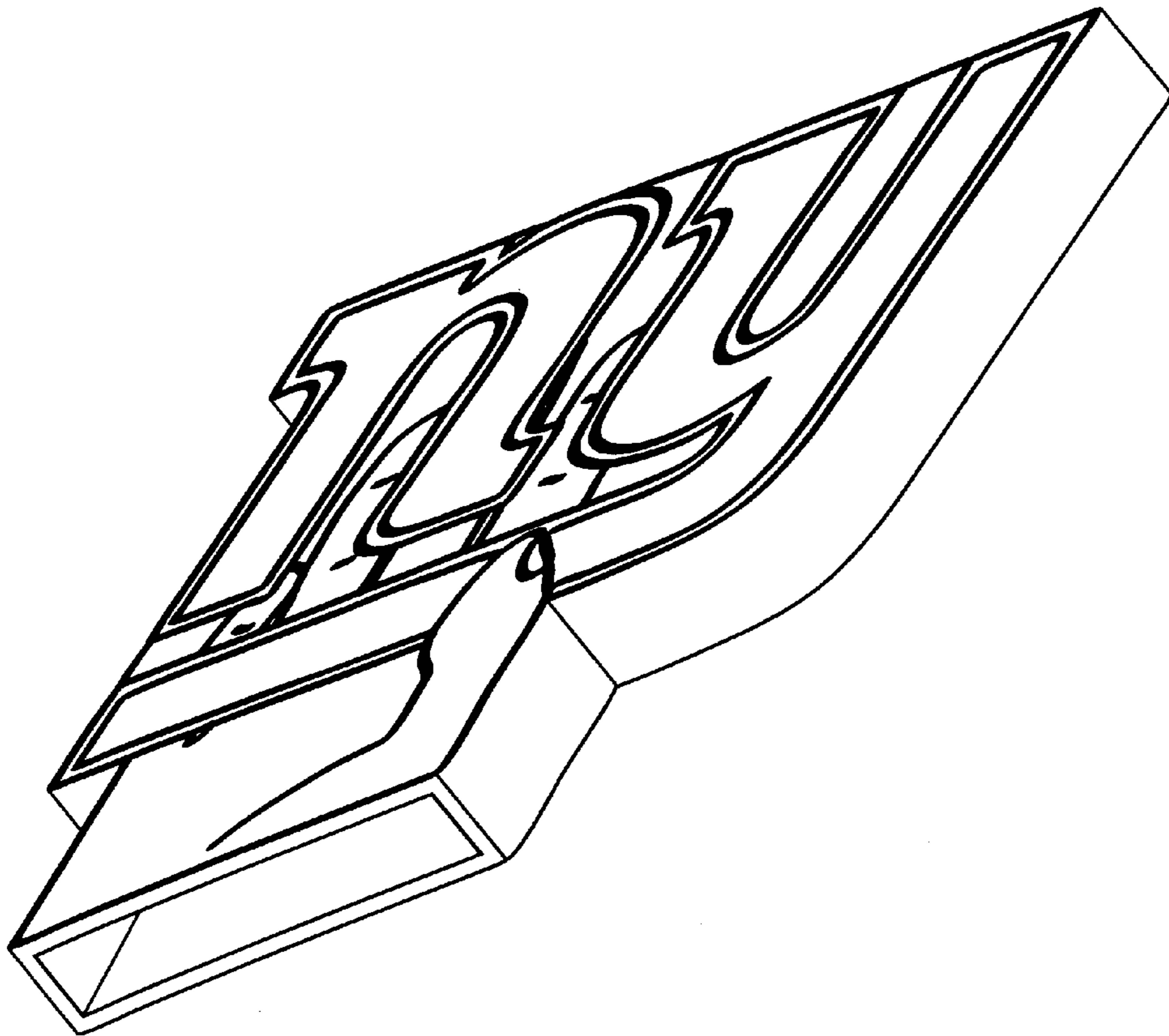

FIG. 15

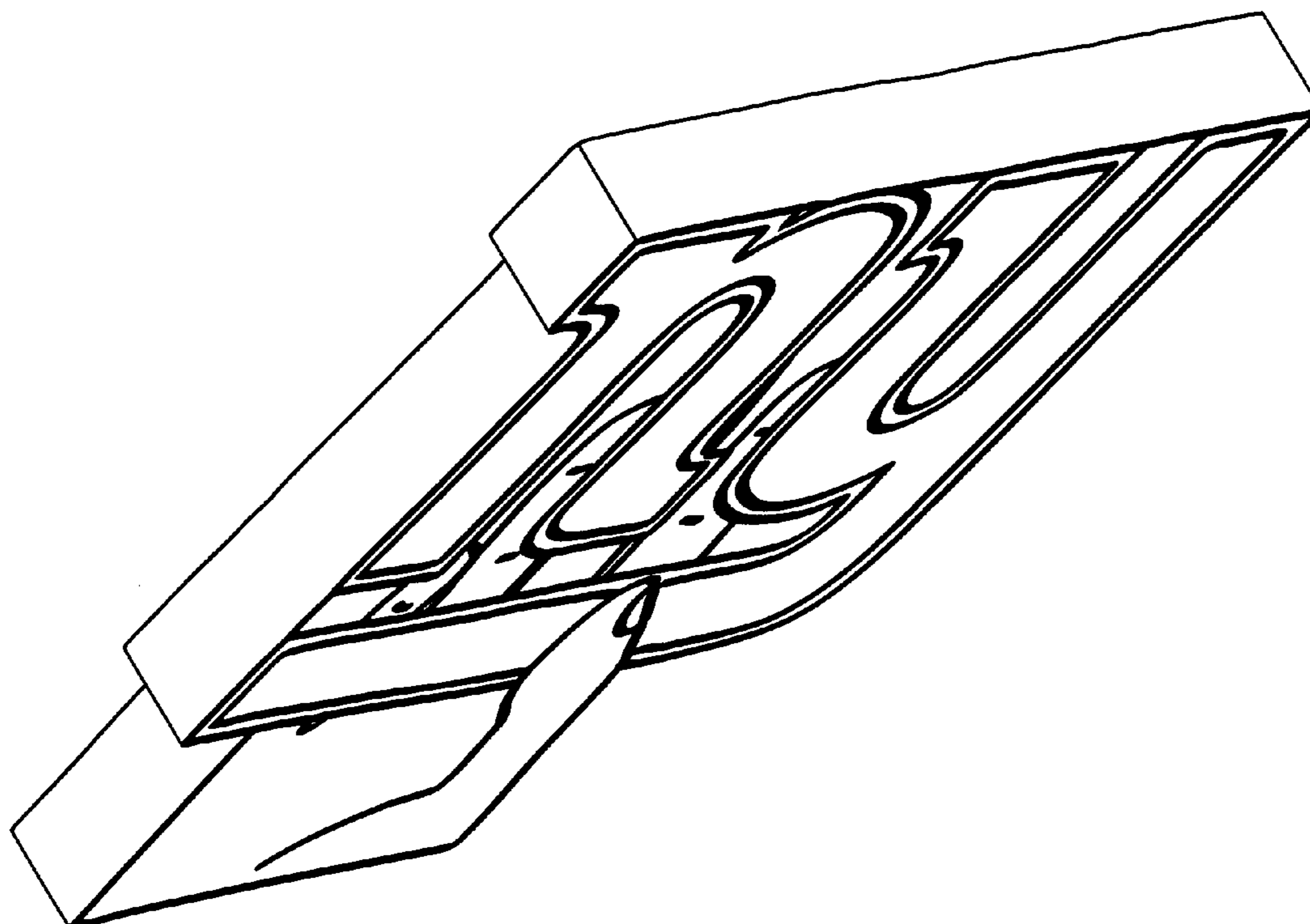

FIG. 16