

US00D665846S

(12) **United States Design Patent**
Chuang

(10) **Patent No.:** **US D665,846 S**

(45) **Date of Patent:** **** Aug. 21, 2012**

(54) **FILE ORGANIZER**

(75) Inventor: **Chih-Wei Chuang**, Edison, NJ (US)

(73) Assignee: **Officemate International Corp.**,
Edison, NJ (US)

(**) Term: **14 Years**

(21) Appl. No.: **29/373,494**

(22) Filed: **Apr. 14, 2011**

(51) **LOC (9) Cl.** **19-02**

(52) **U.S. Cl.** **D19/90**

(58) **Field of Classification Search** D3/304,
D3/314; D6/475, 512; D9/414, 425, 431;
D19/75, 77-92, 99, 100; 206/215, 435, 449,
206/558

See application file for complete search history.

(56) **References Cited**

U.S. PATENT DOCUMENTS

2,916,161	A	*	12/1959	Schaefer	211/126.2
D245,056	S	*	7/1977	Winther	D6/407
D249,617	S	*	9/1978	Bozicnik	D6/475
D251,586	S	*	4/1979	Levenhagen	D9/425
D270,678	S	*	9/1983	Stein	D3/304
D299,037	S	*	12/1988	Klodt	D19/90
5,072,576	A	*	12/1991	Evans	53/592
D322,993	S	*	1/1992	Hobson	D19/90
D330,130	S	*	10/1992	Evans	D6/457

D333,051	S	*	2/1993	Craft et al.	D6/475
D348,394	S	*	7/1994	Dreyer	D9/425
D390,270	S	*	2/1998	Cheris et al.	D19/90
D423,823	S	*	5/2000	Nelson	D6/475
D436,728	S	*	1/2001	Harding	D3/304
D486,644	S	*	2/2004	Claypool	D3/304
D537,121	S	*	2/2007	Smith	D19/90
D604,769	S	*	11/2009	Chen et al.	D19/90
D648,801	S	*	11/2011	Chuang	D19/92
D648,802	S	*	11/2011	Chuang	D19/92
D651,405	S	*	1/2012	Lee	D3/304

* cited by examiner

Primary Examiner — Elizabeth Albert

(74) *Attorney, Agent, or Firm* — Daniel Kirshner

(57) **CLAIM**

The ornamental design for a file organizer, as shown and described.

DESCRIPTION

FIG. 1 is a front perspective view of an file organizer showing the new design;

FIG. 2 is a front perspective view thereof;

FIG. 3 is a right side view thereof;

FIG. 4 is a left side view thereof;

FIG. 5 is a front view thereof;

FIG. 6 is a back view thereof;

FIG. 7 is a top view thereof; and,

FIG. 8 is a bottom view thereof.

1 Claim, 8 Drawing Sheets

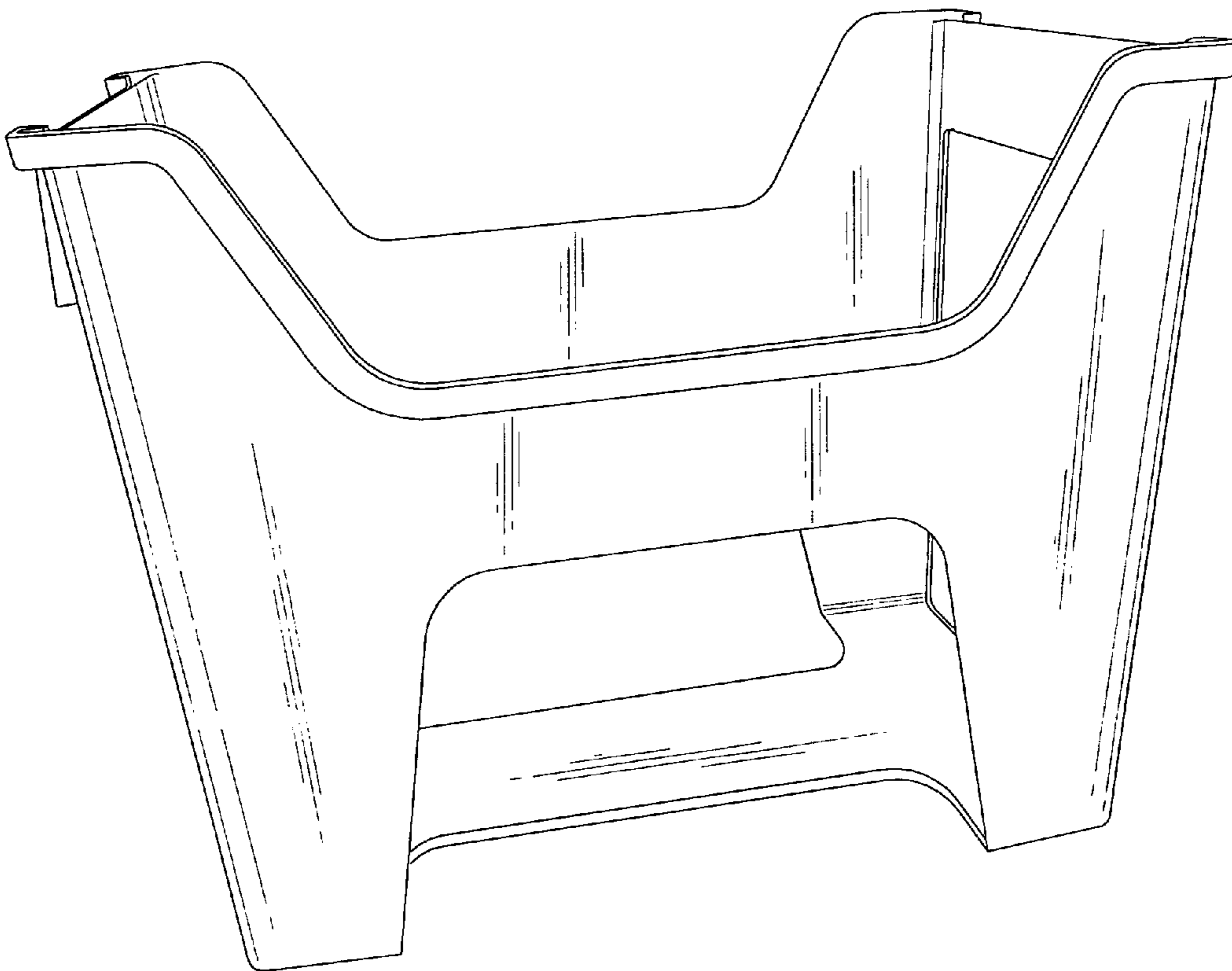

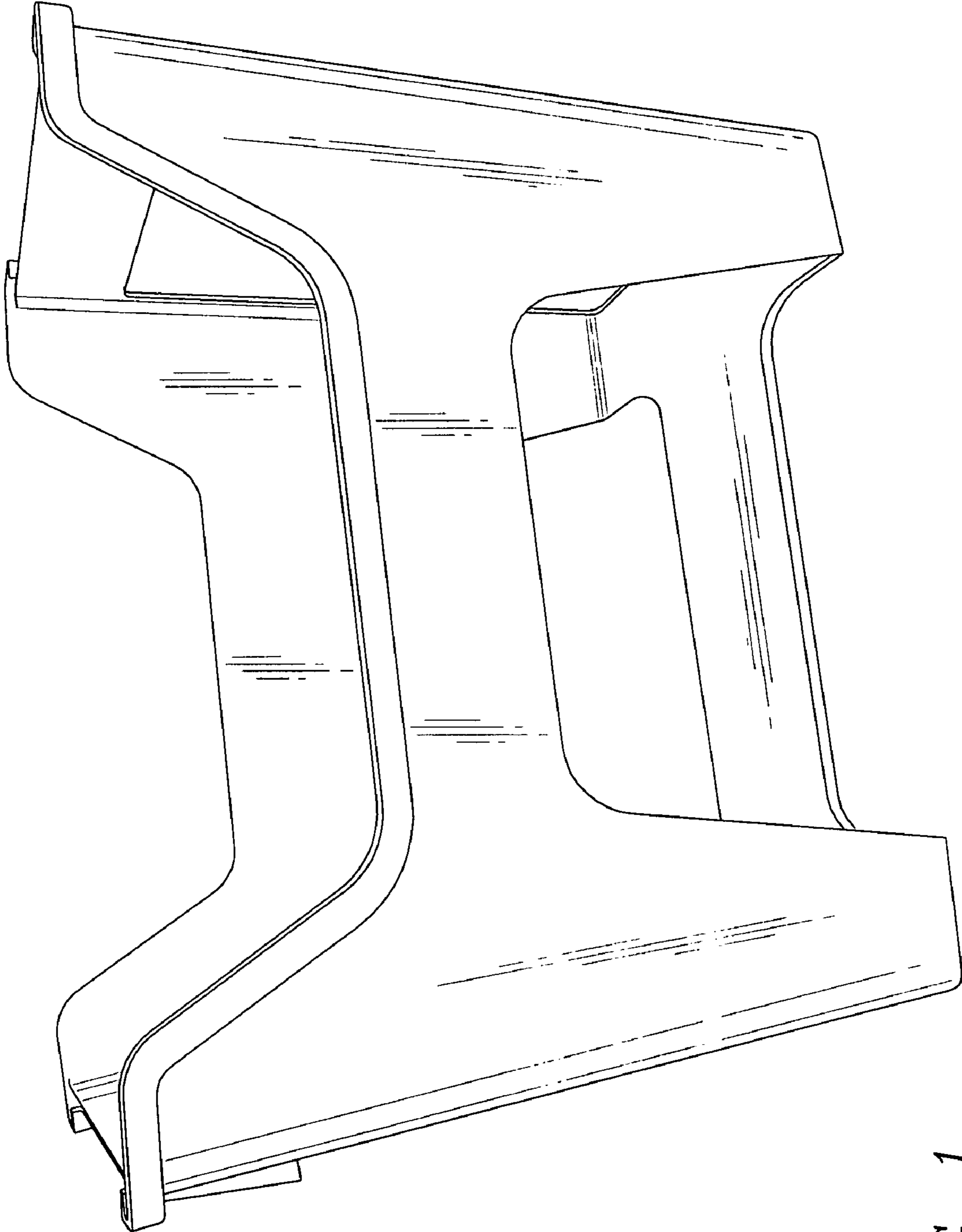

FIG. 1

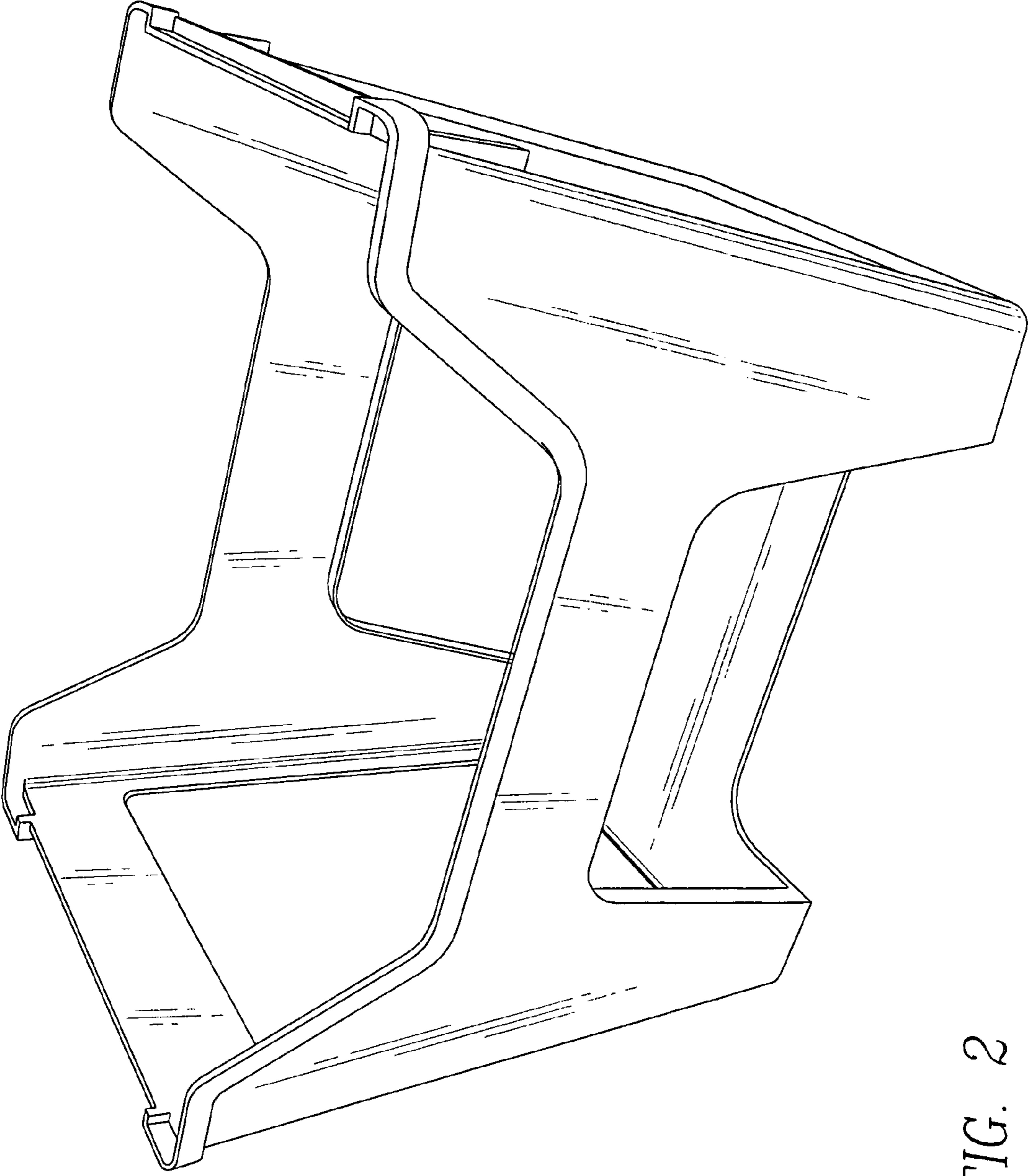

FIG. 2

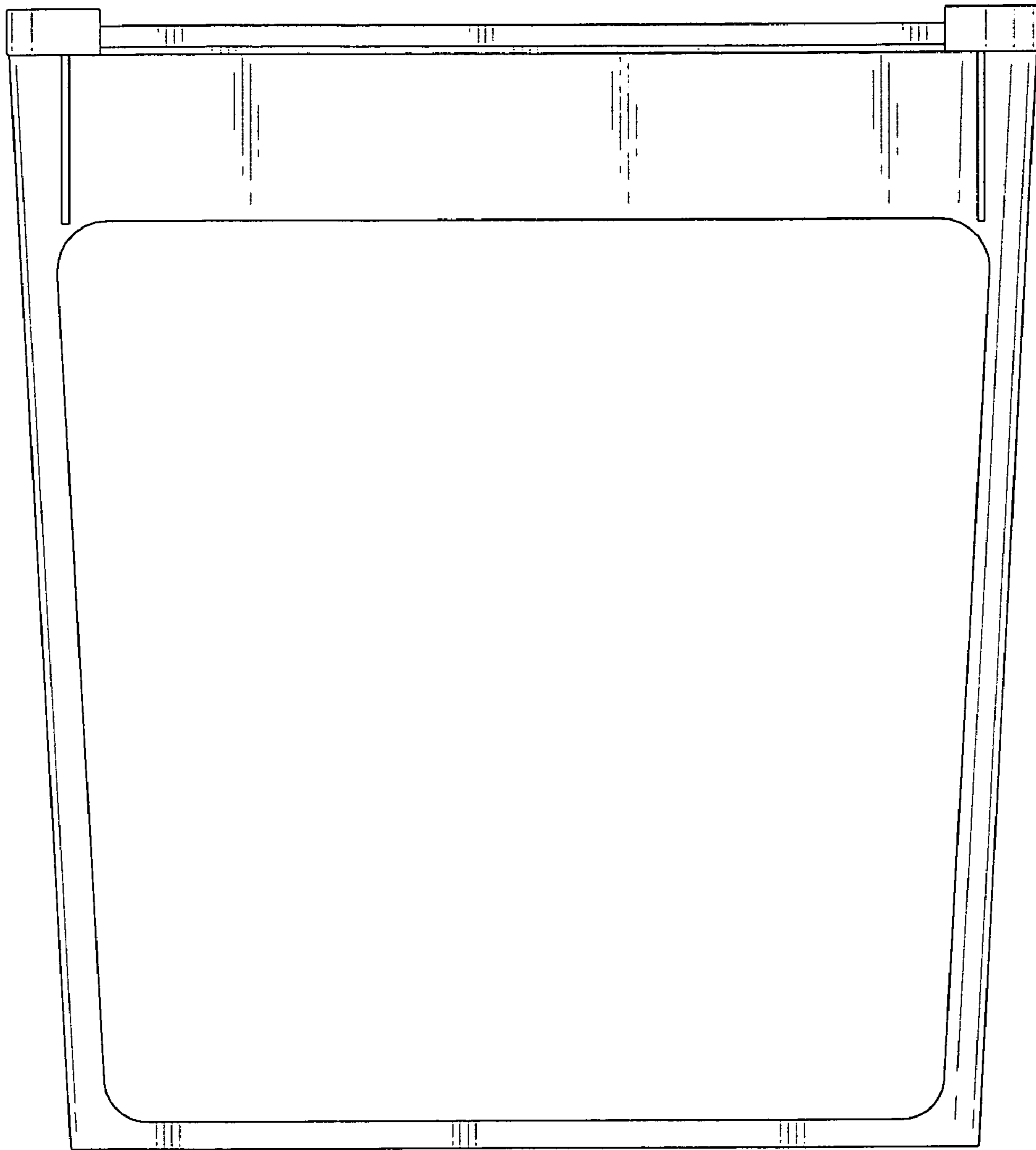

FIG. 3

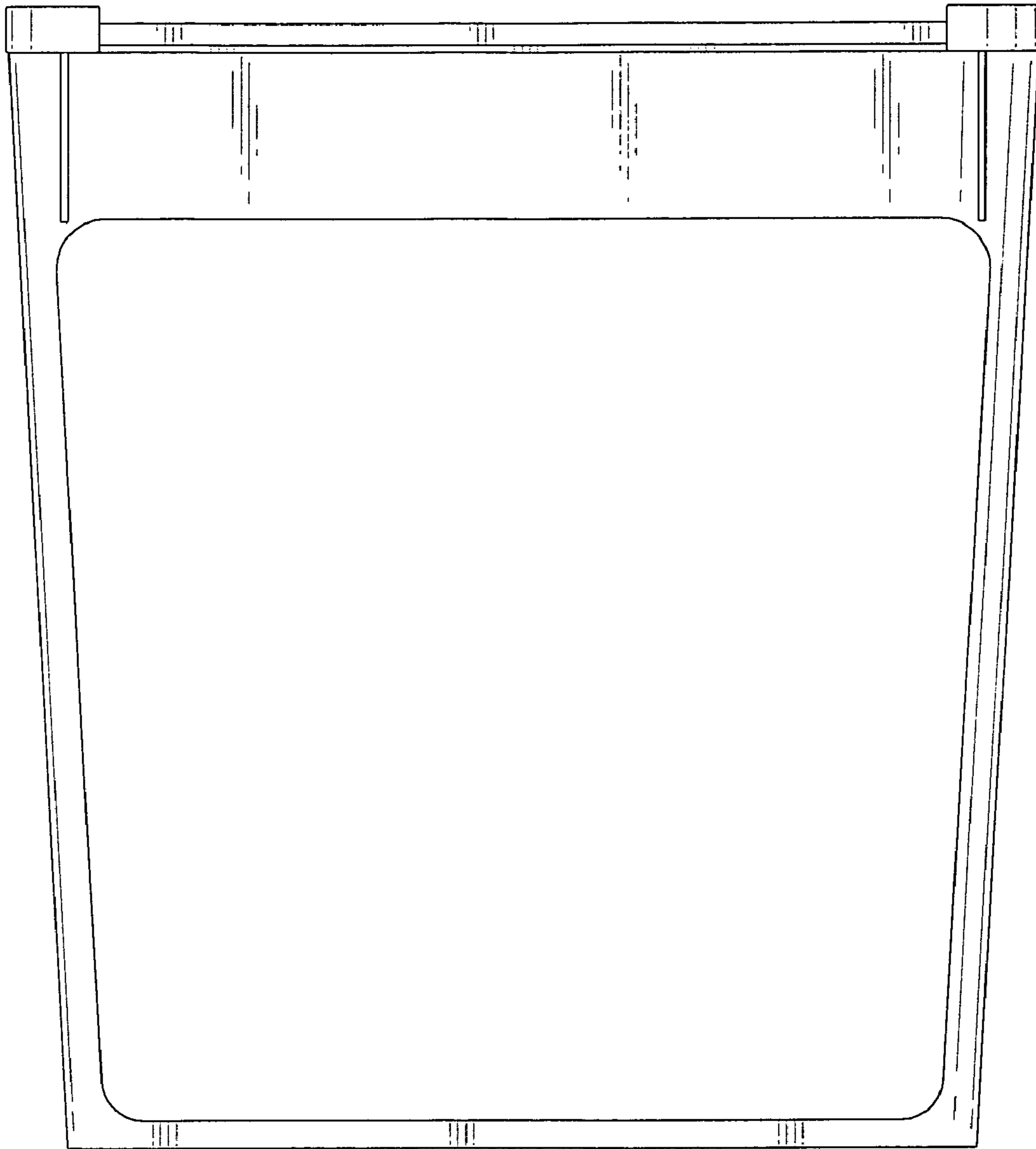

FIG. 4

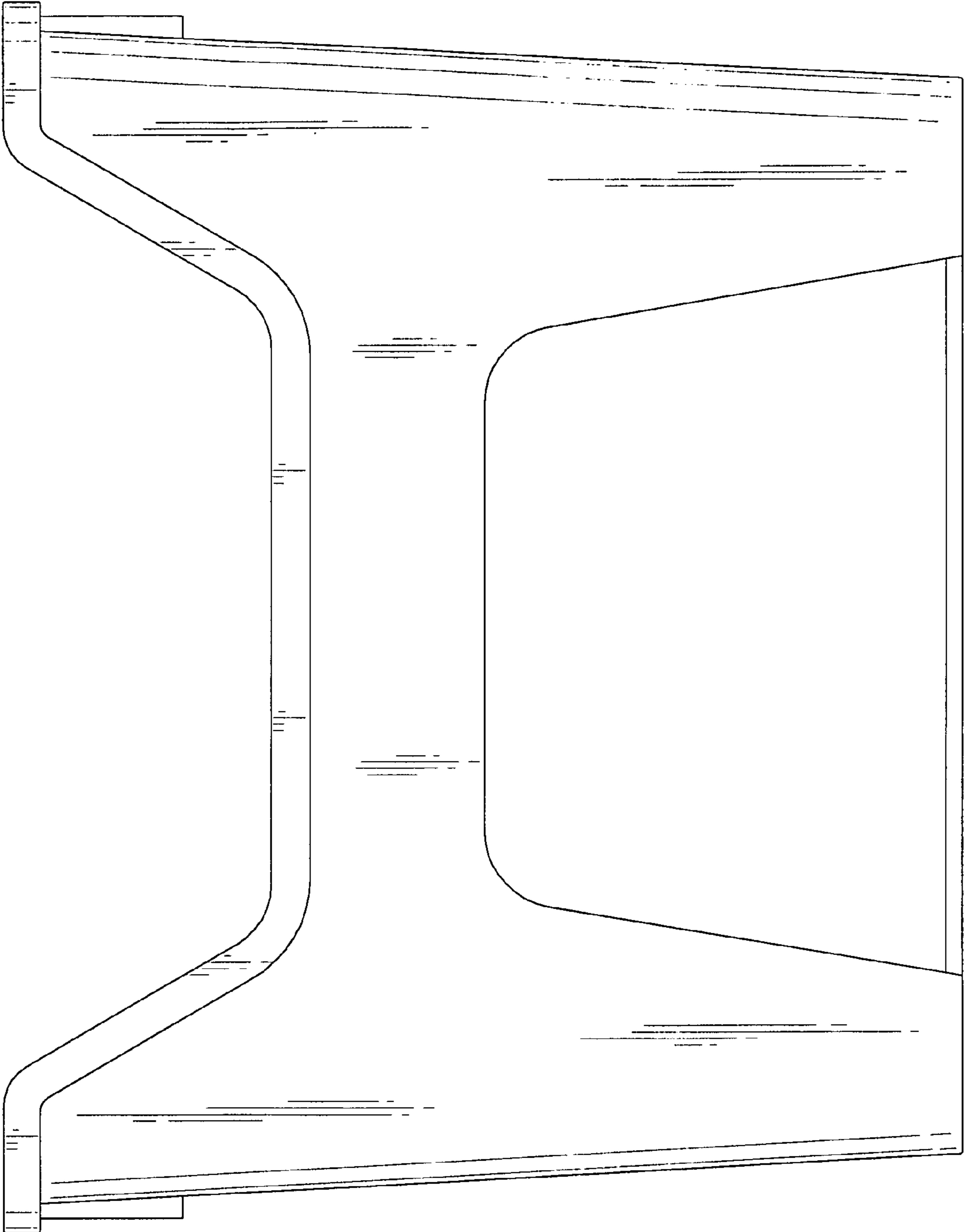

FIG. 5

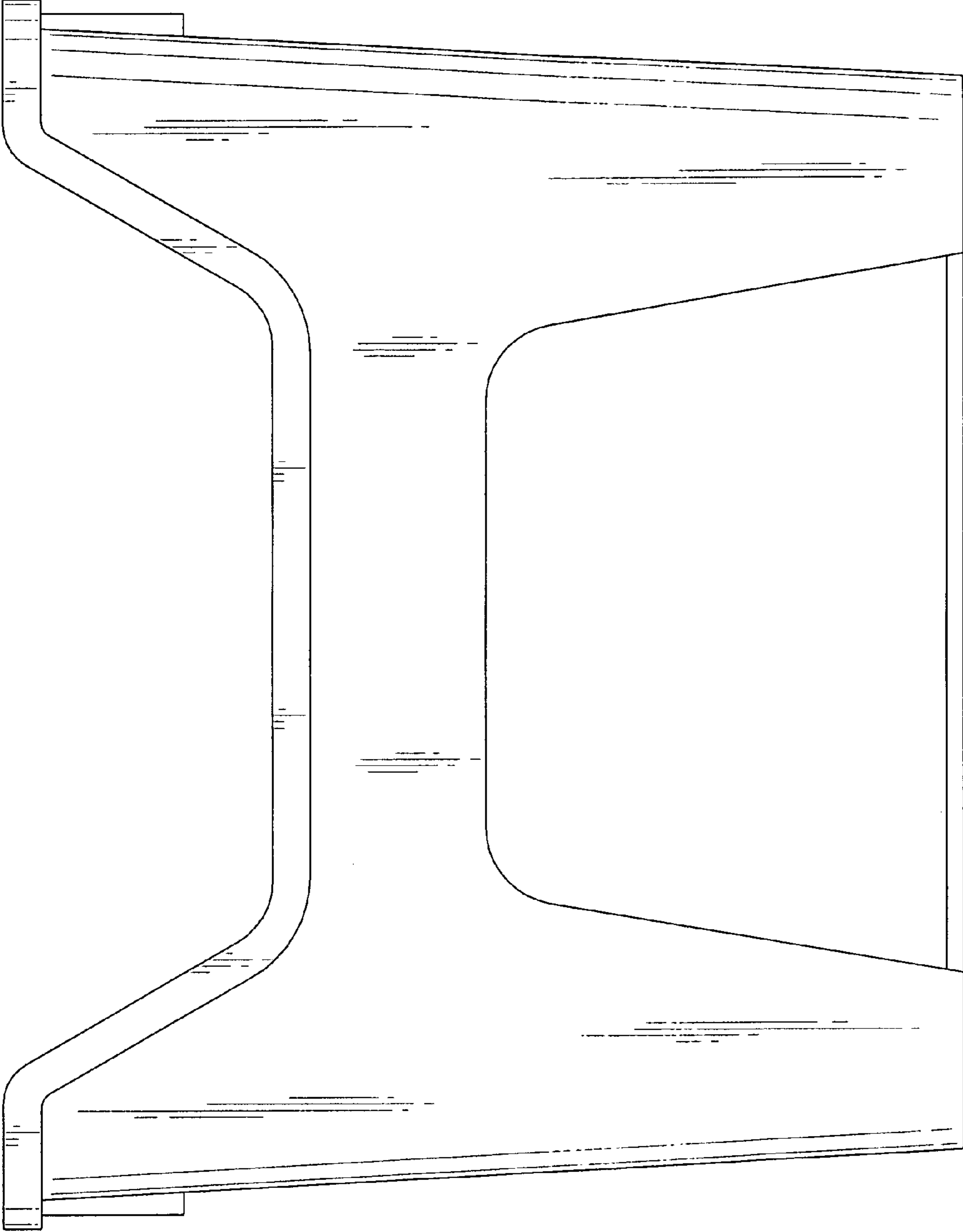

FIG. 6

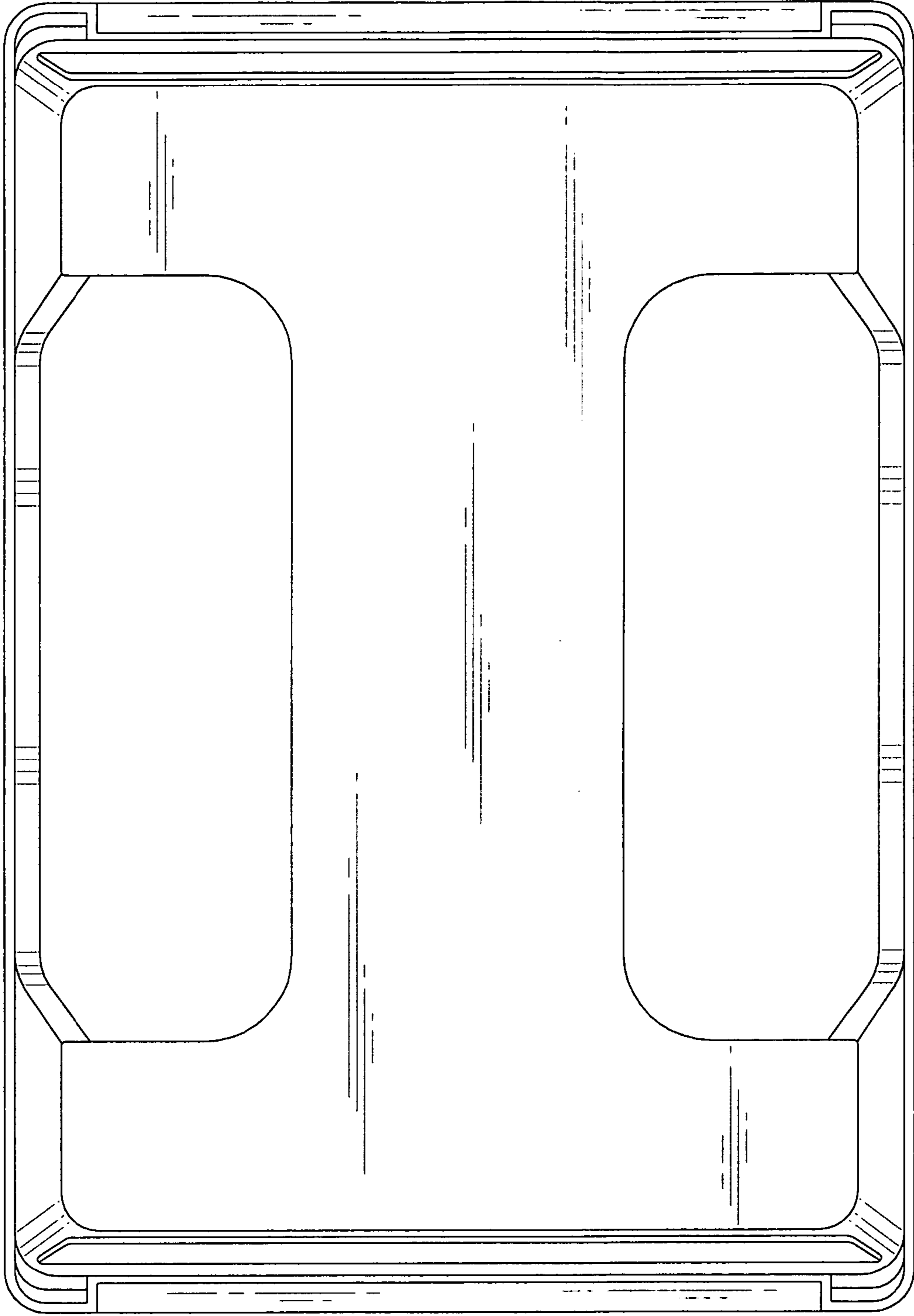

FIG. 7

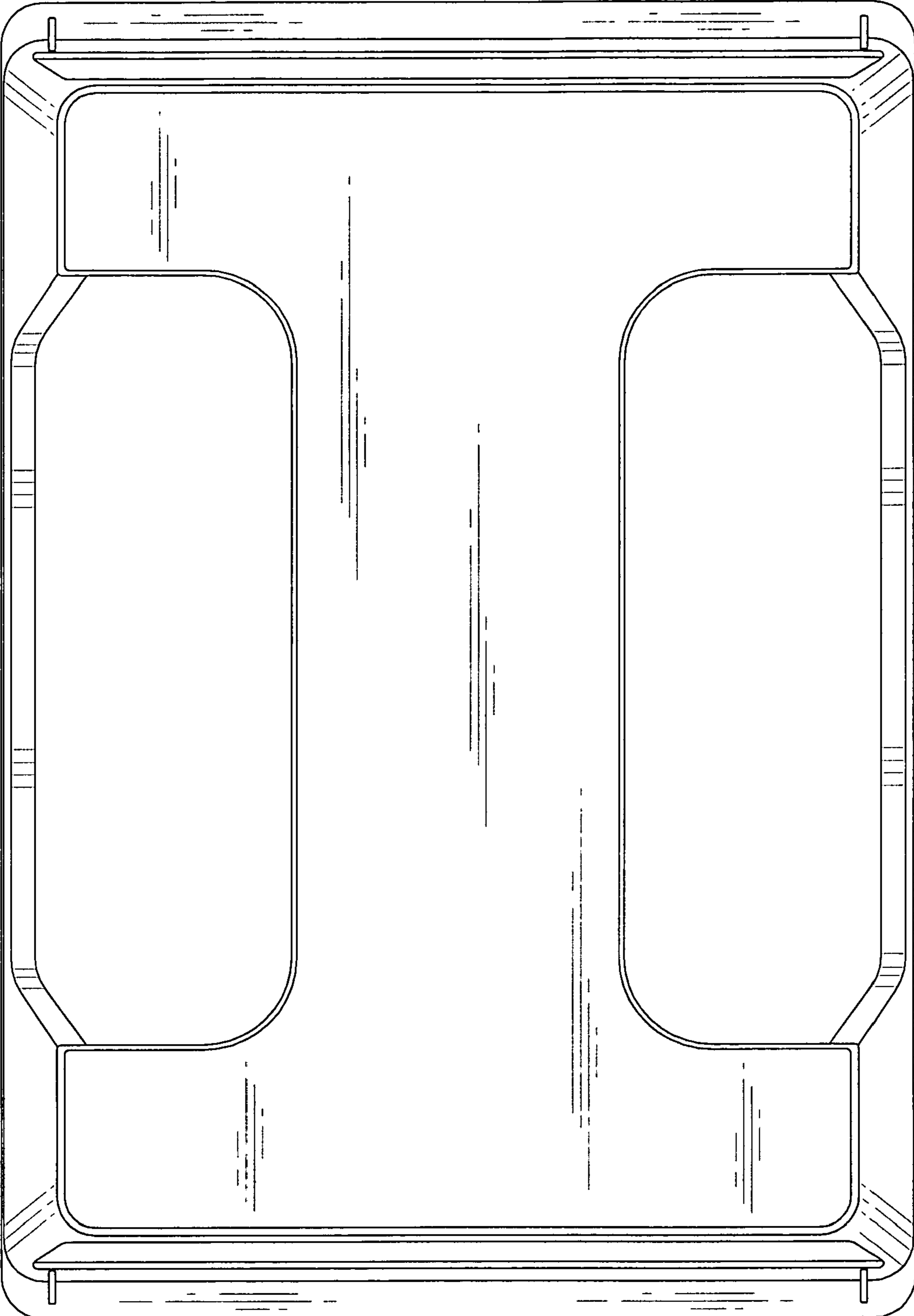

FIG. 8