



US00D665713S

(12) **United States Design Patent**  
**Pochurek et al.**

(10) **Patent No.:** **US D665,713 S**

(45) **Date of Patent:** **\*\* Aug. 21, 2012**

(54) **STEP BAR FOR VEHICLE**

(75) Inventors: **Scott K. Pochurek**, Temecula, CA (US);  
**Robert L. West**, Seal Beach, CA (US)

(73) Assignee: **Westin Automotive Products**,  
Irwindale, CA (US)

(\*\*) Term: **14 Years**

(21) Appl. No.: **29/412,348**

(22) Filed: **Feb. 2, 2012**

(51) **LOC (9) Cl.** ..... **12-16**

(52) **U.S. Cl.** ..... **D12/203**

(58) **Field of Classification Search** ..... D12/203,  
D12/162; D6/582-586, 592-594; 280/163-164.1,  
280/169; 15/215-217; 428/138.141; 296/97.23  
See application file for complete search history.

(56) **References Cited**

U.S. PATENT DOCUMENTS

D495,283 S *	8/2004	Ashley et al.	.....	D12/203
D505,901 S *	6/2005	Wang	.....	D12/203
D532,354 S *	11/2006	Storer	.....	D12/203
D535,928 S *	1/2007	Crandall	.....	D12/203
D536,290 S *	2/2007	Yeh	.....	D12/203
D545,747 S *	7/2007	Storer	.....	D12/203
D546,745 S *	7/2007	Storer	.....	D12/203
D568,222 S *	5/2008	Storer	.....	D12/203
7,717,444 B2 *	5/2010	Fichter	.....	280/163

D634,687 S *	3/2011	Vukel	.....	D12/203
D645,805 S *	9/2011	Vukel	.....	D12/203
D649,100 S *	11/2011	Cheng	.....	D12/203

\* cited by examiner

*Primary Examiner* — Stacia Cadmus

(74) *Attorney, Agent, or Firm* — Dobrusin & Thennisch PC

(57) **CLAIM**

The ornamental design of a step bar for vehicle, as shown and described.

**DESCRIPTION**

FIG. 1 is a perspective view of a step bar for vehicle showing our new design, shown in its position of use secure to a vehicle;

FIG. 2 is an enlarged perspective view of the step bar for vehicle;

FIG. 3 is a top plan view of FIG. 2;

FIG. 4 is a bottom plan view of FIG. 2;

FIG. 5 is an enlarged front elevation view of FIG. 2;

FIG. 6 is an enlarged rear elevation view of FIG. 2;

FIG. 7 is an enlarged fragmentary top plan view of one of the step hoops of FIG. 2;

FIG. 8 is an enlarged top plan view of one of the step pieces of FIG. 2 shown separately for ease of illustration; and,

FIG. 9 is an enlarged fragmentary top plan view of one of the step hoops of FIG. 2 with the step piece removed for ease of illustration.

The broken lines showing of environment is for illustrative purposes only and forms no part of the claimed design.

**1 Claim, 3 Drawing Sheets**

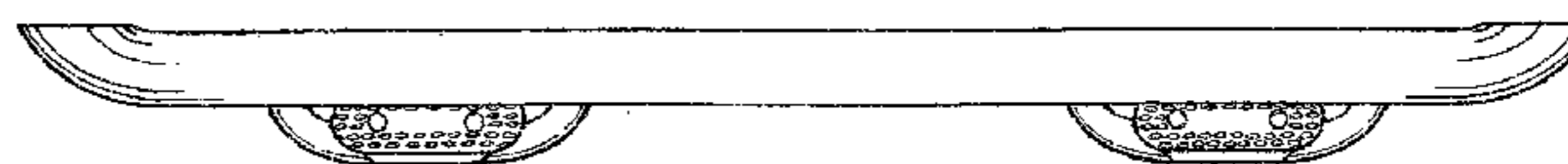
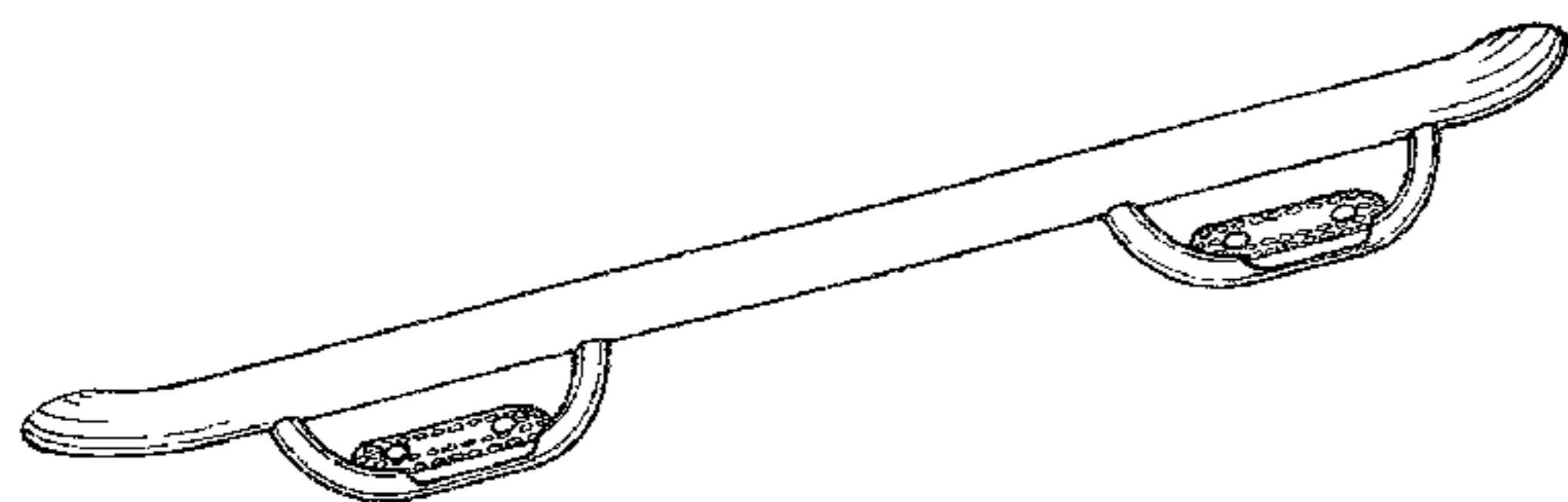

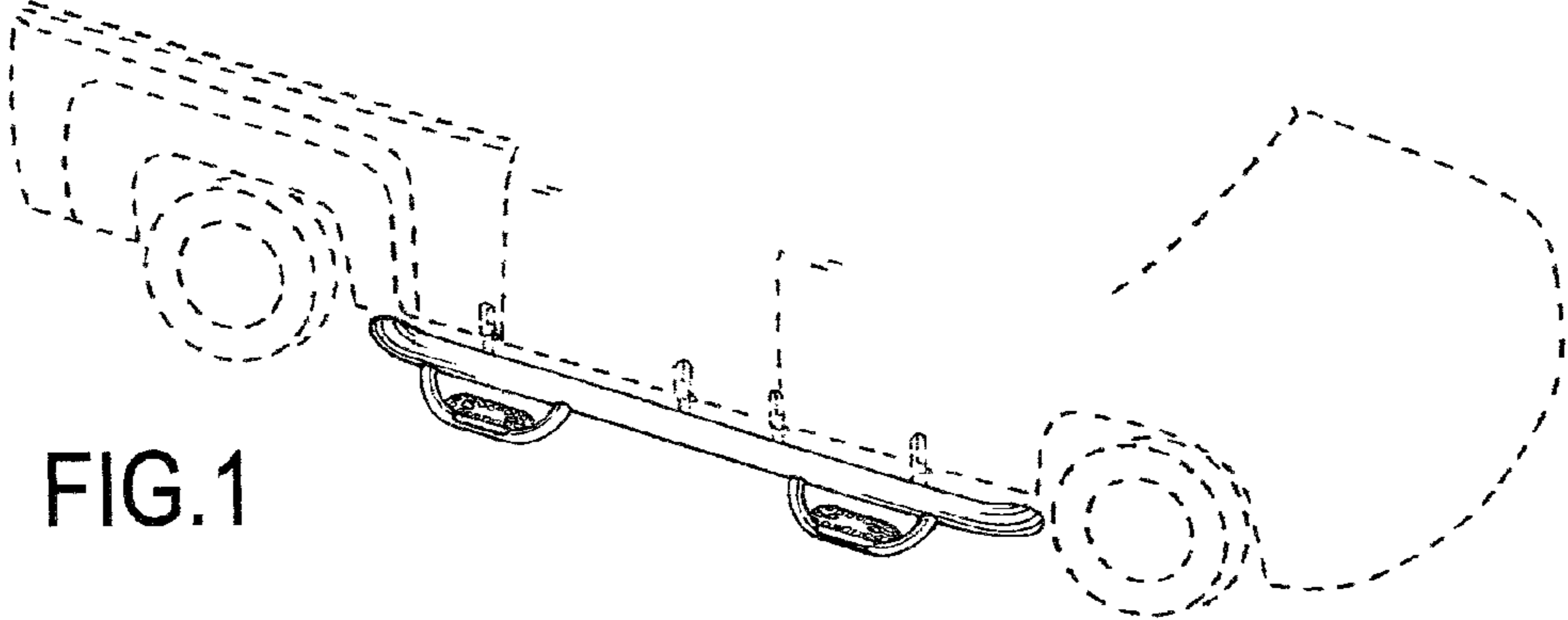

FIG.1

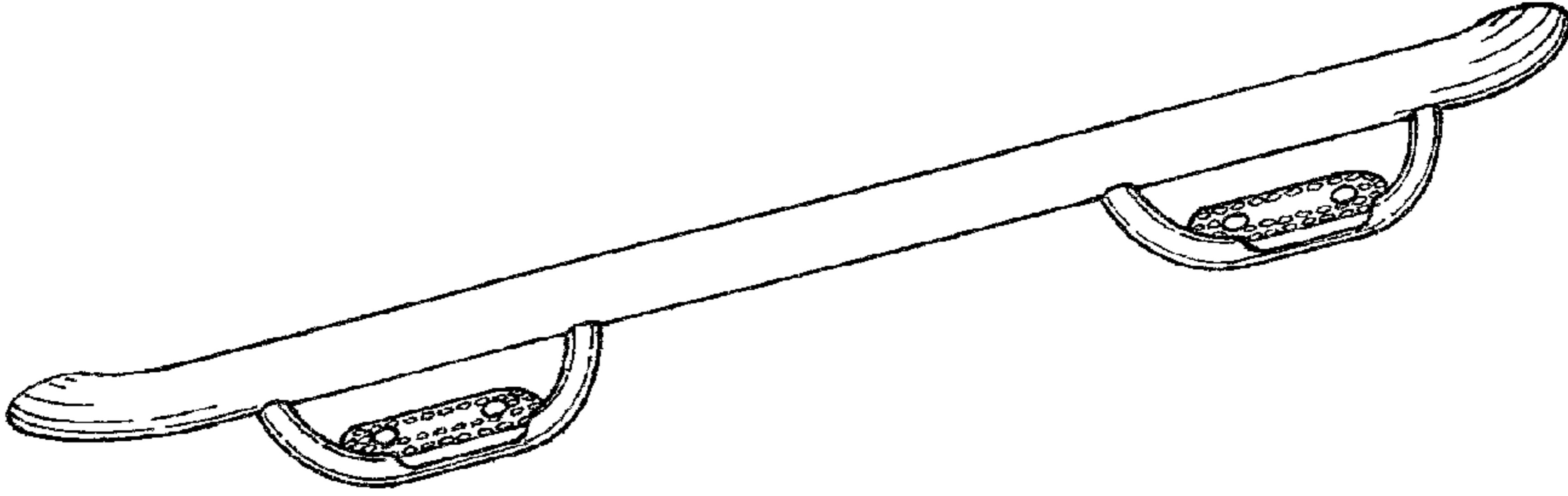

FIG.2

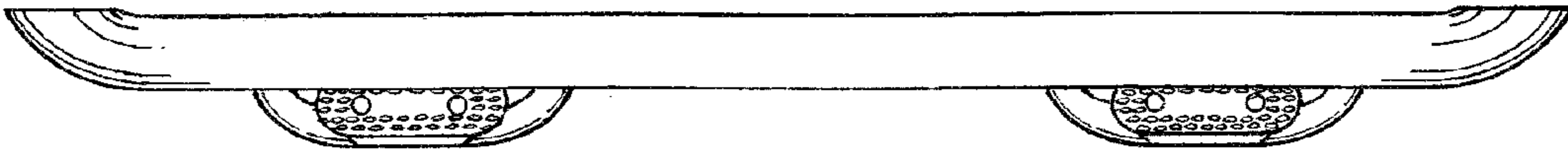

FIG.3

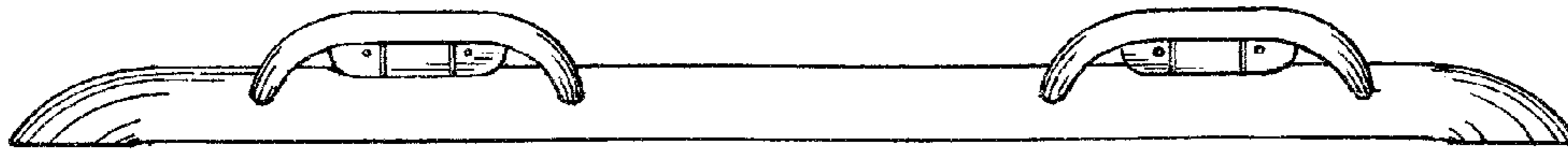

FIG. 4

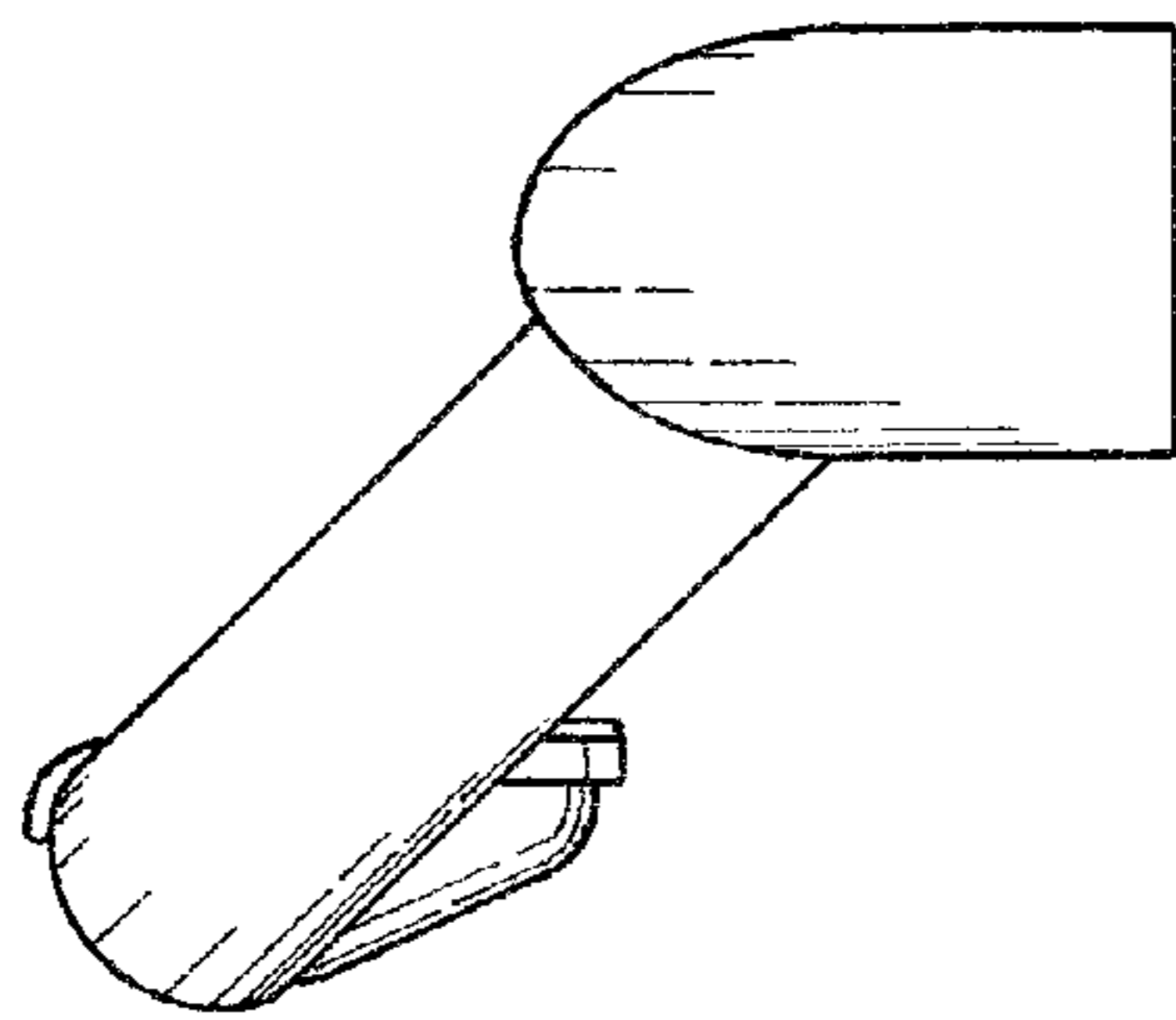

FIG. 5

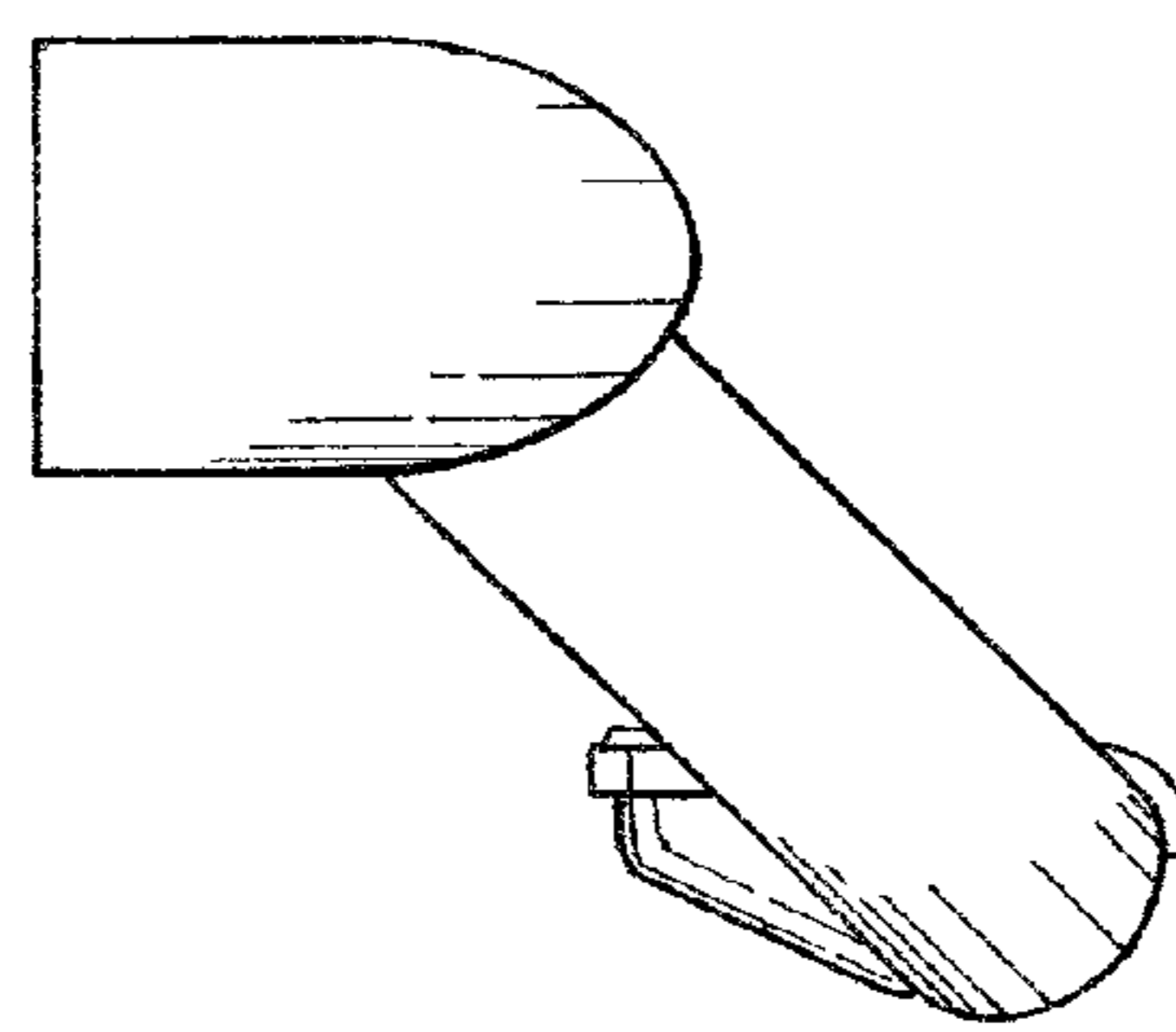

FIG. 6

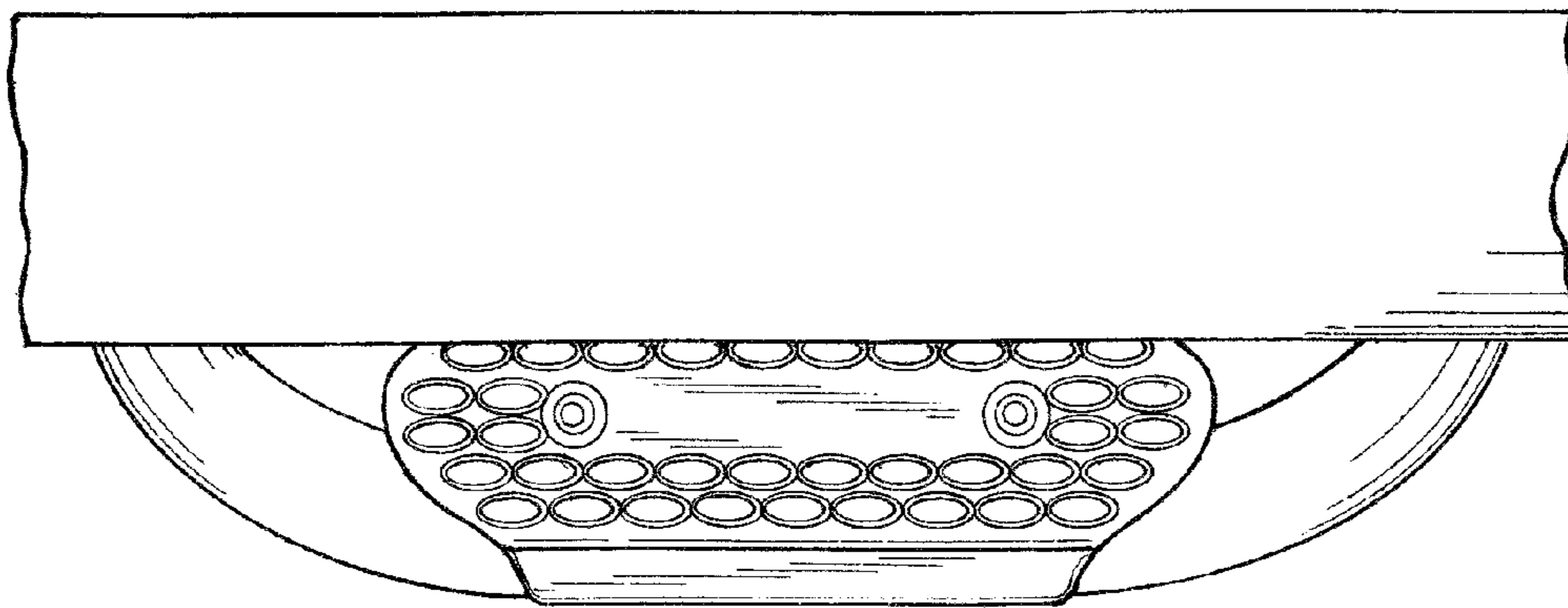

FIG. 7

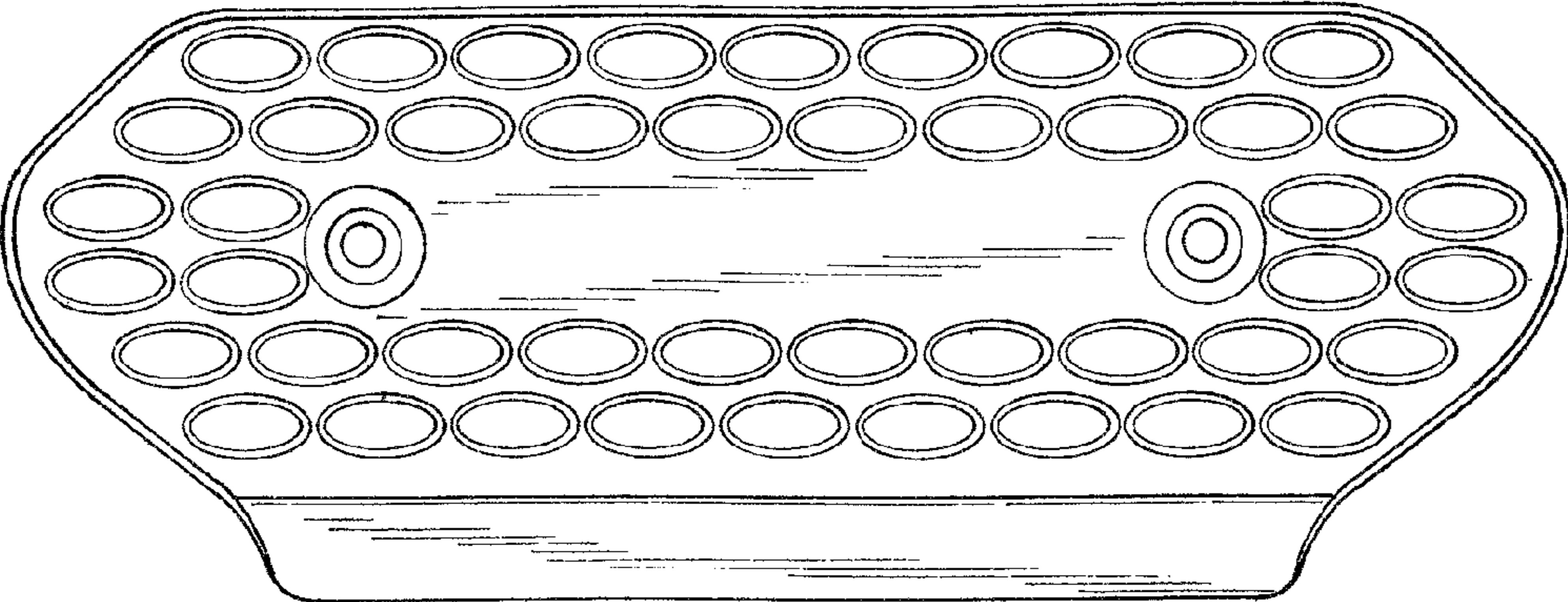

FIG. 8

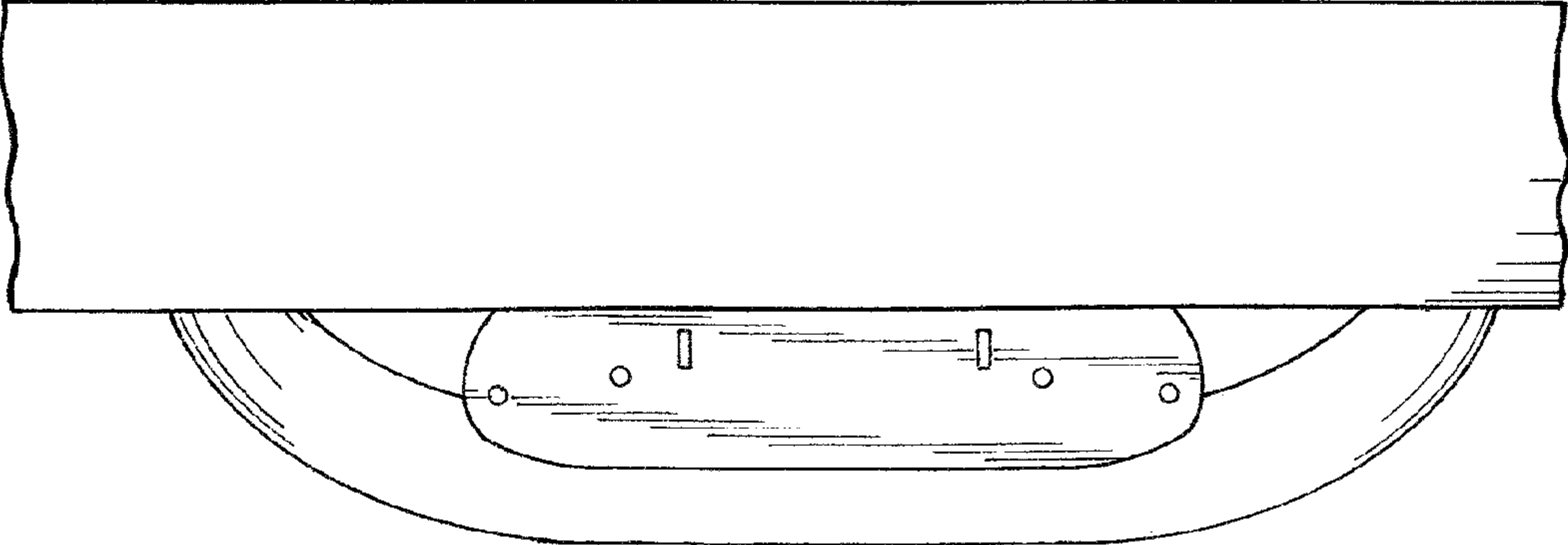

FIG. 9