



US00D665550S

(12) **United States Design Patent**
Connor et al.

(10) **Patent No.:** **US D665,550 S**
(45) **Date of Patent:** **** Aug. 14, 2012**

(54) **BAG SUPPORT**

Primary Examiner — Cynthia Ramirez

(76) Inventors: **Patrick Connor**, Kitchener (CA); **Alan James Jones**, Waterloo (CA); **Leobino Alvernaz**, Cambridge (CA); **Glenn Penney**, Kitchener (CA); **JoAnne Loree**, Kitchener (CA)

(57) **CLAIM**
The ornamental design for a bag support, as shown and described.

(**) Term: **14 Years**

(21) Appl. No.: **29/387,555**

(22) Filed: **Mar. 15, 2011**

(51) **LOC (9) Cl.** **09-09**

(52) **U.S. Cl.** **D34/5**

(58) **Field of Classification Search** D34/1,
D34/5, 6; 248/95, 97, 98, 99, 100
See application file for complete search history.

DESCRIPTION

FIG. 1 is a front right perspective view of a bag support exemplary of an embodiment of the design;
FIG. 2 is a left side view of the bag support of FIG. 1;
FIG. 3 is a right side view of the bag support of FIG. 1;
FIG. 4 is a rear view of the bag support of FIG. 1;
FIG. 5 is a front view of the bag support of FIG. 1;
FIG. 6 is a bottom view of the bag support of FIG. 1;
FIG. 7 is a top view of the bag support of FIG. 1;
FIG. 8 is a front right perspective view of the bag support of FIG. 1 holding a bag;
FIG. 9 is a front right perspective view of a bag support exemplary of another embodiment of the design;
FIG. 10 is a left side view of the bag support of FIG. 9;
FIG. 11 is a right side view of the bag support of FIG. 9;
FIG. 12 is a rear view of the bag support of FIG. 9;
FIG. 13 is a front view of the bag support of FIG. 9;
FIG. 14 is a bottom view of the bag support of FIG. 9;
FIG. 15 is a top view of the bag support of FIG. 9; and,
FIG. 16 is a front right side perspective view of the bag support of FIG. 9 holding a bag.
The broken line showing of a bag is included for the purpose of illustrating environment and forms no part of the claimed design.

(56) **References Cited**

U.S. PATENT DOCUMENTS

D216,437	S	*	1/1970	Vosbikian	D34/6
4,467,989	A	*	8/1984	Stroh	248/97
4,893,769	A	*	1/1990	Rotelli	248/97
D326,172	S	*	5/1992	Biesele et al.	D34/5
5,213,291	A	*	5/1993	Wiebe	248/97
D341,688	S	*	11/1993	Binkley et al.	D34/5
5,427,340	A	*	6/1995	Stromsmoe et al.	248/97
D389,632	S	*	1/1998	Reddin	D34/6
D398,121	S	*	9/1998	Siu	D34/6
D418,653	S	*	1/2000	Kent, Jr.	D34/6
D546,522	S	*	7/2007	Naujoks	D34/6
D568,023	S	*	4/2008	McConnell	D34/6

* cited by examiner

1 Claim, 10 Drawing Sheets

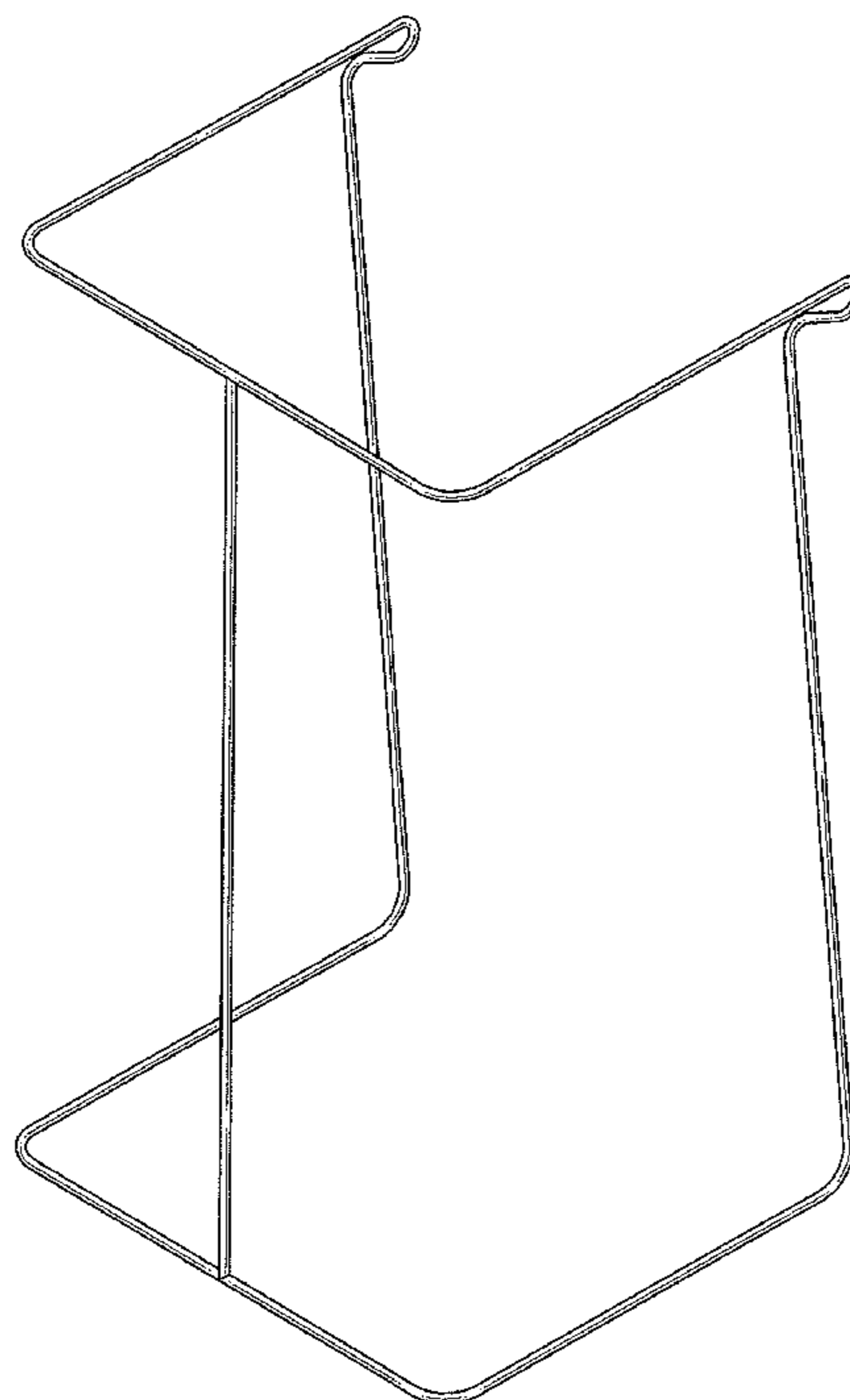

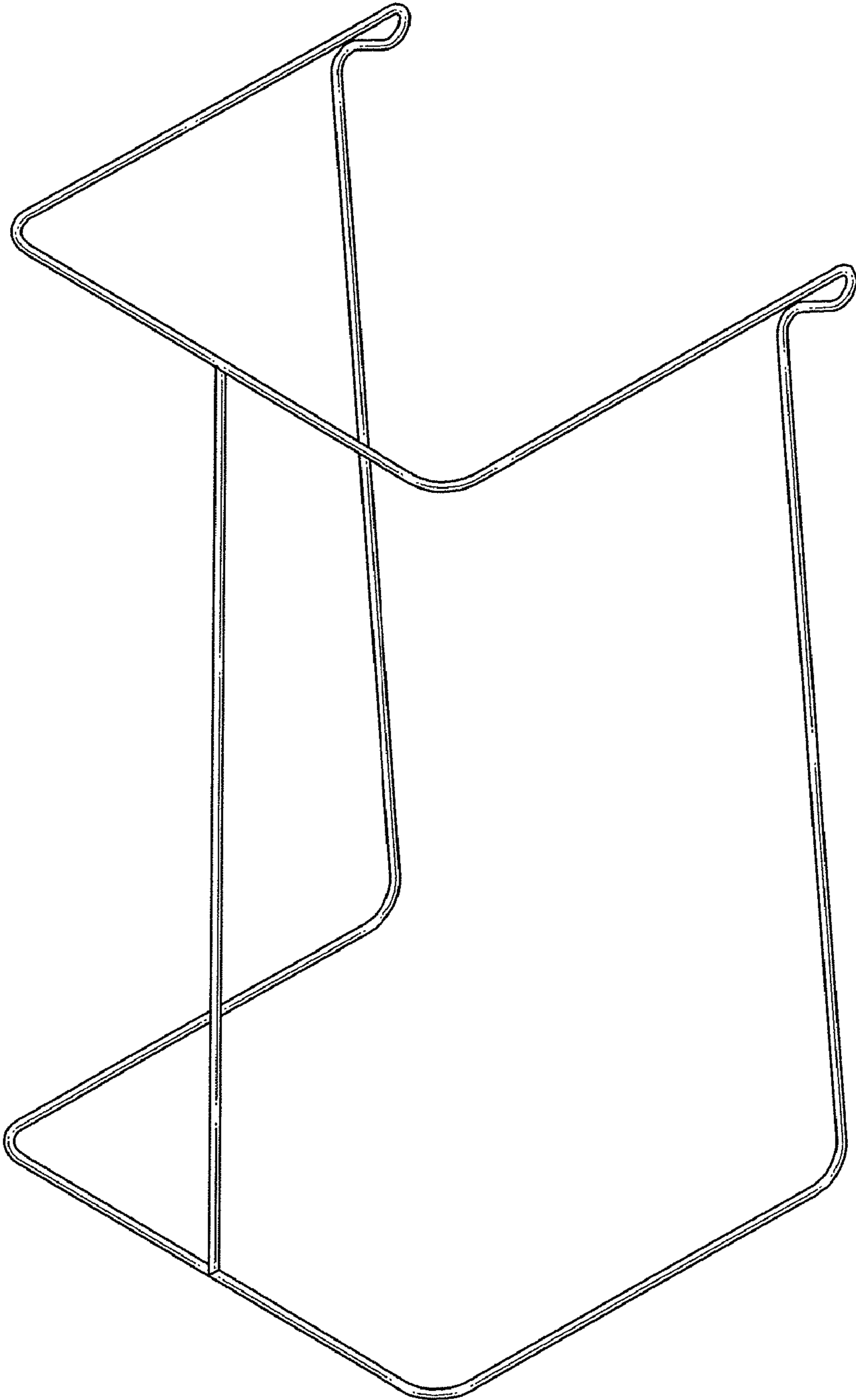

FIG. 1

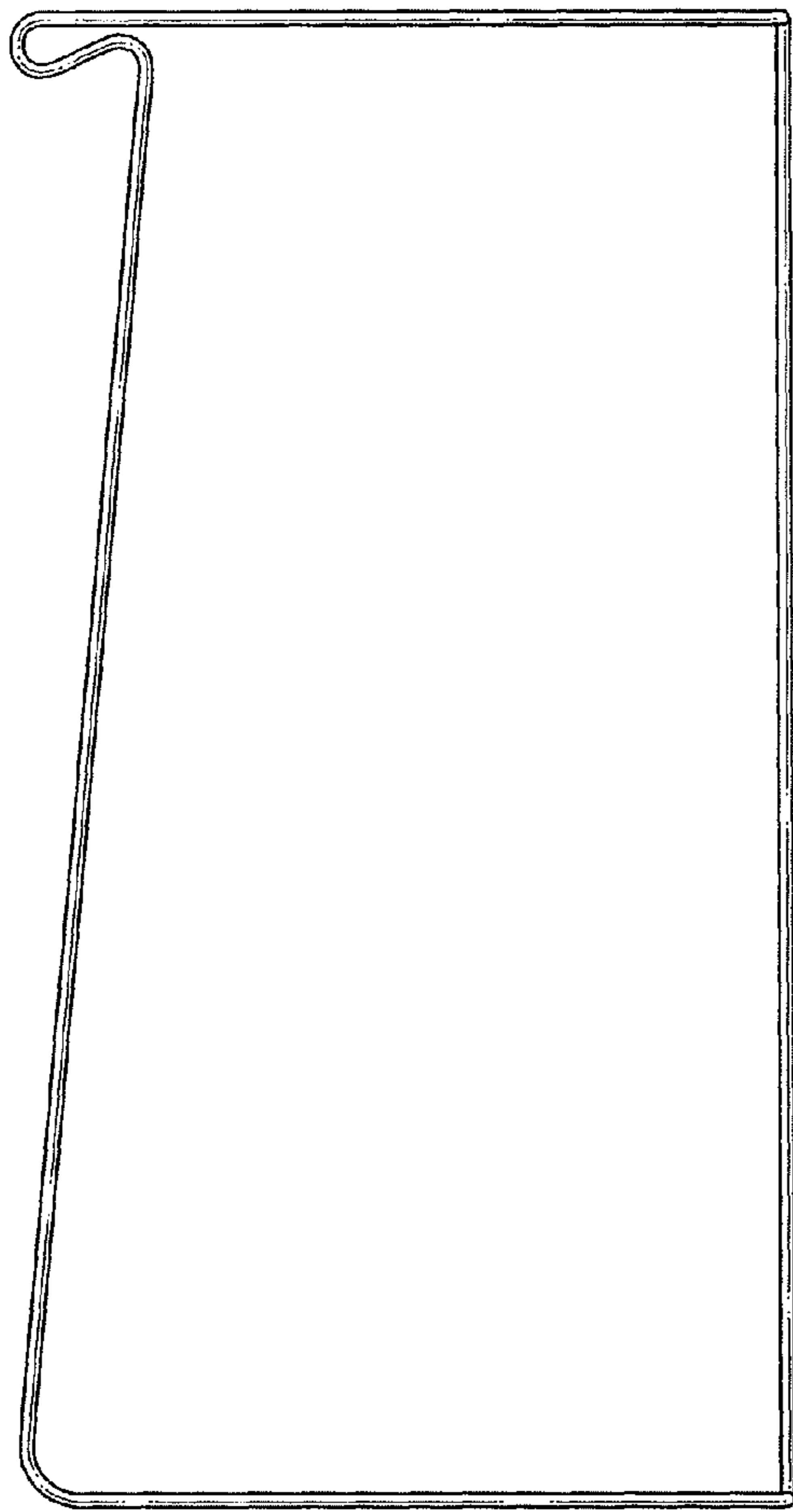

FIG. 2

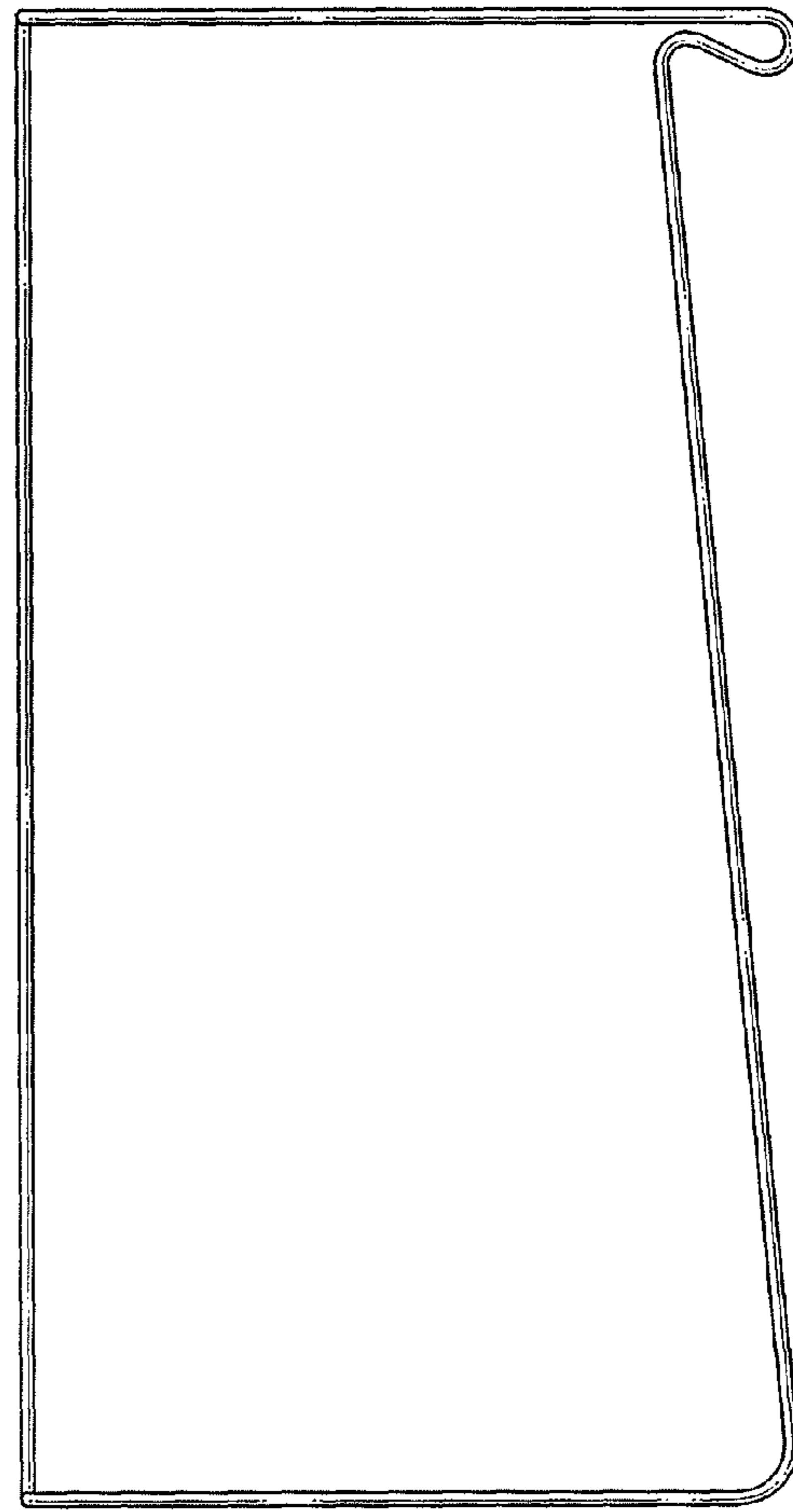

FIG. 3

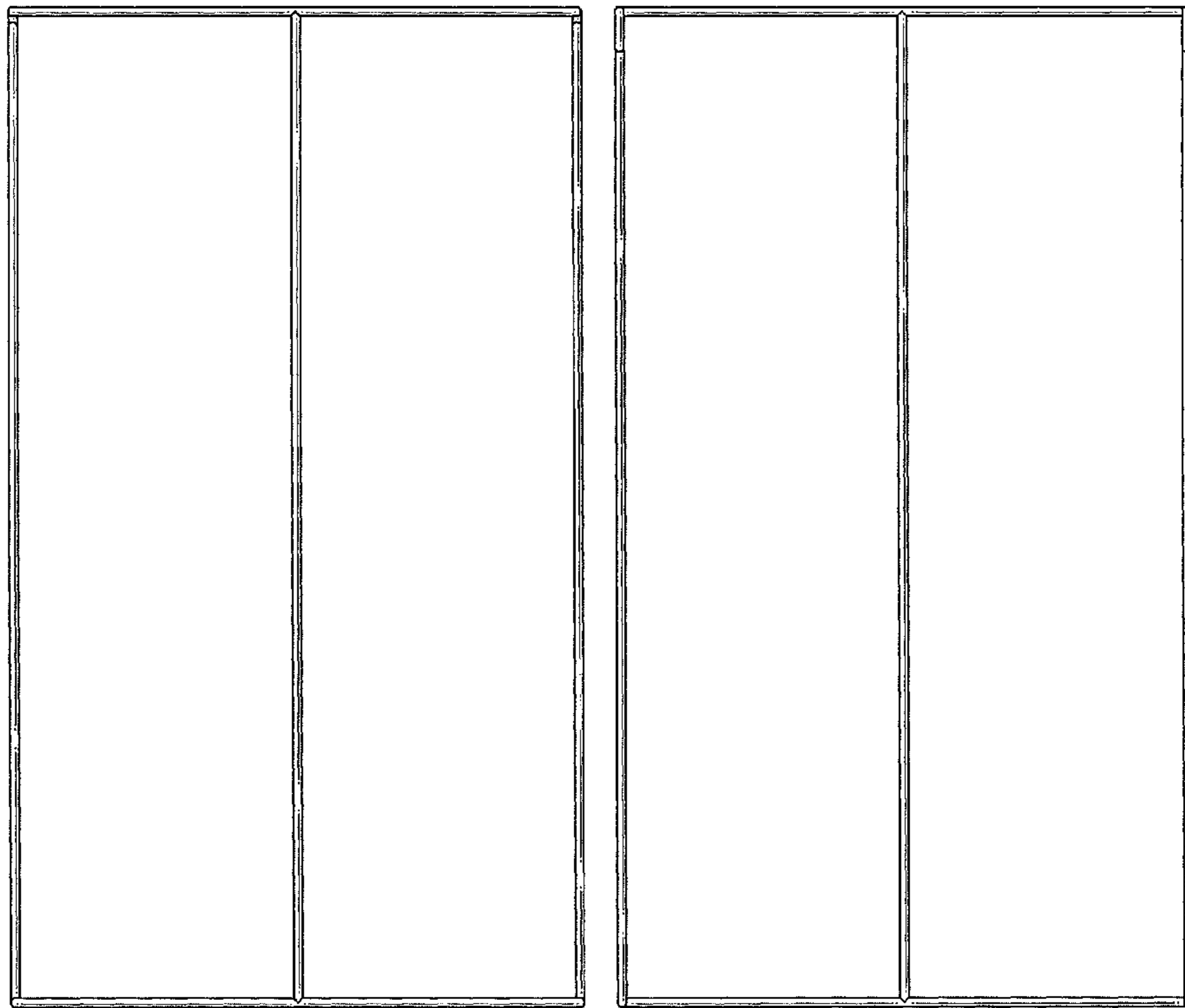

FIG. 4

FIG. 5

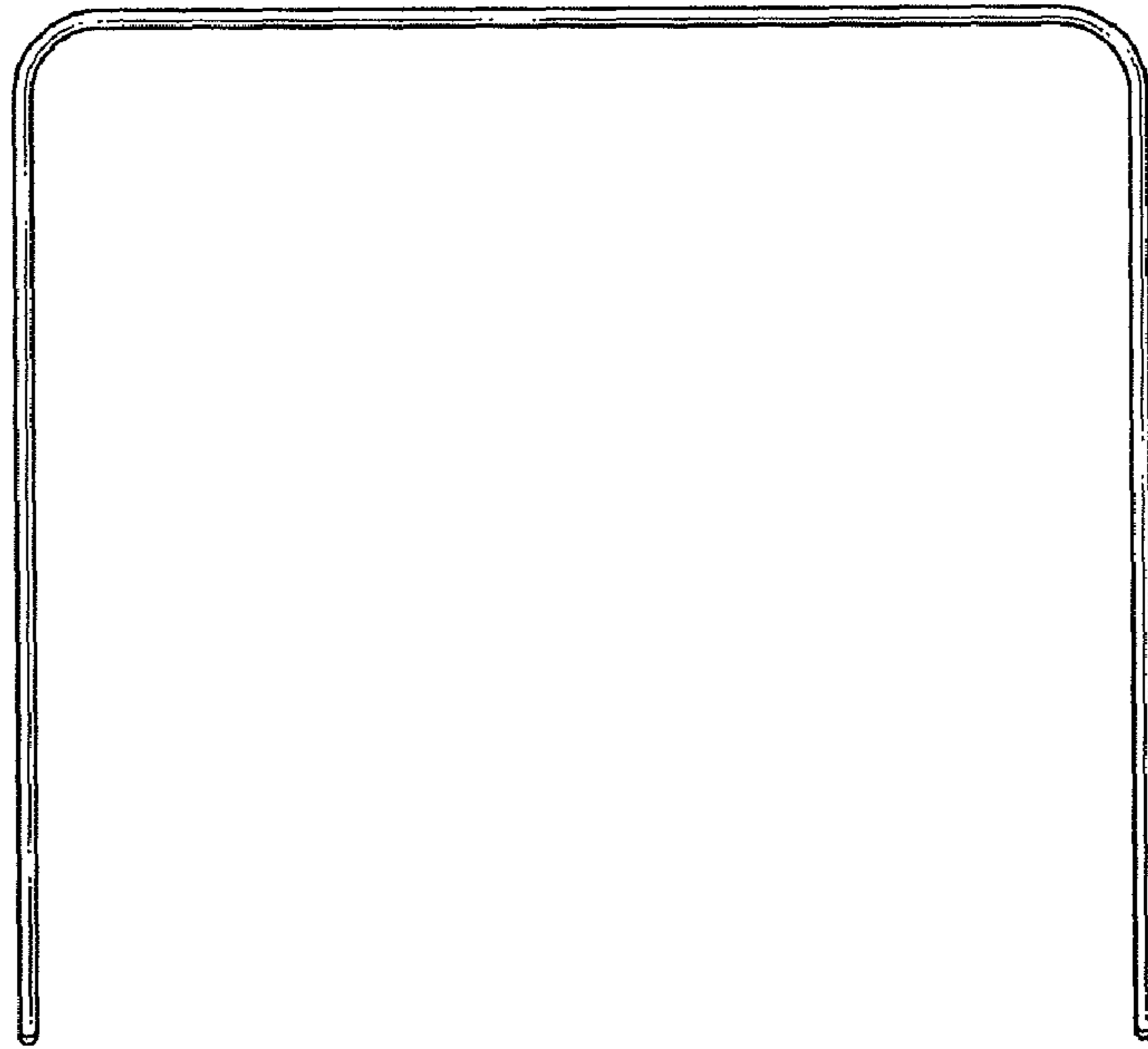

FIG. 6

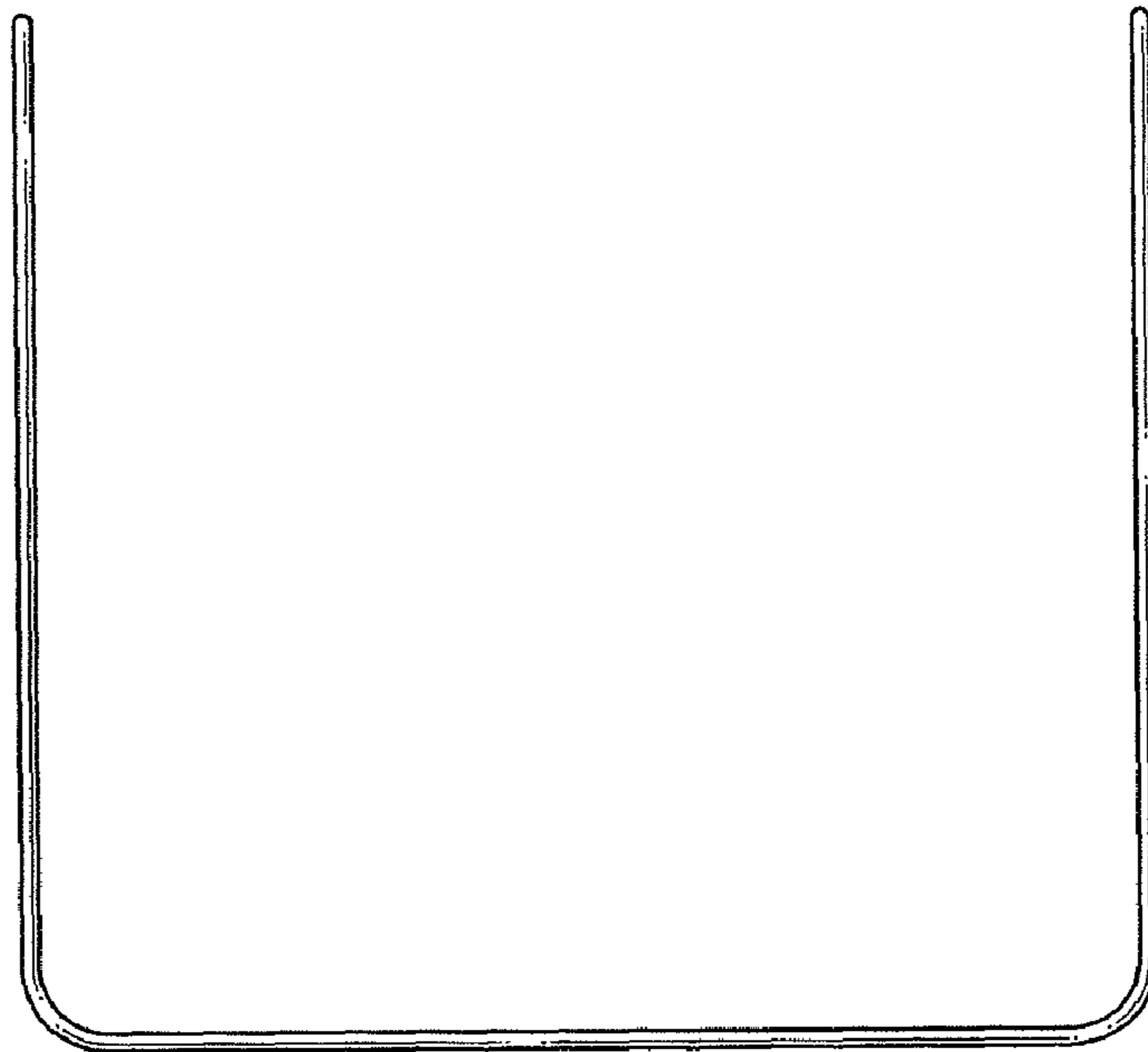

FIG. 7

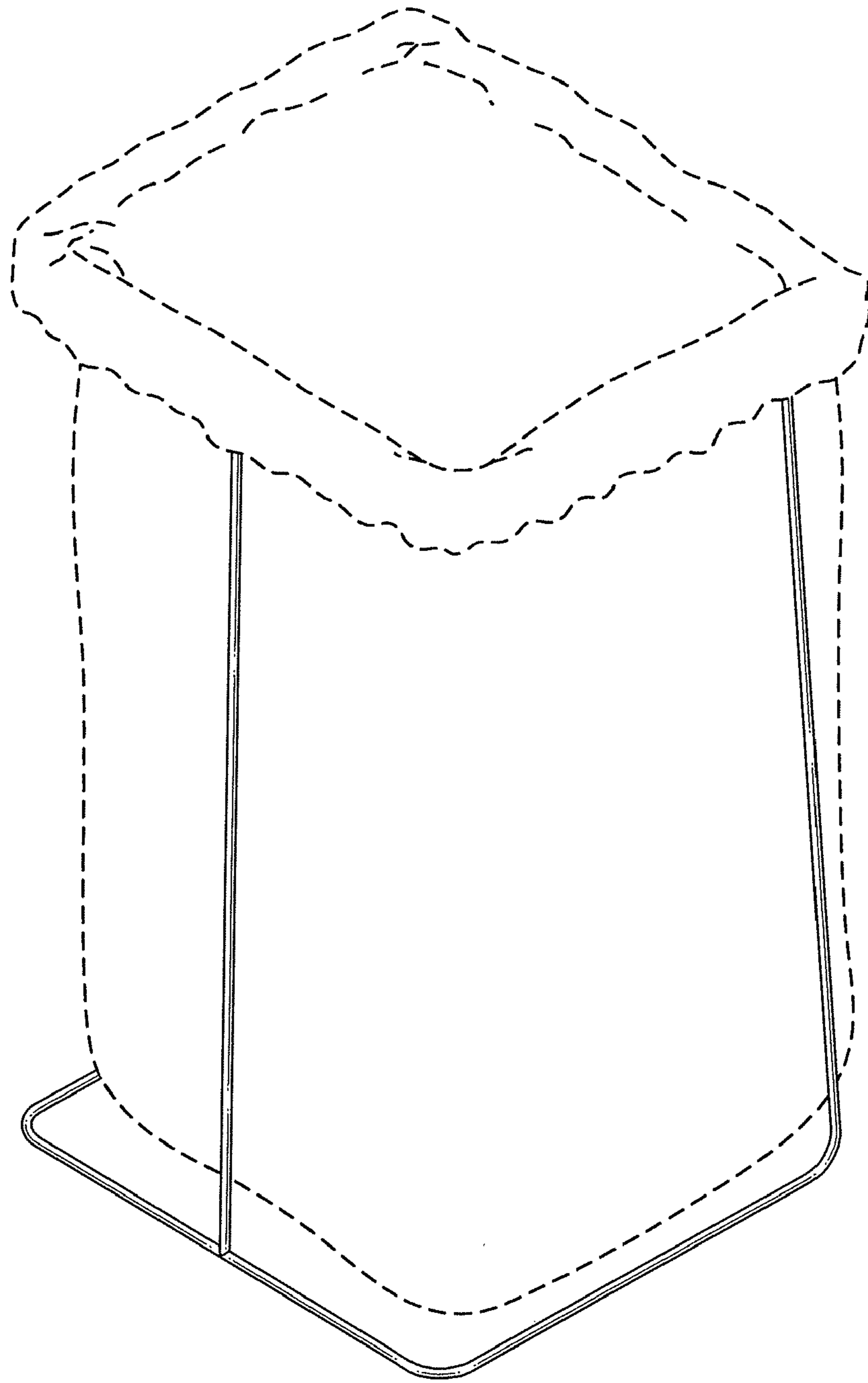

FIG. 8

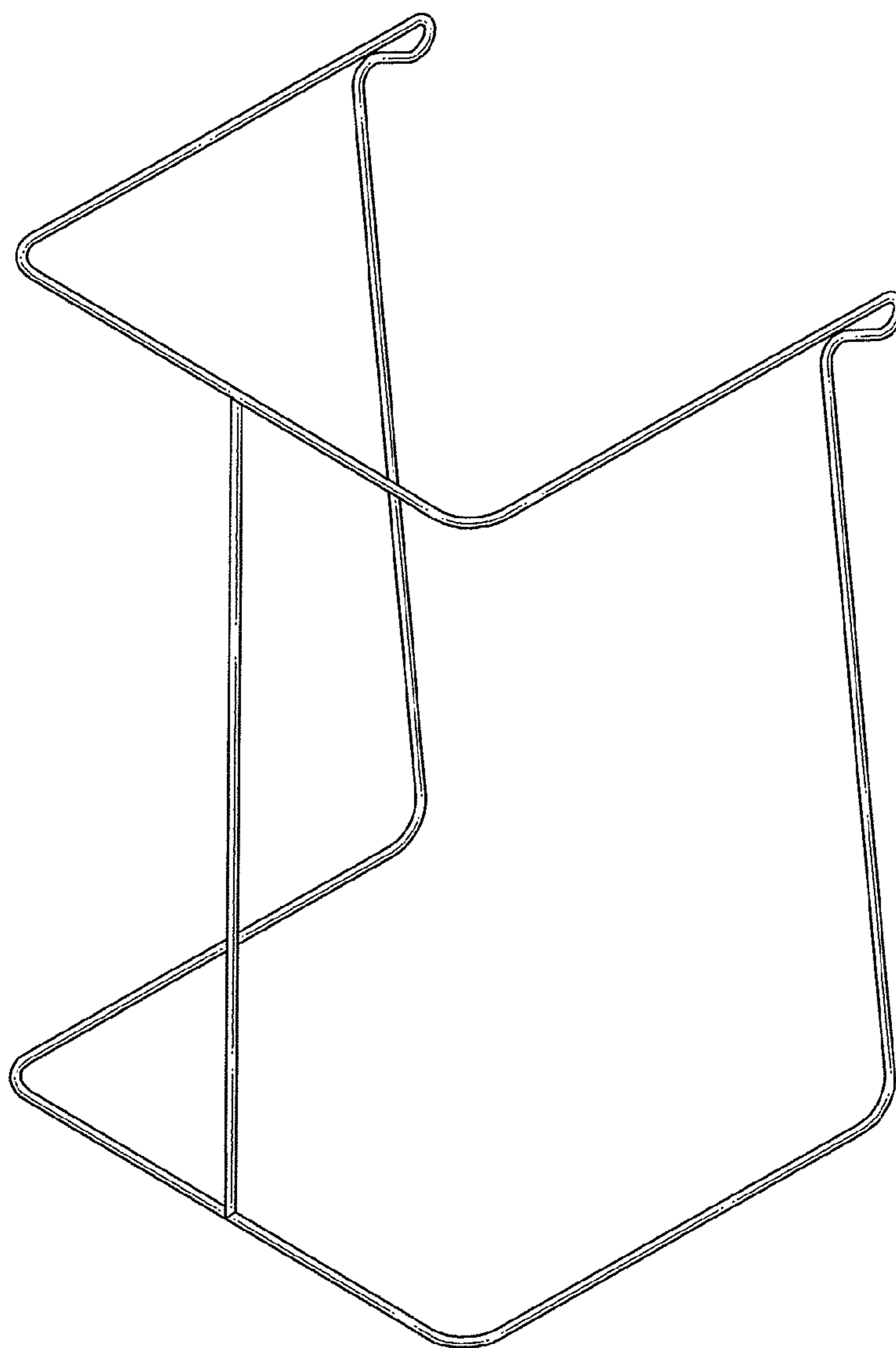

FIG. 9

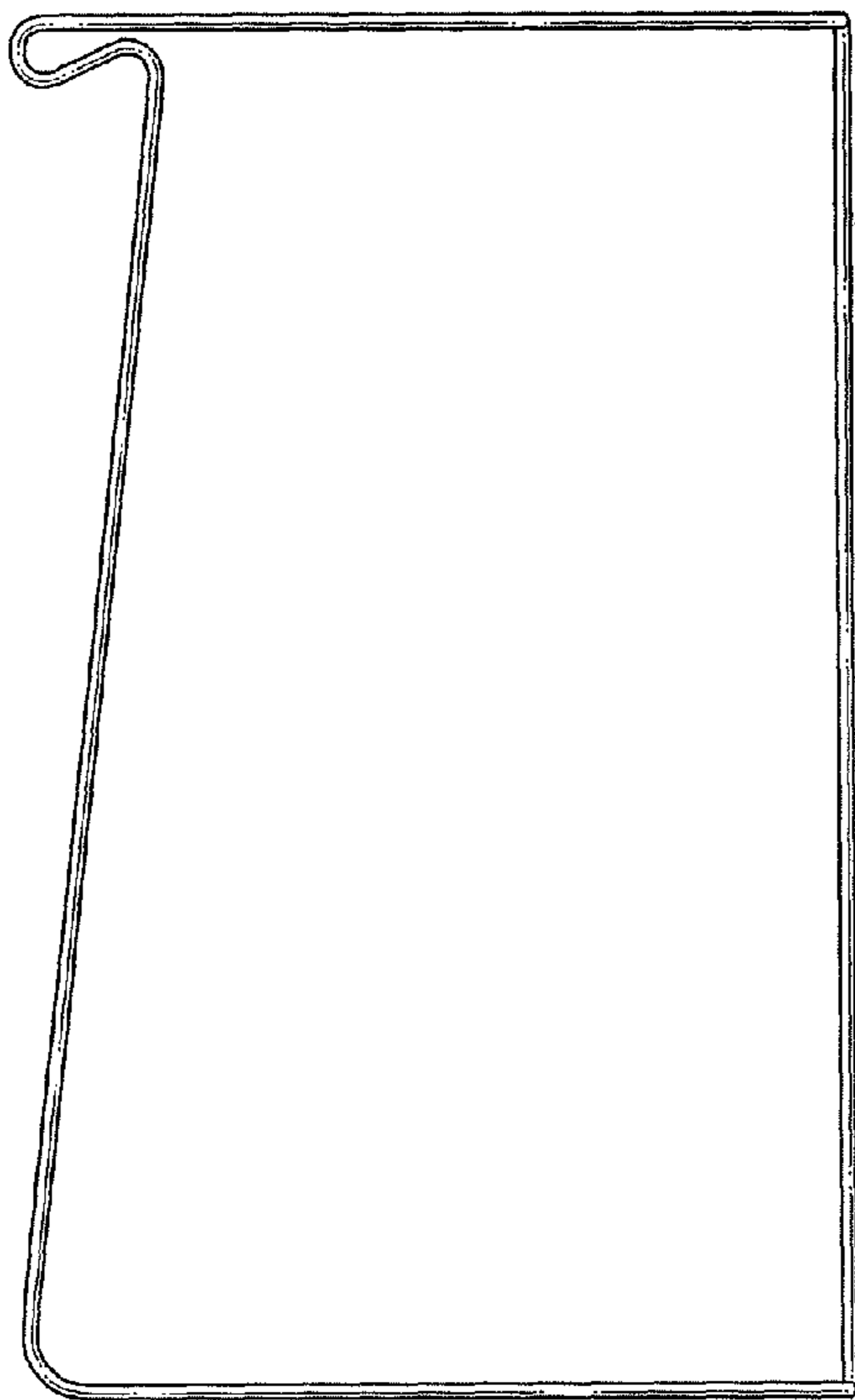

FIG. 10

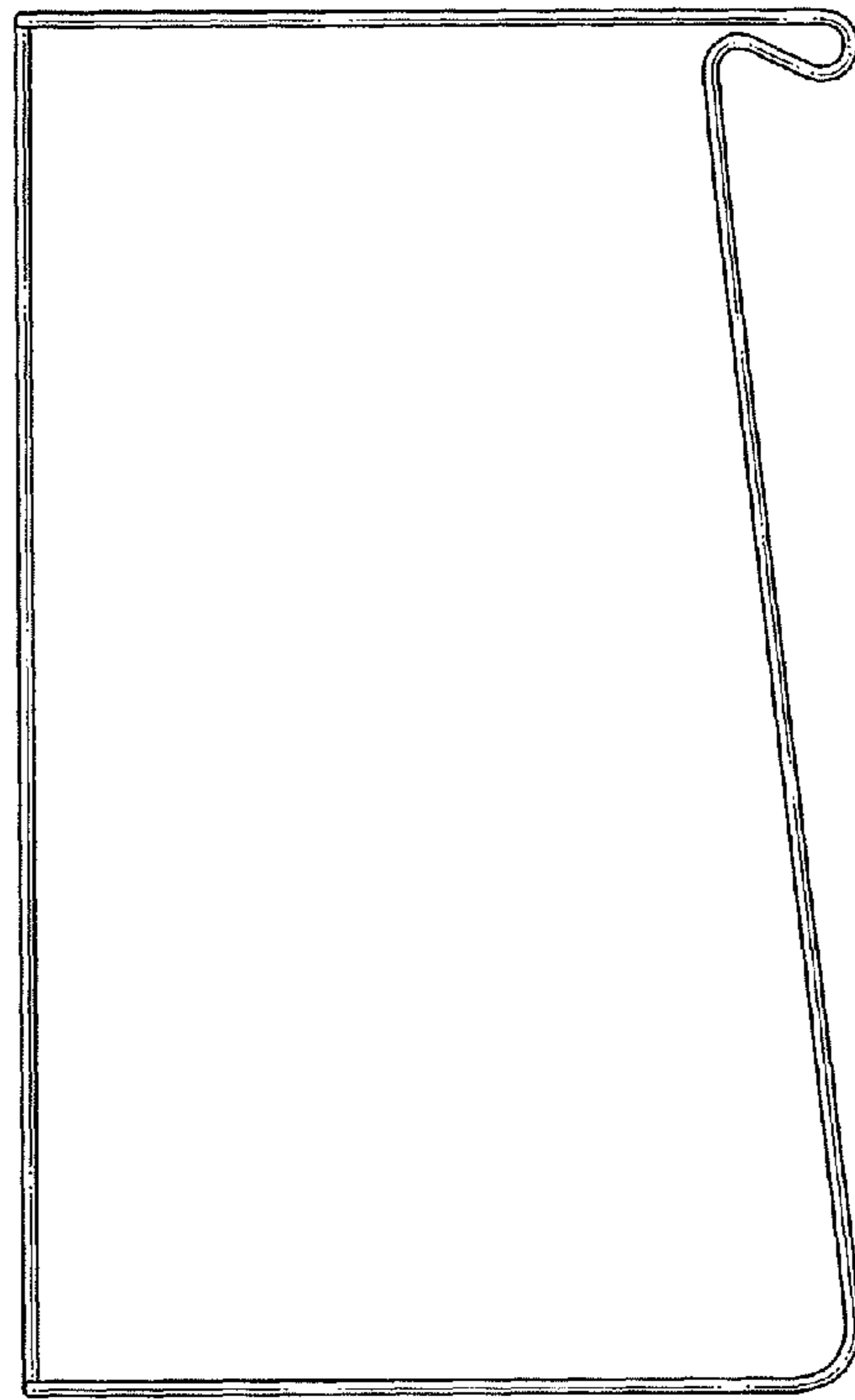

FIG. 11

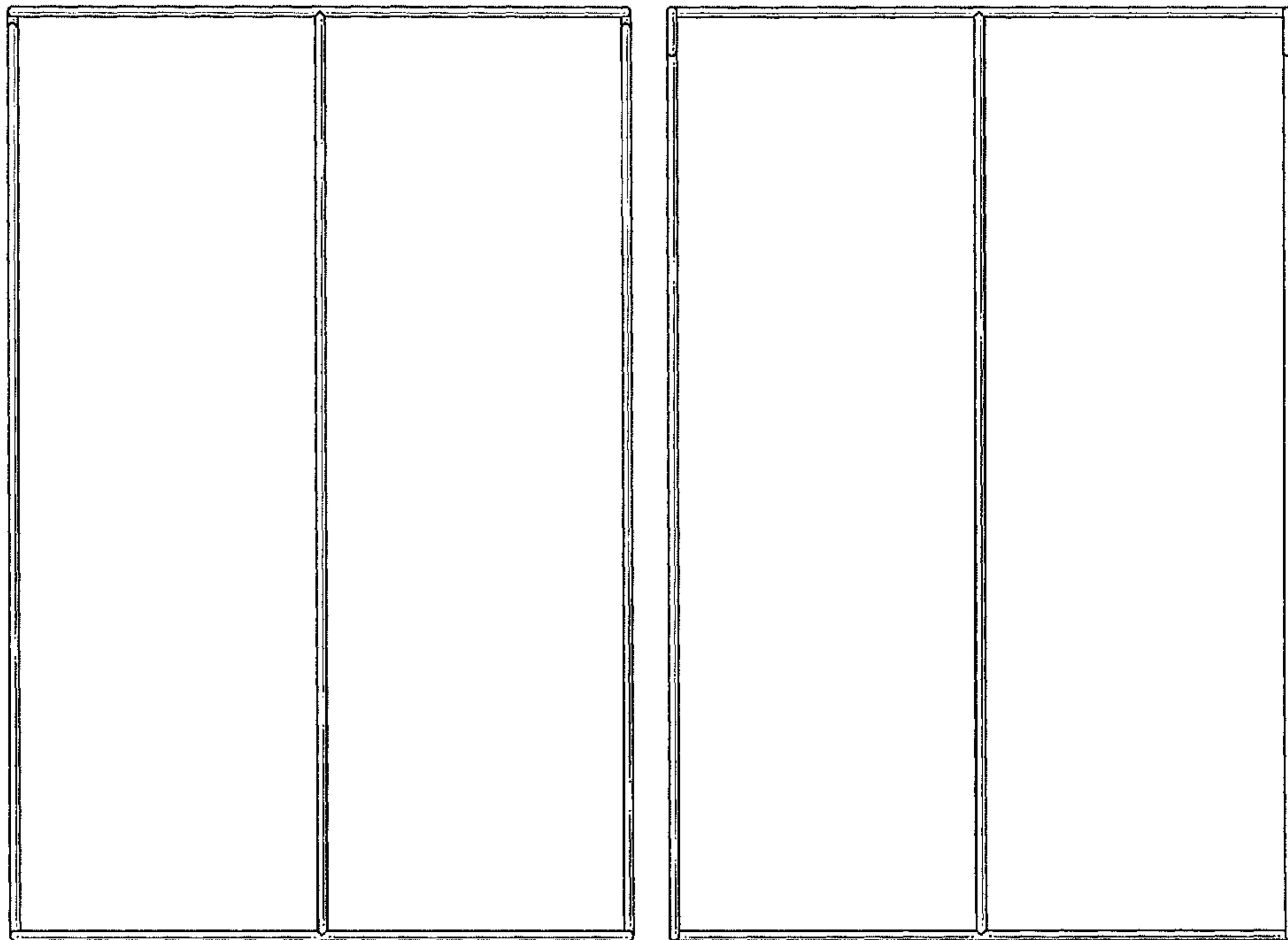

FIG. 12

FIG. 13

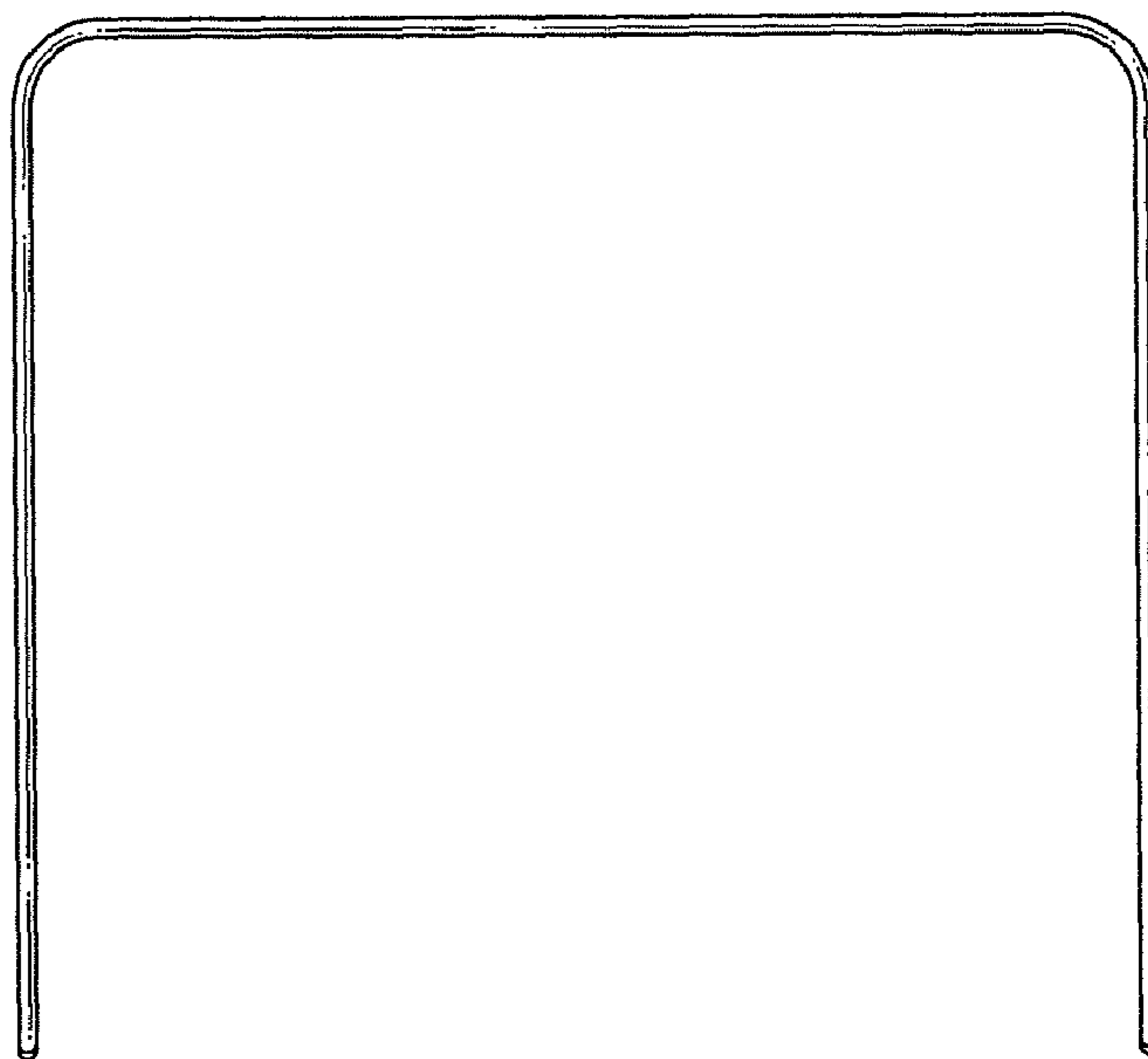

FIG. 14

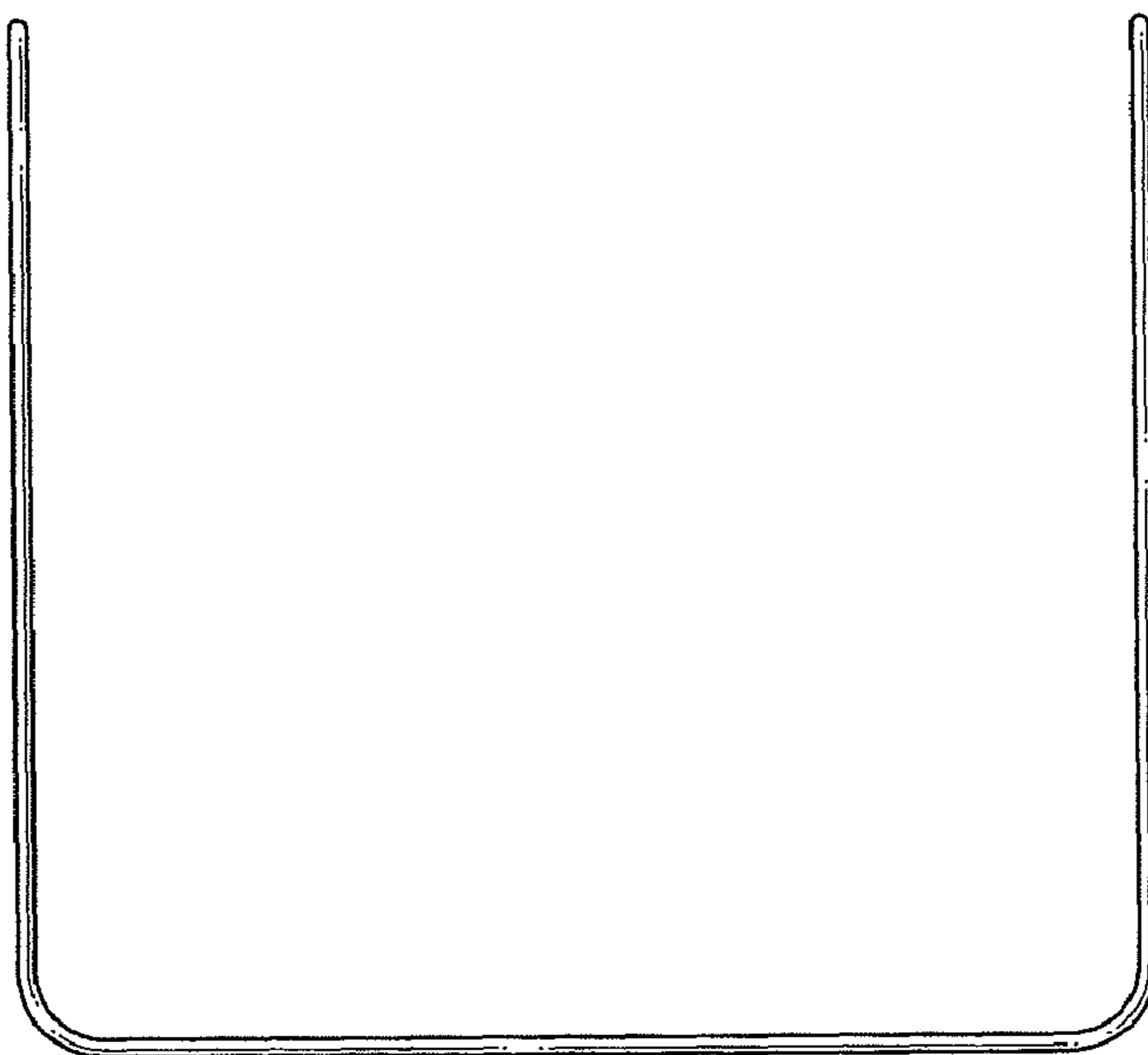

FIG. 15

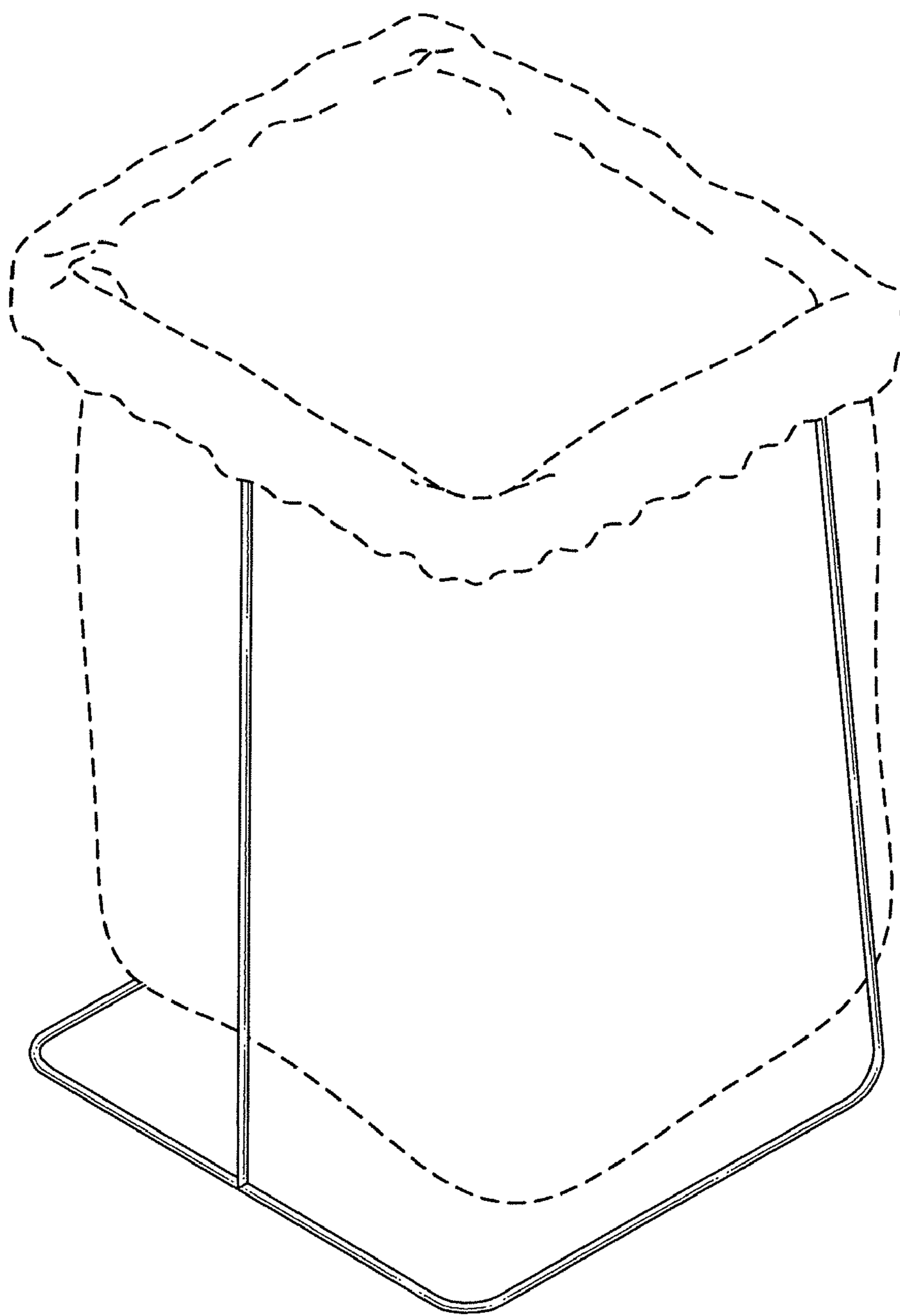

FIG. 16