

US00D665460S

(12) **United States Design Patent**
Irvine

(10) **Patent No.:** **US D665,460 S**

(45) **Date of Patent:** **** Aug. 14, 2012**

(54) **ADVERTISING SIGN**

(76) Inventor: **Scott Irvine**, Torrance, CA (US)

(**) Term: **14 Years**

(21) Appl. No.: **29/402,572**

(22) Filed: **Sep. 23, 2011**

(51) **LOC (9) Cl.** **20-03**

(52) **U.S. Cl.** **D20/29**

(58) **Field of Classification Search** D20/10,
D20/19, 22-29, 39-42, 99; 40/299.01, 446,
40/538, 541, 564, 571, 573, 584, 594, 600,
40/616; D10/109.1, 109.2, 113.4; D21/760,
D21/765, 766, 769; 362/459, 812

See application file for complete search history.

(56) **References Cited**

U.S. PATENT DOCUMENTS

D379,647 S * 6/1997 Levinthal D21/766
D408,067 S * 4/1999 McGarry D21/760
D457,587 S * 5/2002 Wolf D21/760
6,431,733 B2 * 8/2002 Seifert et al. 362/459

D498,810 S * 11/2004 Stanisewski, Jr. D21/760
D570,436 S * 6/2008 Scaturro et al. D21/769
D649,595 S * 11/2011 Marcus D20/29

* cited by examiner

Primary Examiner — Mary Ann Calabrese

(74) *Attorney, Agent, or Firm* — QuickPatents, Inc.; Kevin Prince

(57) **CLAIM**

I claim the ornamental design for an advertising sign, as shown and described.

DESCRIPTION

FIG. 1 is a front perspective view of an advertising sign, showing my new design;
FIG. 2 is a rear perspective view thereof;
FIG. 3 is a top plan view thereof;
FIG. 4 is a bottom plan view thereof;
FIG. 5 is a left-side elevational view thereof;
FIG. 6 is a right-side elevational view thereof;
FIG. 7 is a front elevational view thereof; and,
FIG. 8 is a rear elevational view thereof.

The broken lines showing indicia on the front side of the design depict environmental matter and form no part of the claimed design.

1 Claim, 3 Drawing Sheets

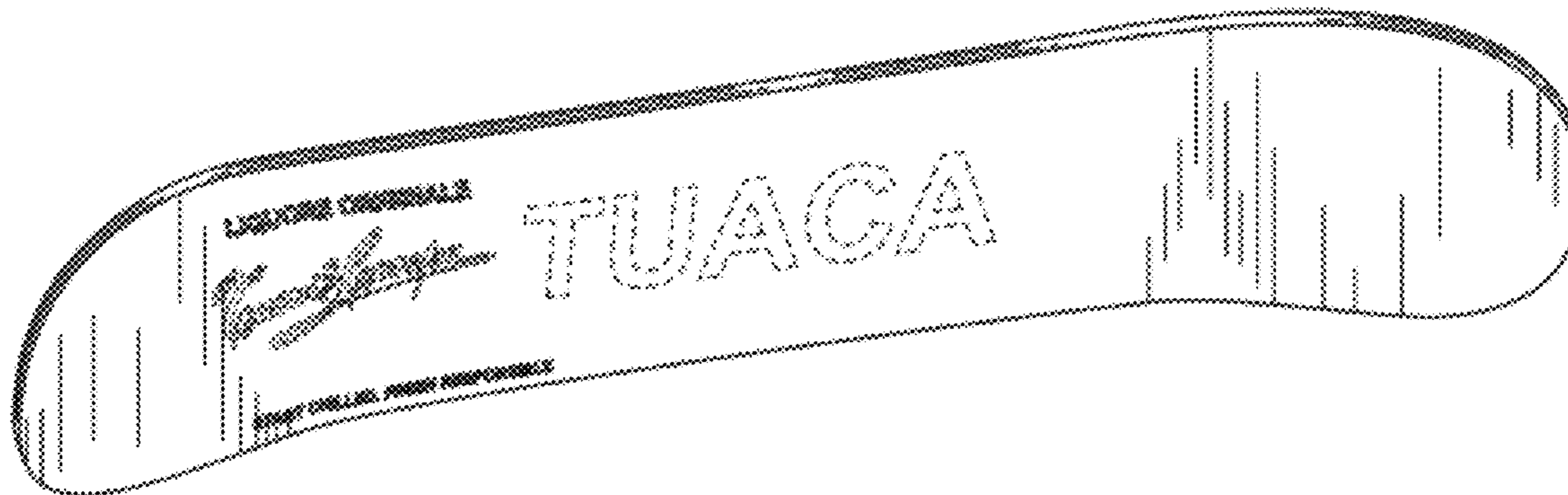

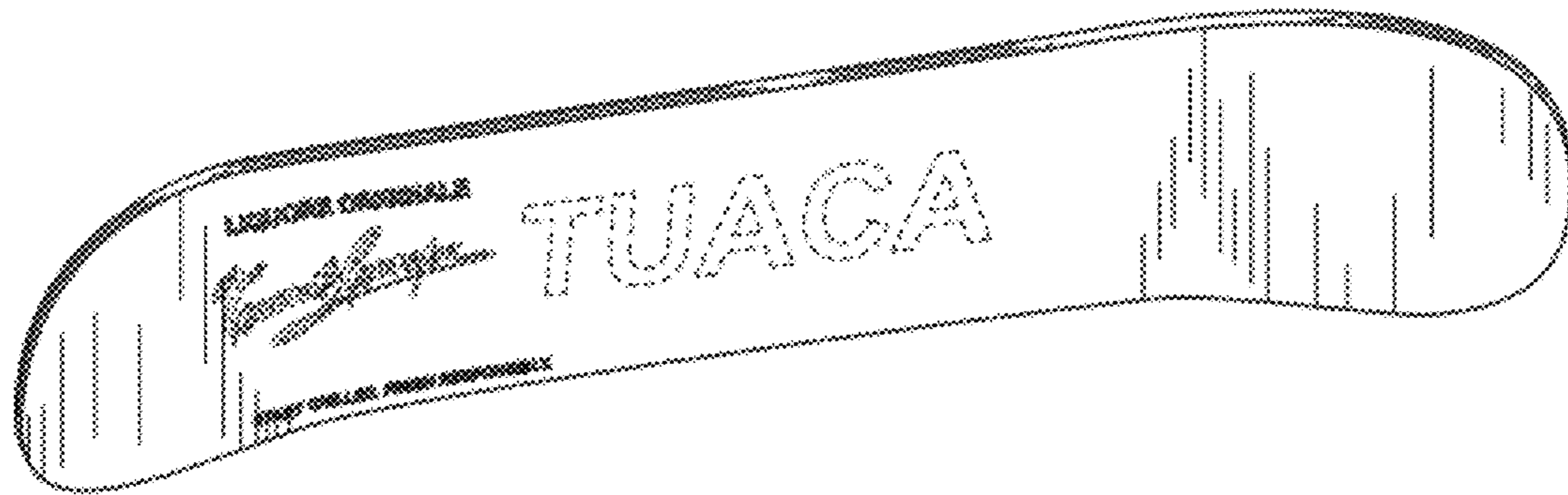

FIG. 1

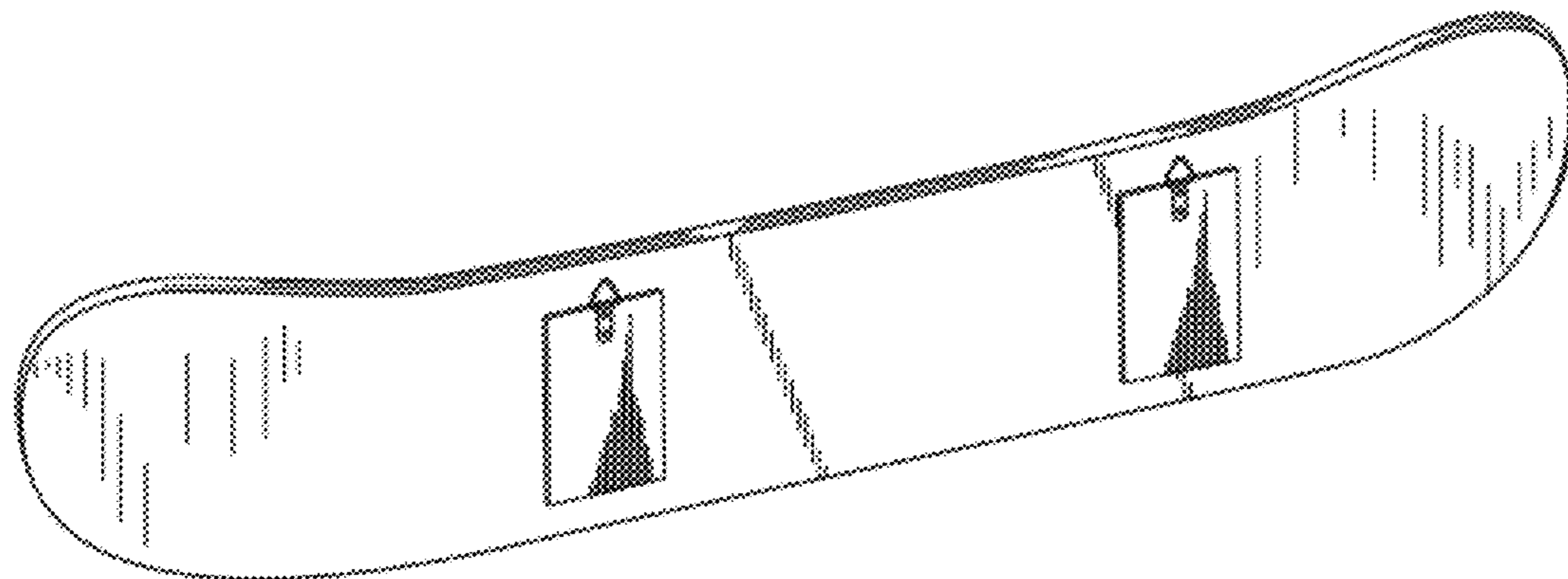

FIG. 2

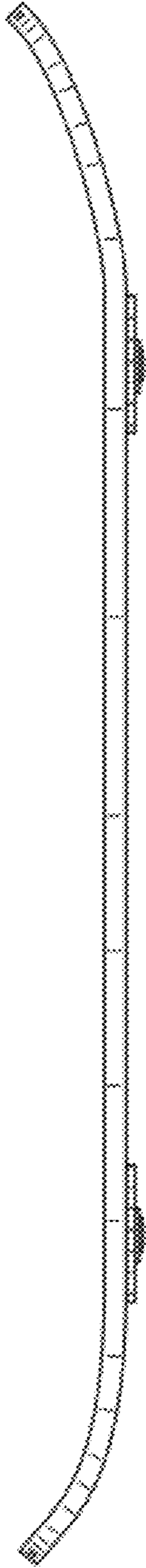

FIG. 3

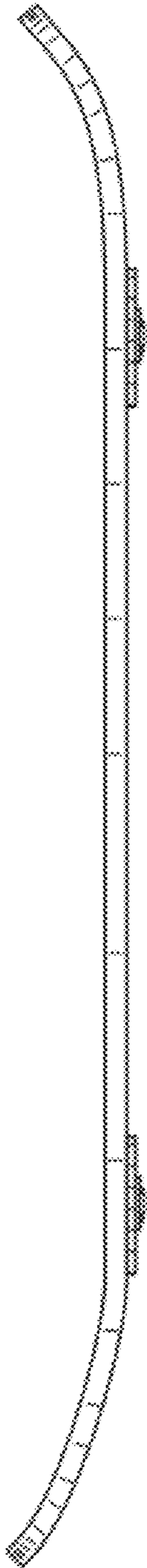

FIG. 4

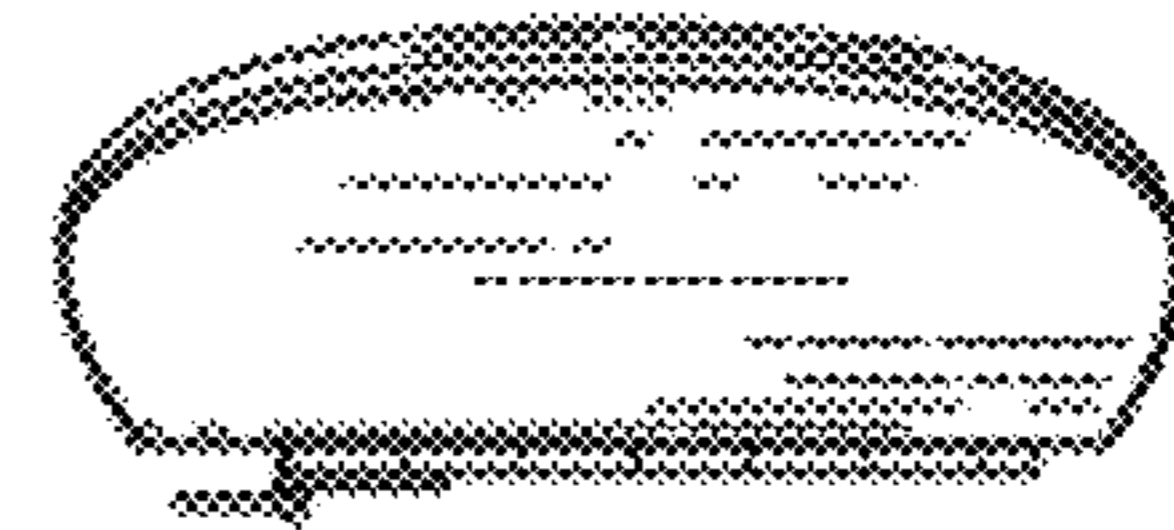

FIG. 5

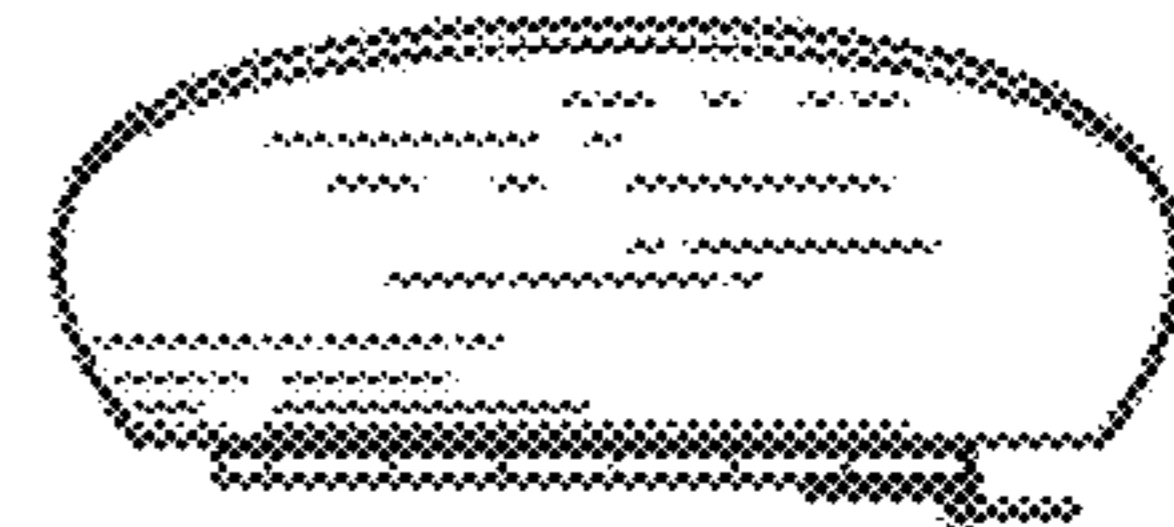

FIG. 6

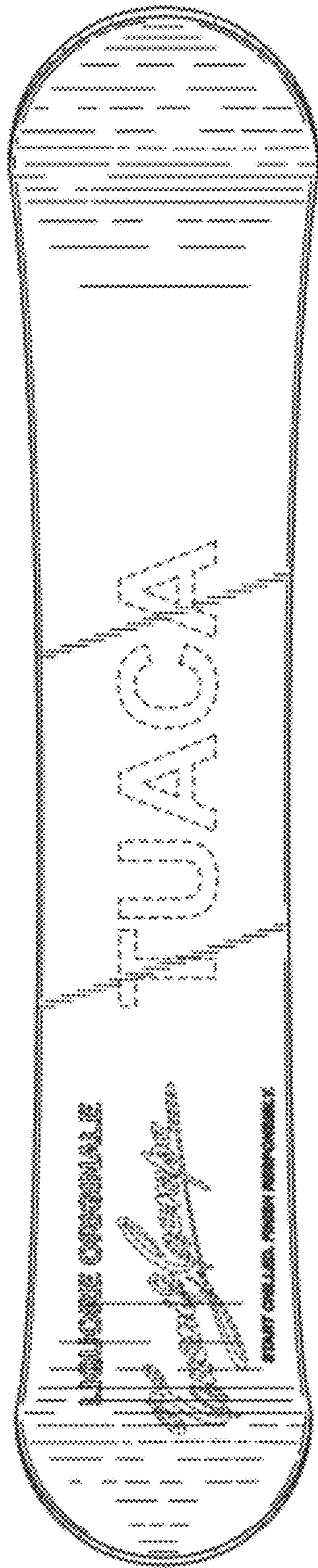

FIG. 7

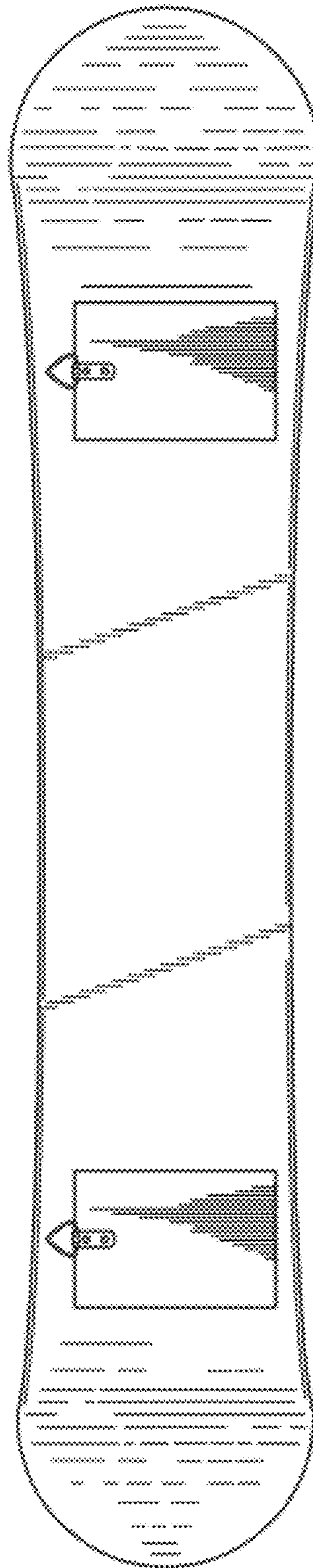

FIG. 8