



US00D665453S

(12) **United States Design Patent**
Dambricourt

(10) **Patent No.:** **US D665,453 S**
(45) **Date of Patent:** **** Aug. 14, 2012**

- (54) **LETTER TRAY**
 - (75) Inventor: **Géry Dambricourt**, Escoutoux (FR)
 - (73) Assignee: **CEP Office Solutions** (FR)
 - (**) Term: **14 Years**
 - (21) Appl. No.: **29/388,994**
 - (22) Filed: **Apr. 5, 2011**
 - (30) **Foreign Application Priority Data**
 - Oct. 5, 2010 (EM) 001237911
 - (51) **LOC (9) Cl.** **19-02**
 - (52) **U.S. Cl.** **D19/92**
 - (58) **Field of Classification Search** D3/304,
 - D3/310, 313, 314, 315; D6/475, 510; D7/554.3;
 - D19/75, 77-92, 99, 100; 206/215, 449, 558;
 - 211/126.1
- See application file for complete search history.

4,863,042	A *	9/1989	Rohner	211/11
4,887,724	A *	12/1989	Pielechowski et al.	211/11
D316,116	S *	4/1991	Hawes et al.	D19/92
5,054,629	A *	10/1991	Breen	211/126.12
D325,222	S *	4/1992	Brussing	D19/92
D334,774	S *	4/1993	Prey	D19/92
5,299,690	A *	4/1994	Mund et al.	206/503
D368,116	S *	3/1996	Kozo	D19/92
D377,128	S *	1/1997	Baker	D6/479
D425,937	S *	5/2000	Serrault et al.	D19/92
D428,059	S *	7/2000	Saylor et al.	D19/92
6,189,705	B1 *	2/2001	Saylor et al.	211/11
D455,786	S *	4/2002	Walz	D19/92
D461,995	S *	8/2002	Massaloux et al.	D7/554.3
D497,781	S *	11/2004	Joseph	D7/641
D522,061	S *	5/2006	Chen et al.	D19/92
D544,037	S *	6/2007	Bonaventura	D19/92

(Continued)

Primary Examiner — Elizabeth Albert
(74) *Attorney, Agent, or Firm* — Banner & Witcoff, Ltd.

(56) **References Cited**

U.S. PATENT DOCUMENTS

1,740,424	A *	12/1929	Blaine	206/449
2,100,720	A *	11/1937	Page	206/449
2,276,121	A *	3/1942	Thorn et al.	211/133.3
D144,450	S *	4/1946	Cohen	D19/92
2,704,974	A *	3/1955	Steman	99/422
D179,276	S *	11/1956	Abrahamson	D19/92
D179,534	S *	1/1957	Bullock et al.	D19/92
3,003,647	A *	10/1961	Lockwood	211/126.8
D207,851	S *	6/1967	Separa	D6/449
3,480,154	A *	11/1969	Telfer	211/126.5
3,482,708	A *	12/1969	Levit et al.	211/126.12
3,648,849	A *	3/1972	Harris et al.	211/126.12
D231,496	S *	4/1974	Saltz	D19/92
D232,934	S *	9/1974	Perry	D19/92
3,968,881	A *	7/1976	Beil et al.	211/126.12
D240,820	S *	8/1976	Beil	D19/92
4,074,810	A *	2/1978	Juergens et al.	211/11
D251,251	S *	3/1979	Tiedemann	D19/20
D257,858	S *	1/1981	Sklaroff	D19/92
D260,907	S *	9/1981	Giulie et al.	D19/92
D261,904	S *	11/1981	Polhemus	D19/92
D270,356	S *	8/1983	Beltrami	D19/86
4,534,475	A *	8/1985	Mayo	211/126.12
D285,218	S *	8/1986	Mayo	D19/92
4,657,148	A *	4/1987	Heng	211/126.12
4,768,655	A *	9/1988	MacGregor	211/11

(57) **CLAIM**
The ornamental design for a letter tray, as shown and described.

DESCRIPTION

FIG. 1 is a perspective view of a letter tray showing my new design;
 FIG. 2 is a front elevational view thereof;
 FIG. 3 is a rear elevational view thereof;
 FIG. 4 is a right side elevational view thereof;
 FIG. 5 is a left side elevational view thereof;
 FIG. 6 is a top plan view thereof;
 FIG. 7 is a bottom plan view thereof;
 FIG. 8 is a perspective view of the letter tray of FIGS. 1-7 with the lines visible through the translucent surfaces being removed for clarity;
 FIG. 9 is a front elevational view thereof;
 FIG. 10 is a rear elevational view thereof;
 FIG. 11 is a right side elevational view thereof;
 FIG. 12 is a left side elevational view thereof;
 FIG. 13 is a top plan view thereof; and,
 FIG. 14 is a bottom plan view thereof.

1 Claim, 10 Drawing Sheets

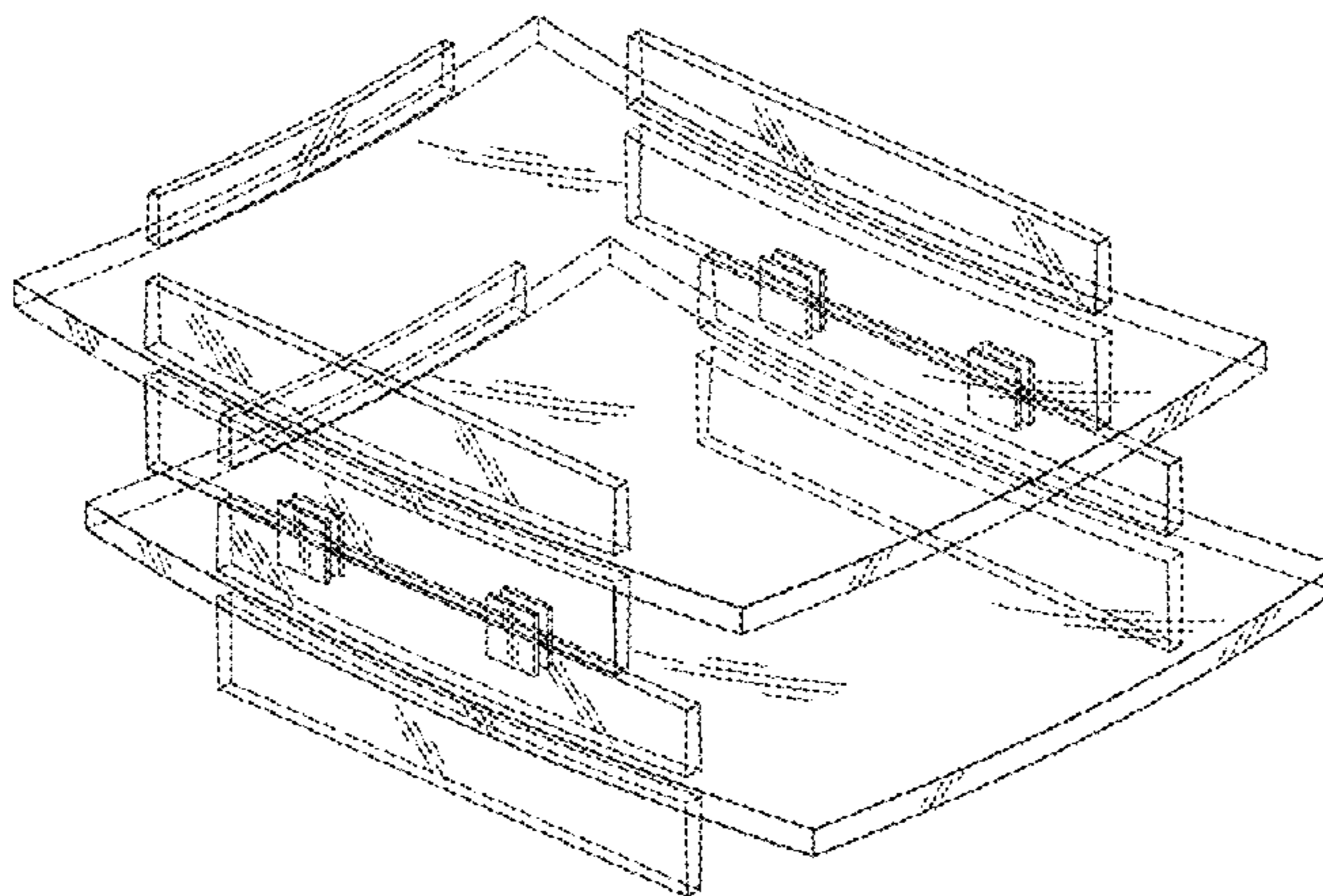

US D665,453 S

Page 2

U.S. PATENT DOCUMENTS

D553,688 S *	10/2007	Bonaventura	D19/92	D642,829 S *	8/2011	Spindelbalker	D6/491
D555,204 S *	11/2007	Smith et al.	D19/92	2004/0084387 A1 *	5/2004	Chang	211/11
D571,408 S *	6/2008	Smith et al.	D19/92	2004/0129655 A1 *	7/2004	Balzarini et al.	211/11
D641,210 S *	7/2011	Hamilton	D7/554.3				

* cited by examiner

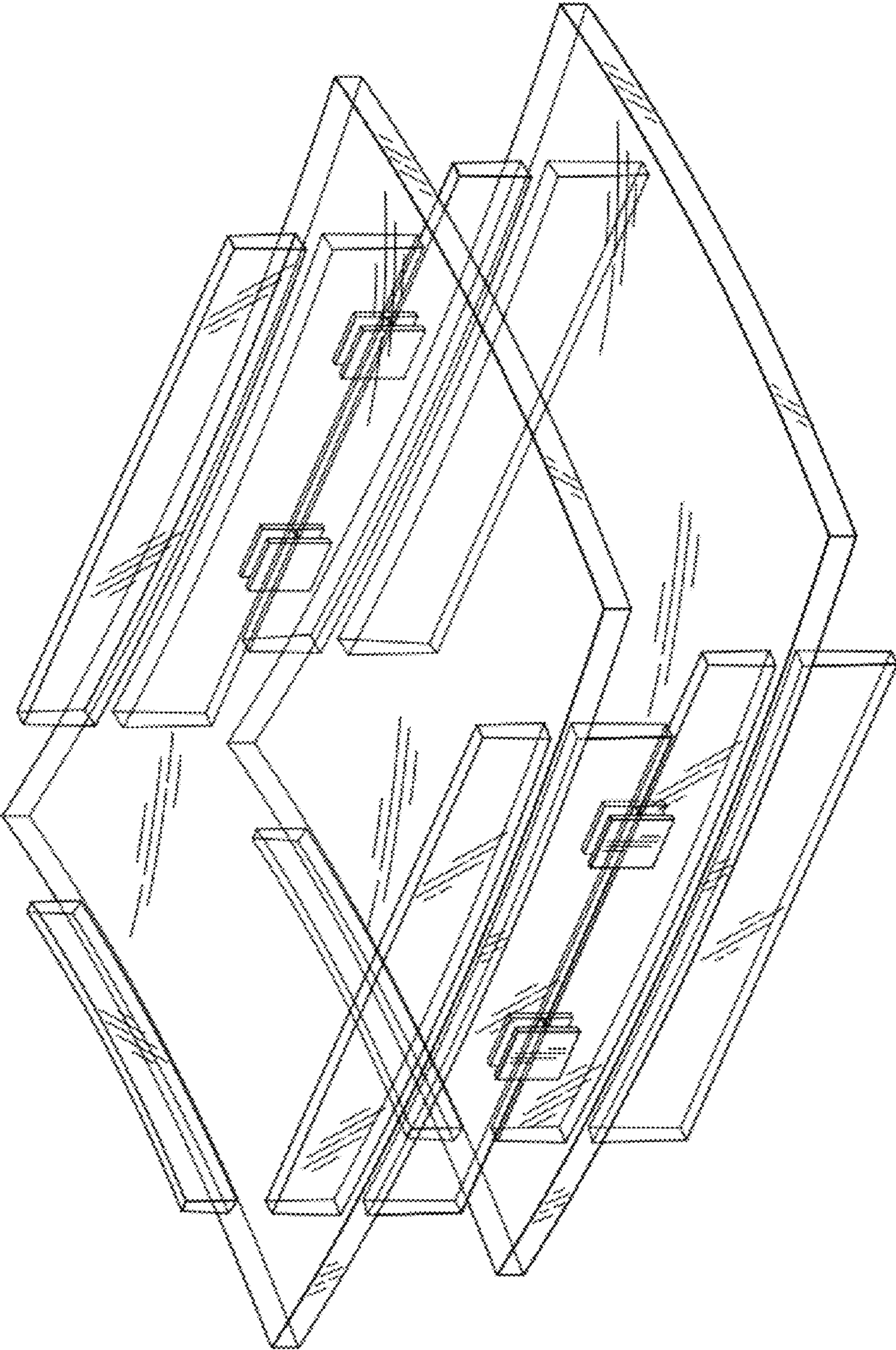

FIG. 1

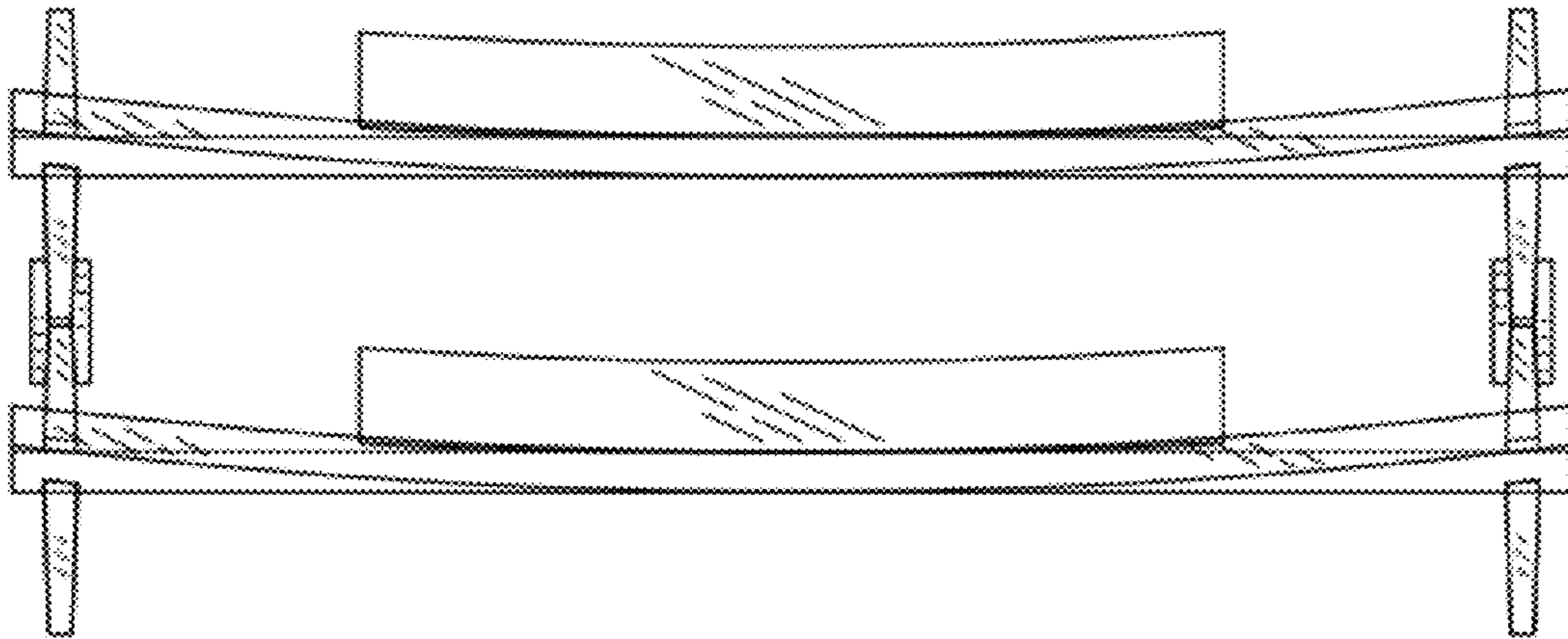

FIG. 2

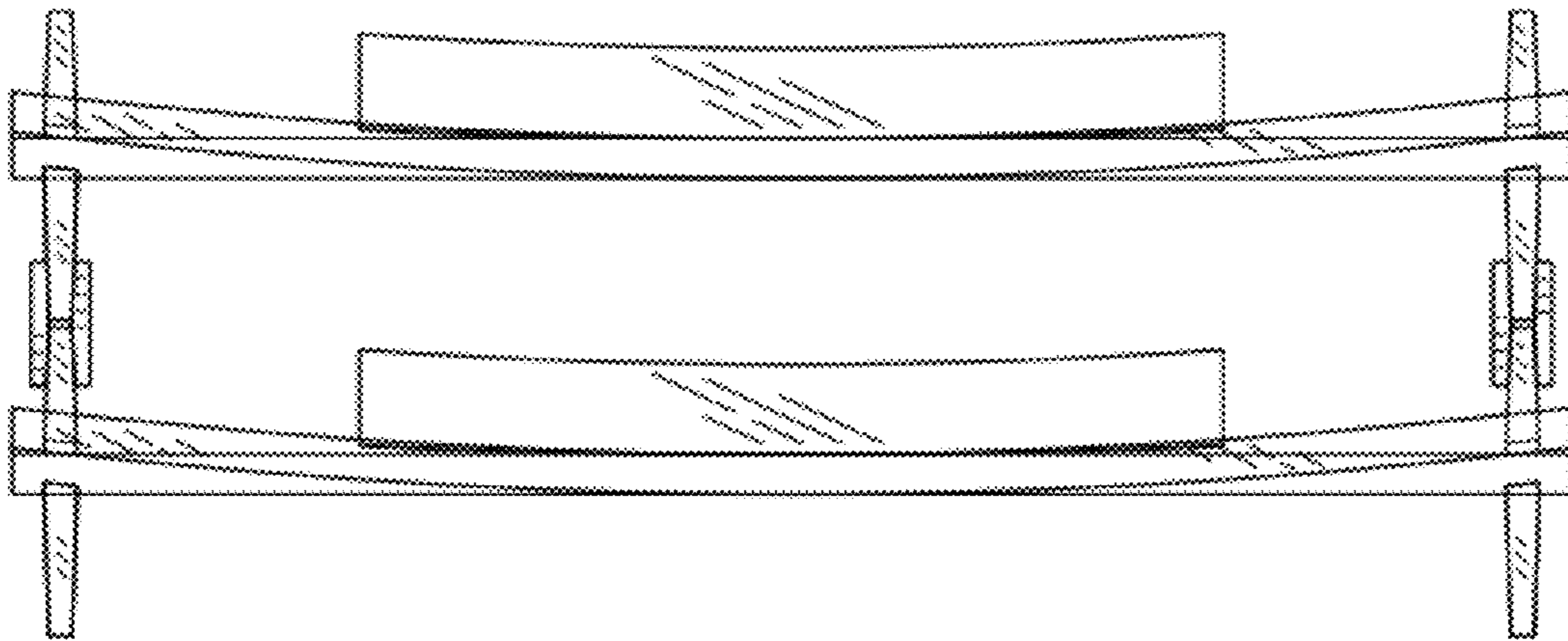

FIG. 3

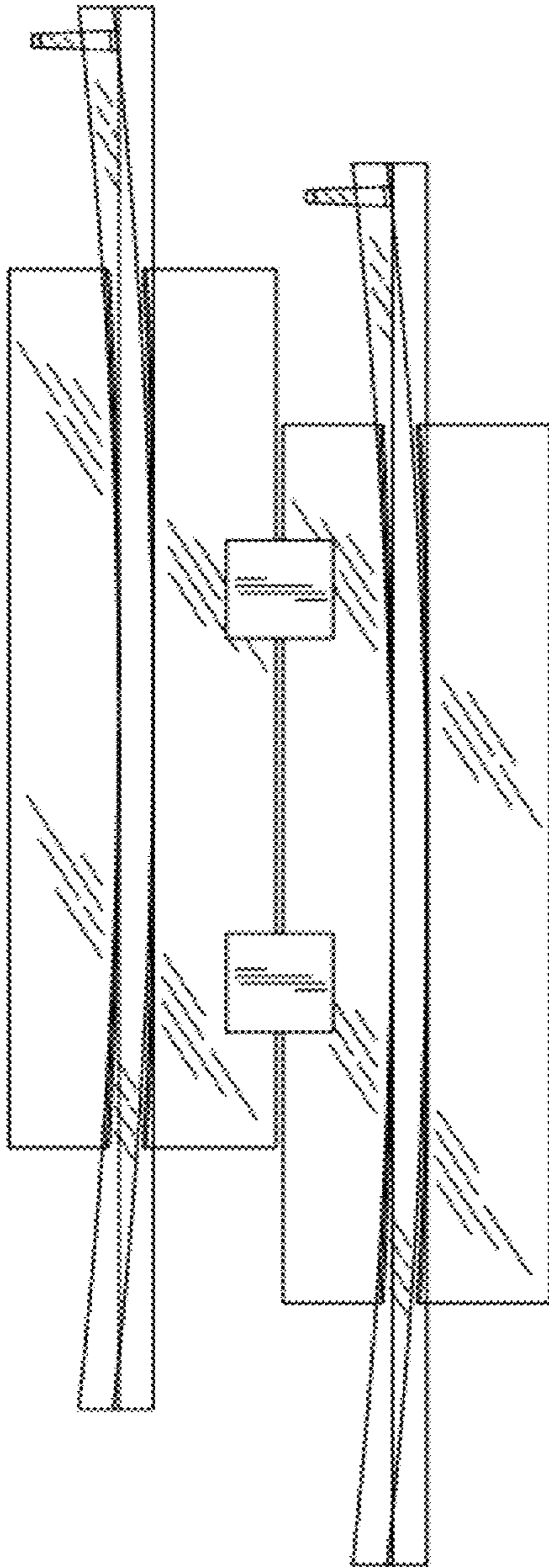

FIG. 4

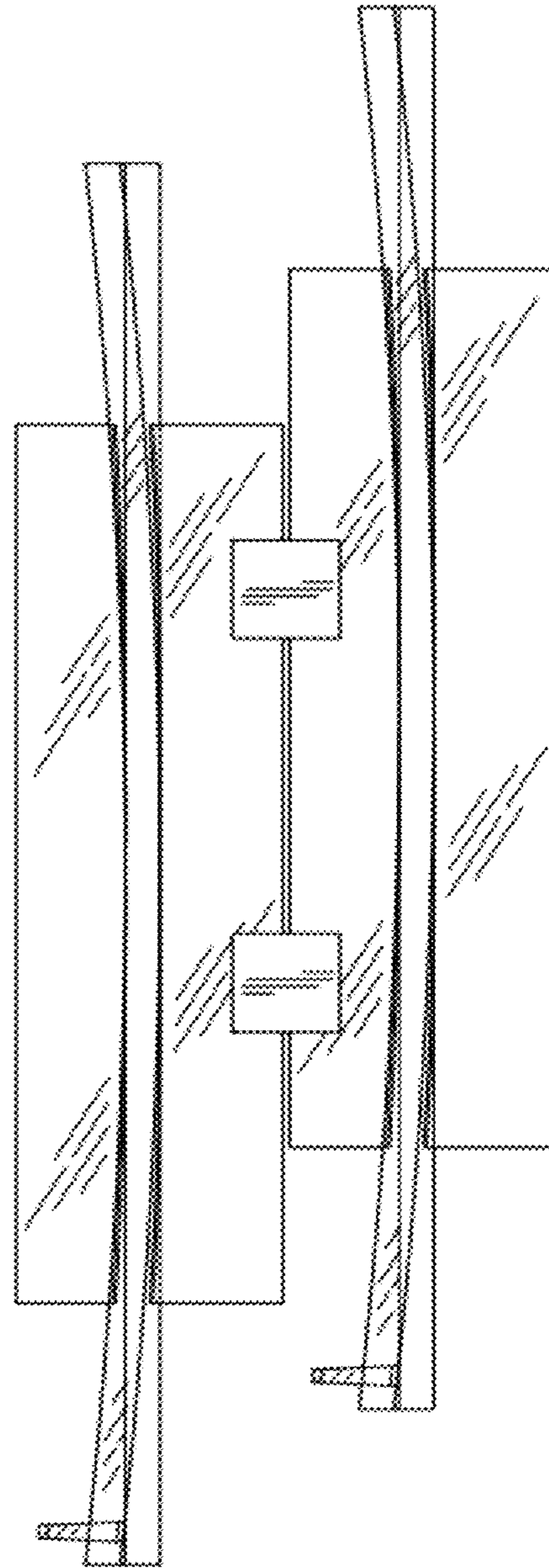

FIG. 5

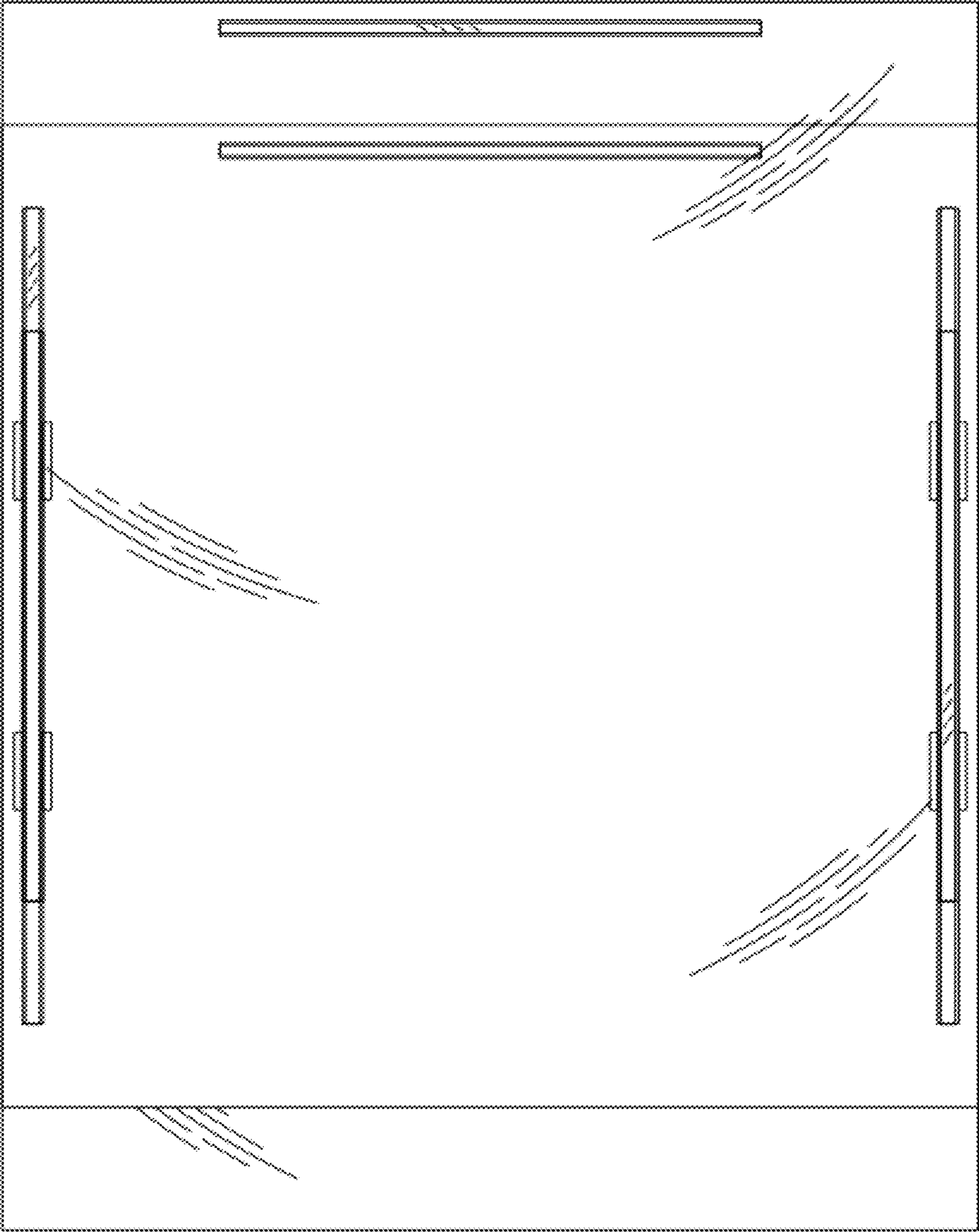

FIG. 6

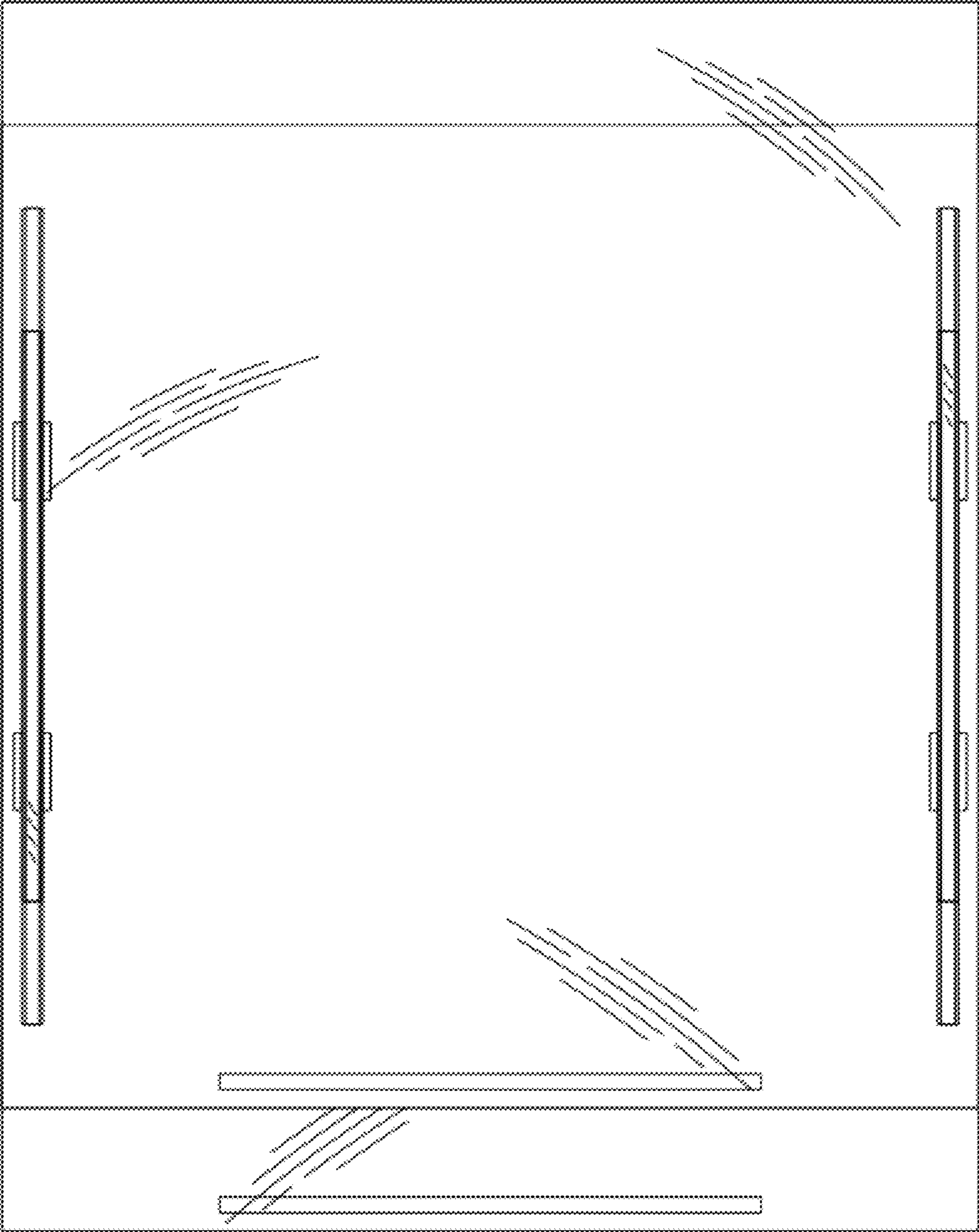

FIG. 7

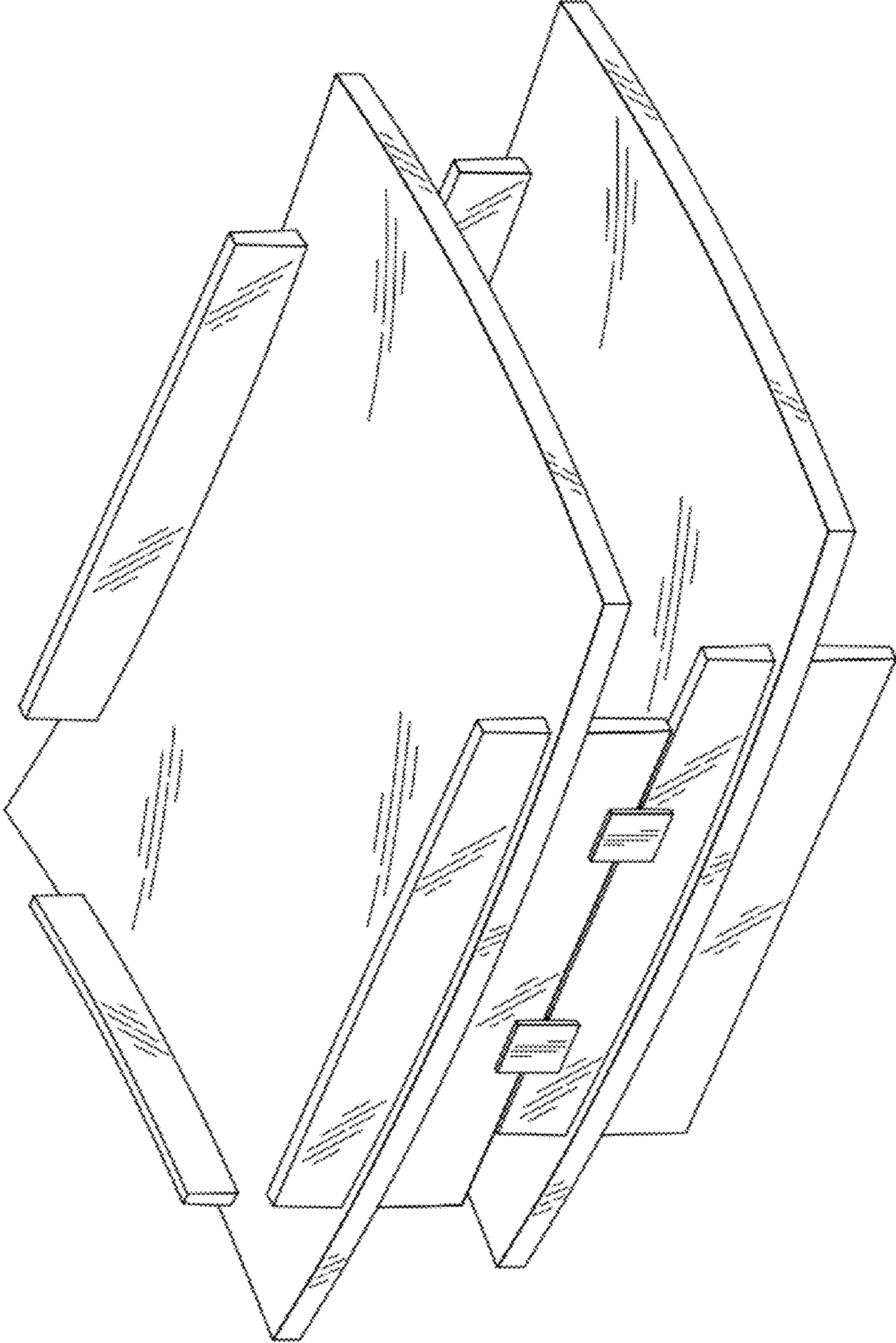

FIG. 8

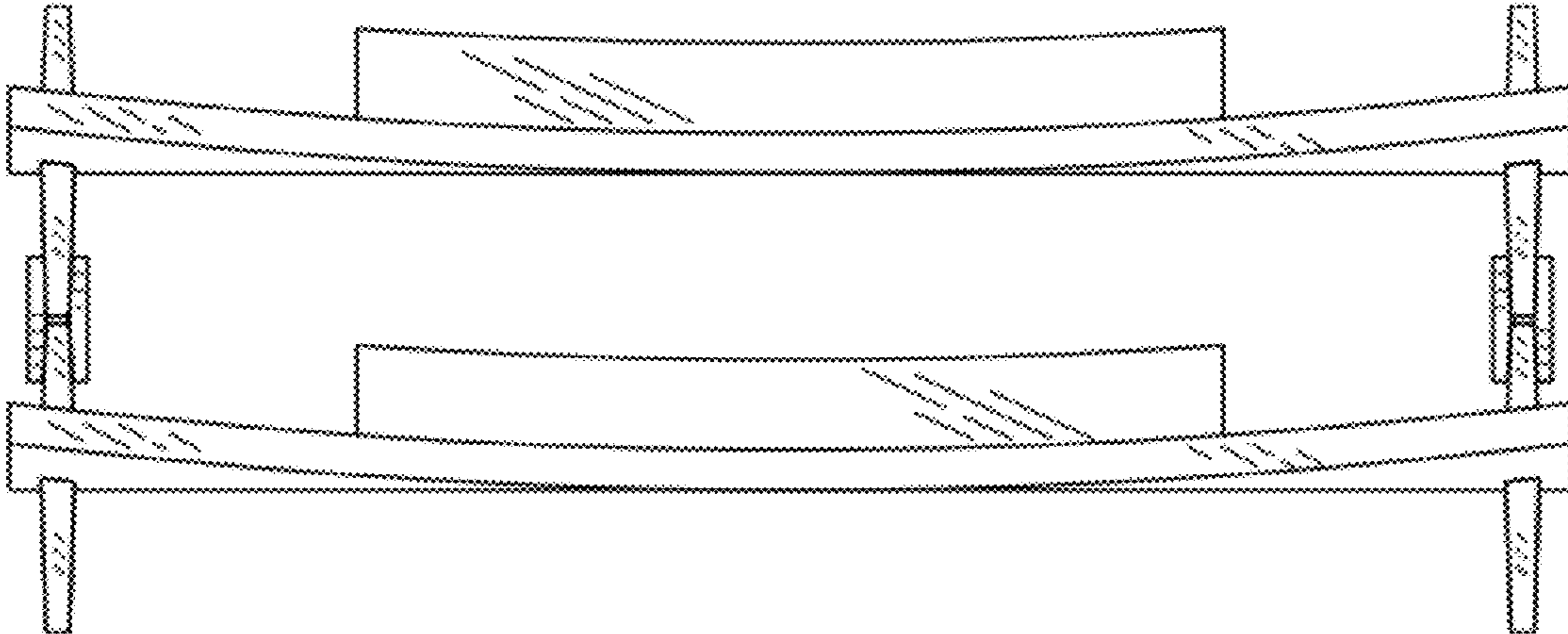

FIG. 9

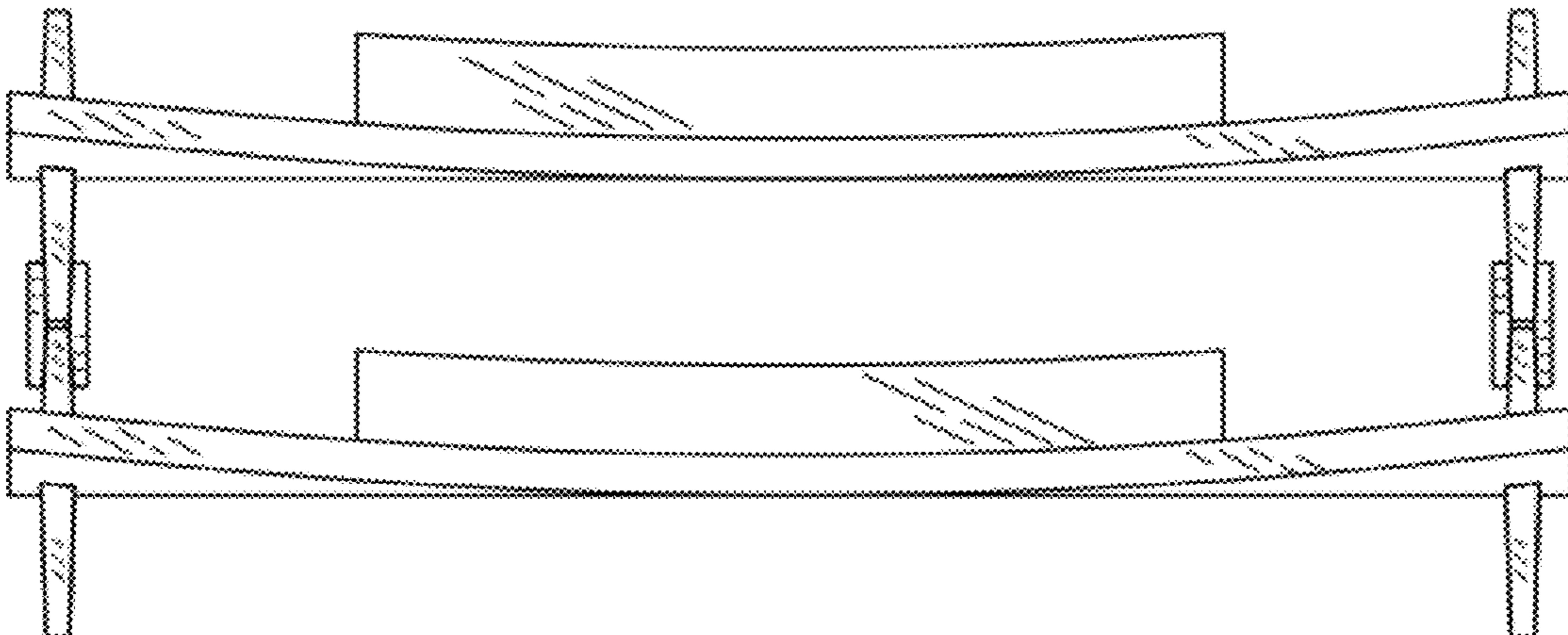

FIG. 10

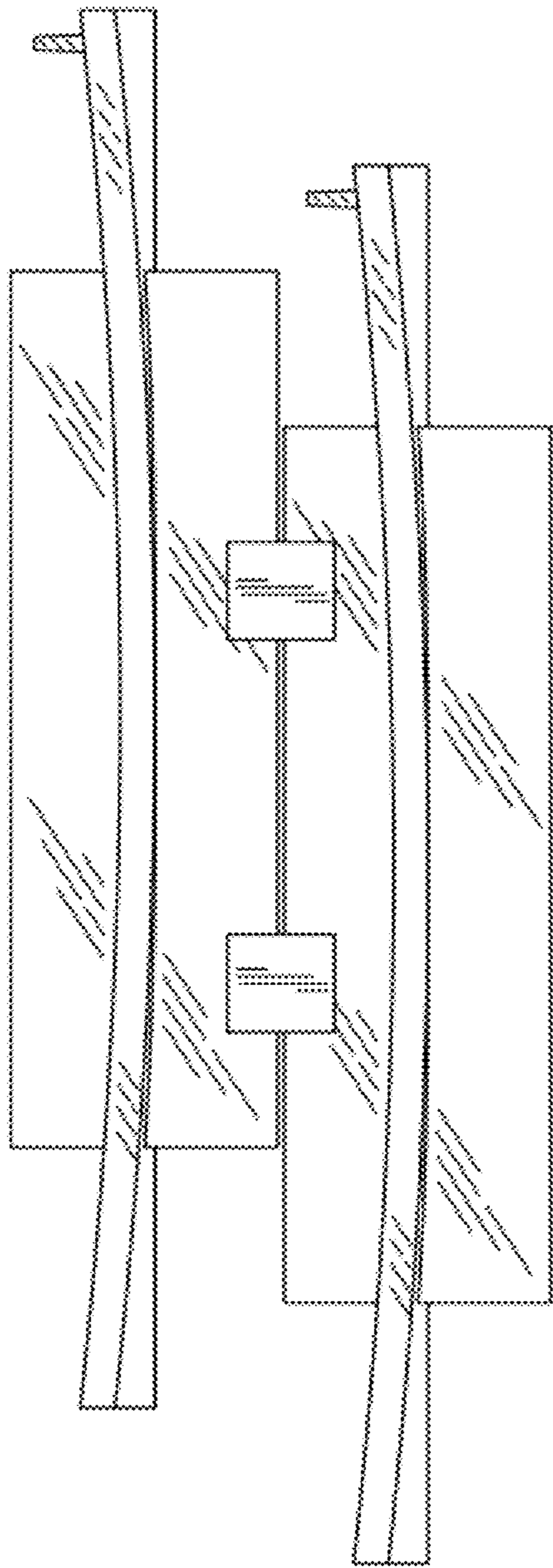

FIG. 11

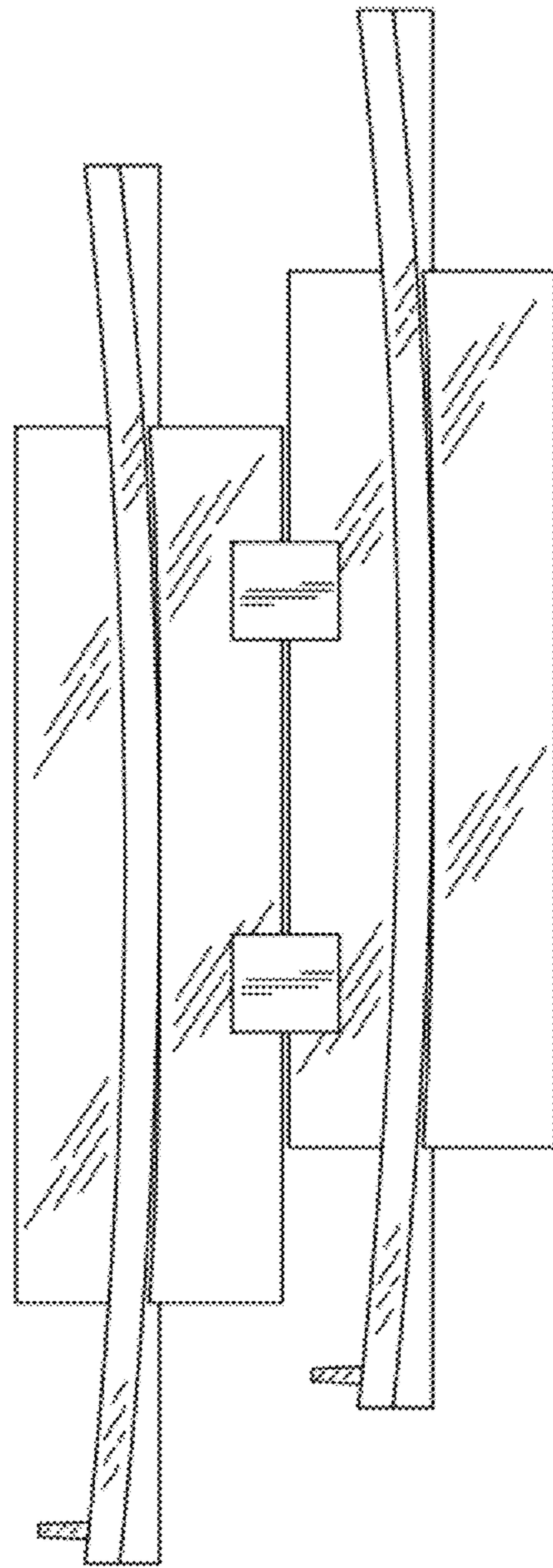

FIG. 12

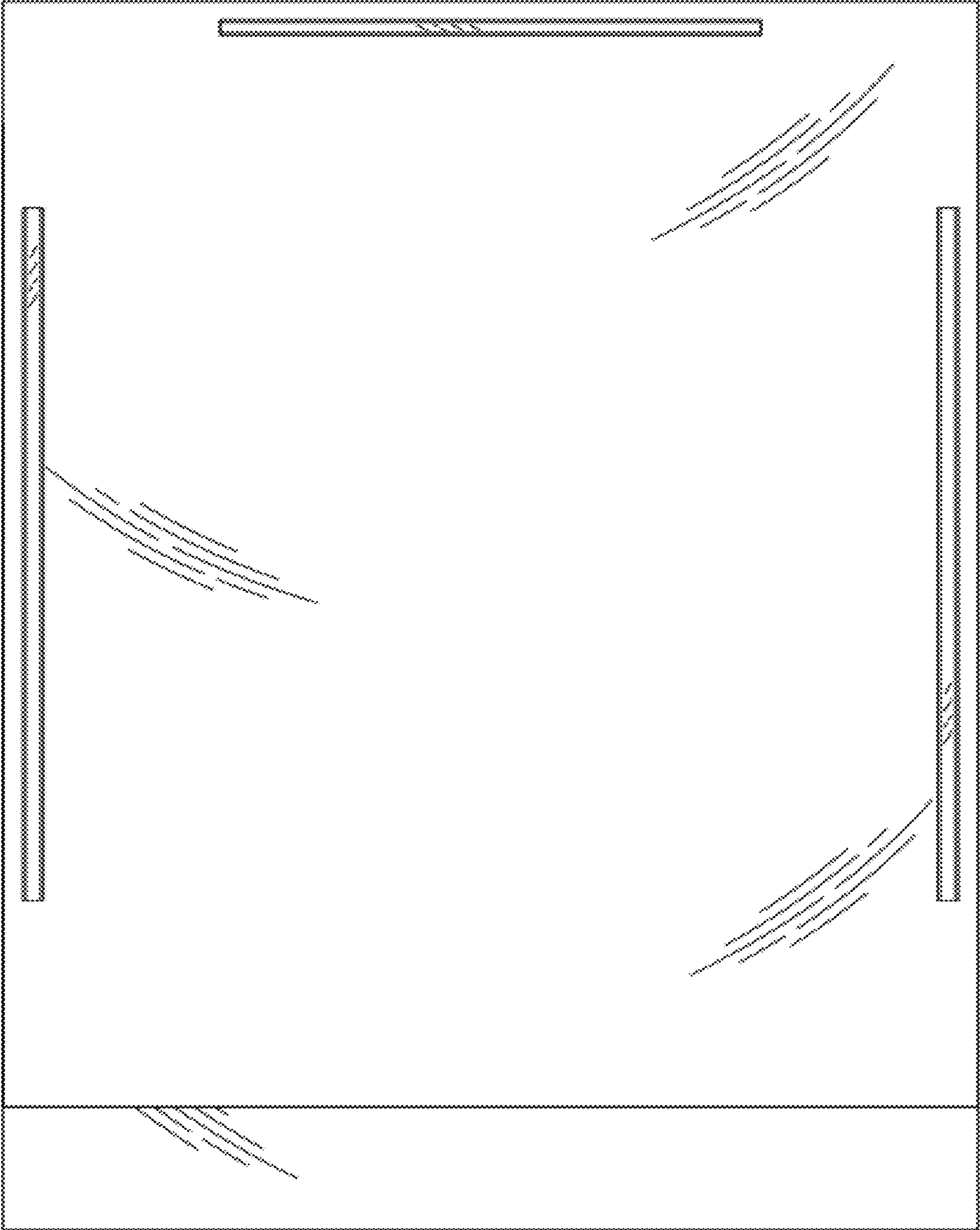

FIG. 13

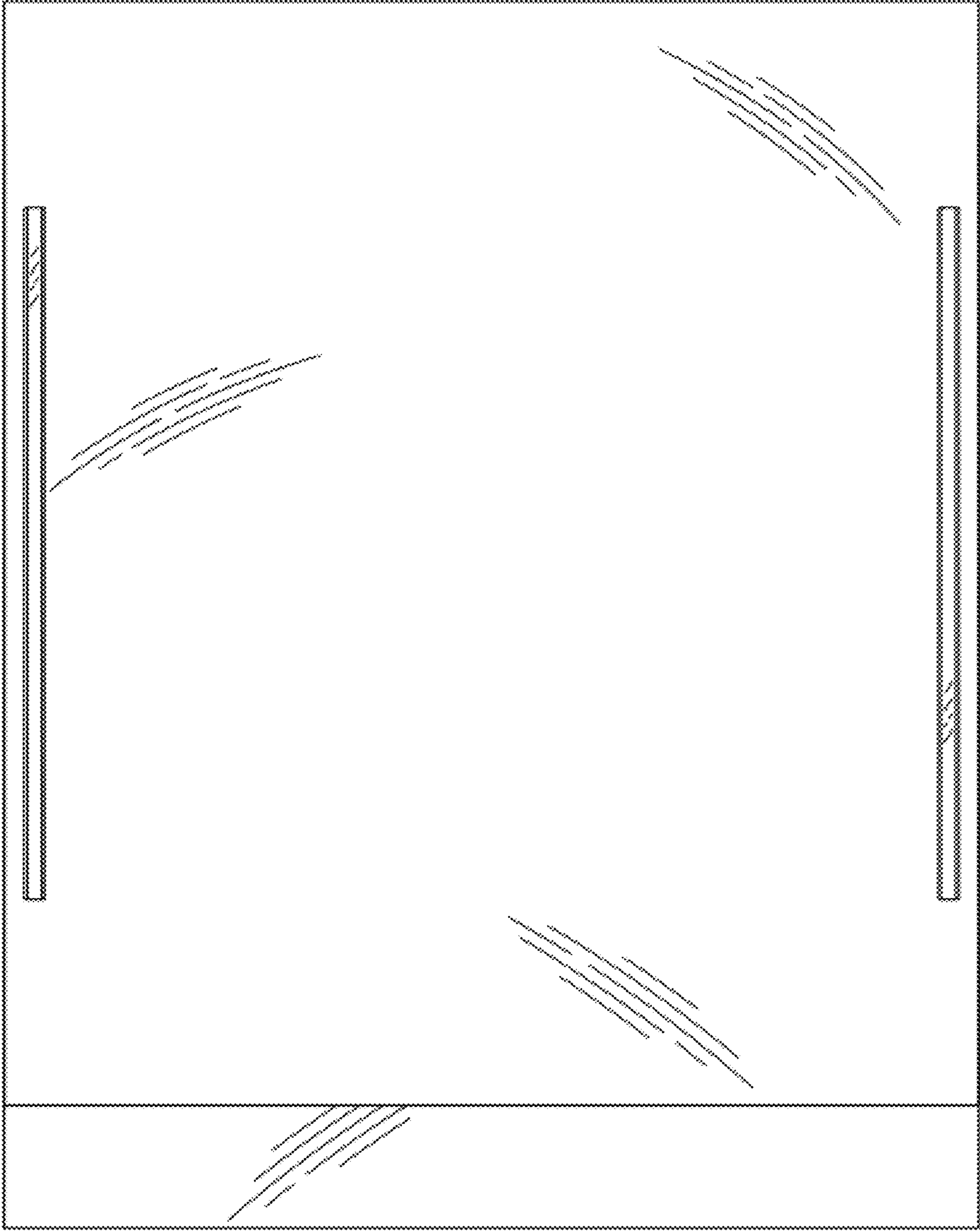

FIG. 14