



US00D665452S

(12) **United States Design Patent**
Dambricourt

(10) **Patent No.:** **US D665,452 S**

(45) **Date of Patent:** **** Aug. 14, 2012**

(54) **LETTER TRAY**

(75) Inventor: **Géry Dambricourt**, Escoutoux (FR)

(73) Assignee: **CEP Office Solutions** (FR)

(**) Term: **14 Years**

(21) Appl. No.: **29/388,990**

(22) Filed: **Apr. 5, 2011**

(30) **Foreign Application Priority Data**

Oct. 5, 2010 (EM) 001237911

(51) **LOC (9) Cl.** **19-02**

(52) **U.S. Cl.** **D19/92**

(58) **Field of Classification Search** D3/304,
D3/310, 313, 314, 315; D6/475, 510; D7/554.3;
D19/75, 77-92, 99, 100; 206/215, 449, 558;
211/126.1

See application file for complete search history.

(56) **References Cited**

U.S. PATENT DOCUMENTS

1,740,424	A *	12/1929	Blaine	206/449
2,100,720	A *	11/1937	Page	206/449
D144,450	S *	4/1946	Cohen	D19/92
2,704,974	A *	3/1955	Steman	99/422
D179,276	S *	11/1956	Abrahamson	D19/92
D179,534	S *	1/1957	Bullock et al.	D19/92
D207,851	S *	6/1967	Separa	D6/449
3,480,154	A *	11/1969	Telfer	211/126.5
D231,496	S *	4/1974	Saltz	D19/92
D232,934	S *	9/1974	Perry	D19/92
3,968,881	A *	7/1976	Beil et al.	211/126.12
D240,820	S *	8/1976	Beil	D19/92
D251,251	S *	3/1979	Tiedemann	D19/20
D260,907	S *	9/1981	Giulie et al.	D19/92
D270,356	S *	8/1983	Beltrami	D19/86
4,768,655	A *	9/1988	MacGregor	211/11
D316,116	S *	4/1991	Hawes et al.	D19/92
D334,774	S *	4/1993	Prey	D19/92

D368,116	S *	3/1996	Kozo	D19/92
5,624,037	A *	4/1997	Kozo	206/565
D425,937	S *	5/2000	Serrault et al.	D19/92
D428,059	S *	7/2000	Saylor et al.	D19/92
6,189,705	B1 *	2/2001	Saylor et al.	211/11
D455,786	S *	4/2002	Walz	D19/92
D461,995	S *	8/2002	Massaloux et al.	D7/554.3
D497,781	S *	11/2004	Joseph	D7/641
D544,037	S *	6/2007	Bonaventura	D19/92
D553,688	S *	10/2007	Bonaventura	D19/92
D555,204	S *	11/2007	Smith et al.	D19/92
D571,408	S *	6/2008	Smith et al.	D19/92
D641,210	S *	7/2011	Hamilton	D7/554.3
D642,829	S *	8/2011	Spindelbalker	D6/491

* cited by examiner

Primary Examiner — Elizabeth Albert

(74) *Attorney, Agent, or Firm* — Banner & Witcoff, Ltd.

(57) **CLAIM**

The ornamental design for a letter tray, as shown and described.

DESCRIPTION

FIG. 1 is a perspective view of a letter tray showing my new design;

FIG. 2 is a front elevational view thereof;

FIG. 3 is a rear elevational view thereof;

FIG. 4 is a right side elevational view thereof;

FIG. 5 is a left side elevational view thereof;

FIG. 6 is a top plan view thereof;

FIG. 7 is a bottom plan view thereof;

FIG. 8 is a perspective view of the letter tray of FIGS. 1-7 with the lines visible through the translucent surfaces being removed for clarity;

FIG. 9 is a front elevational view thereof;

FIG. 10 is a rear elevational view thereof;

FIG. 11 is a right side elevational view thereof;

FIG. 12 is a left side elevational view thereof;

FIG. 13 is a top plan view thereof; and,

FIG. 14 is a bottom plan view thereof.

1 Claim, 10 Drawing Sheets

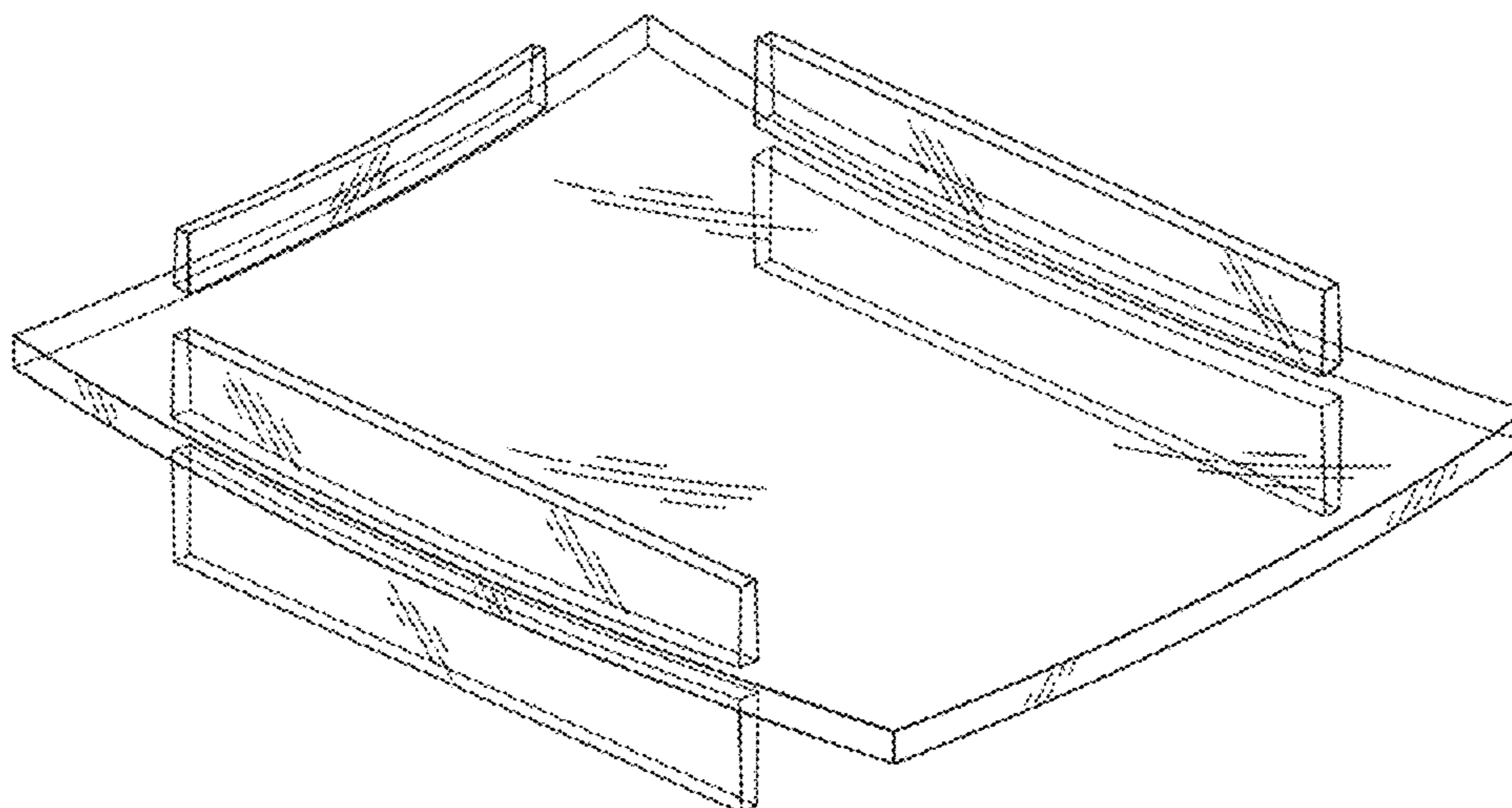

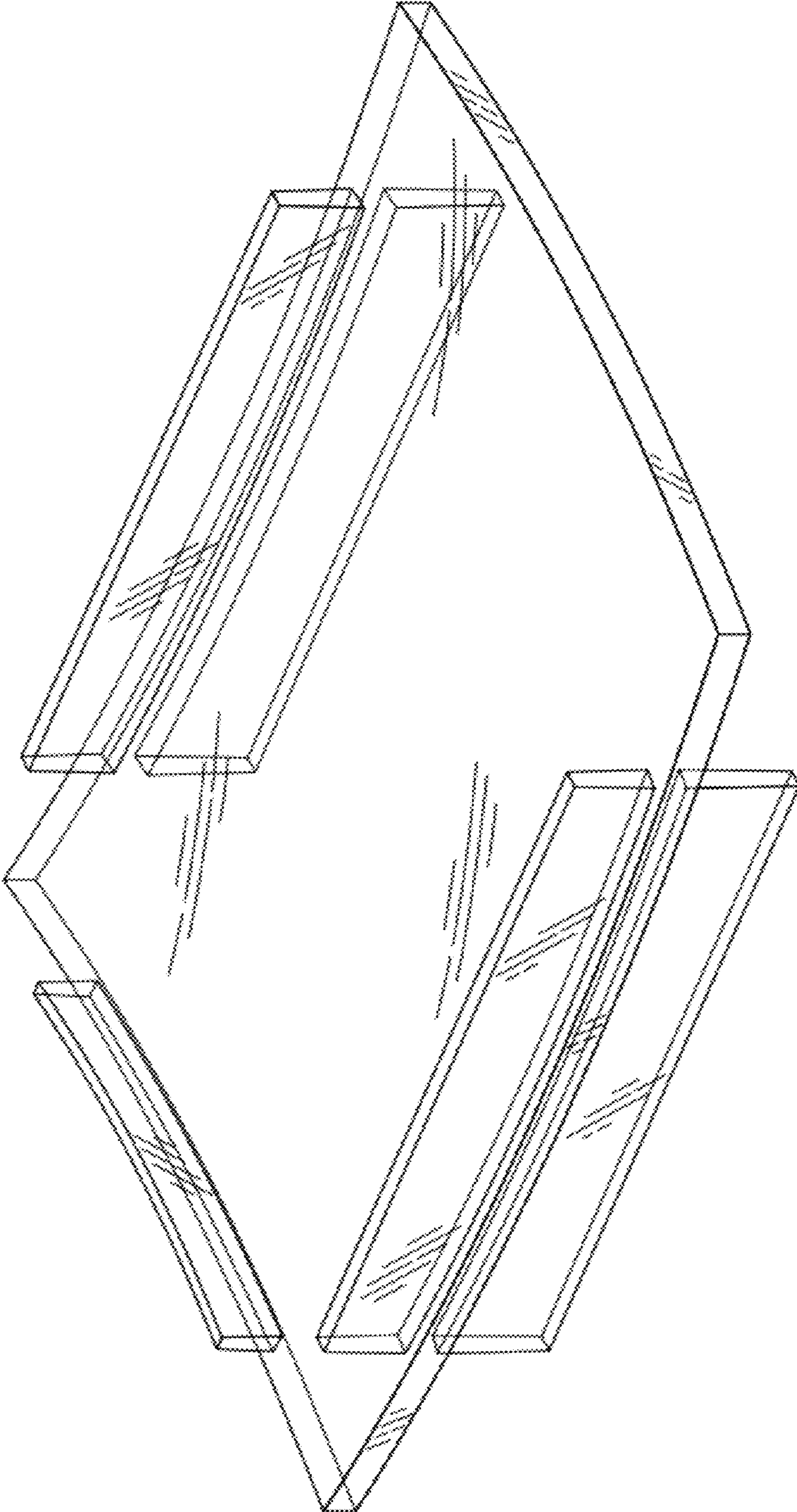

FIG. 1

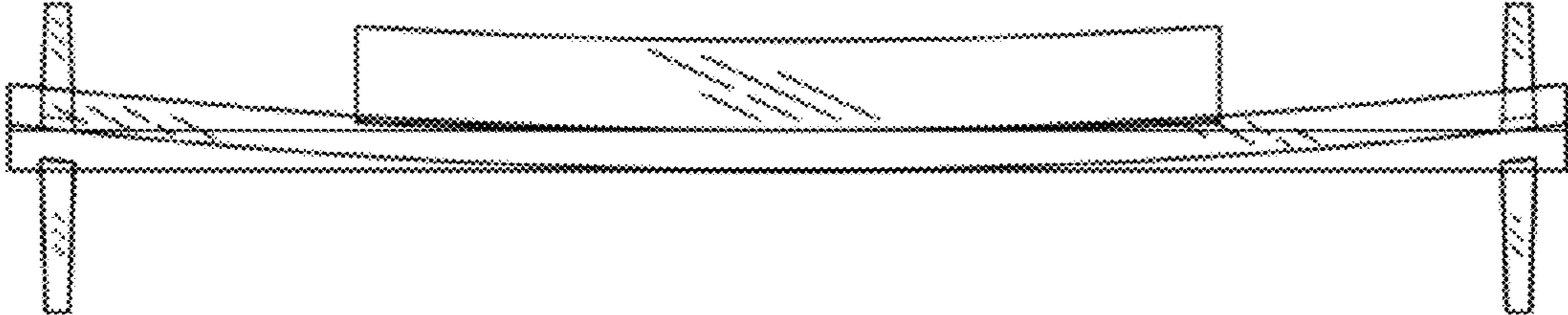

FIG. 2

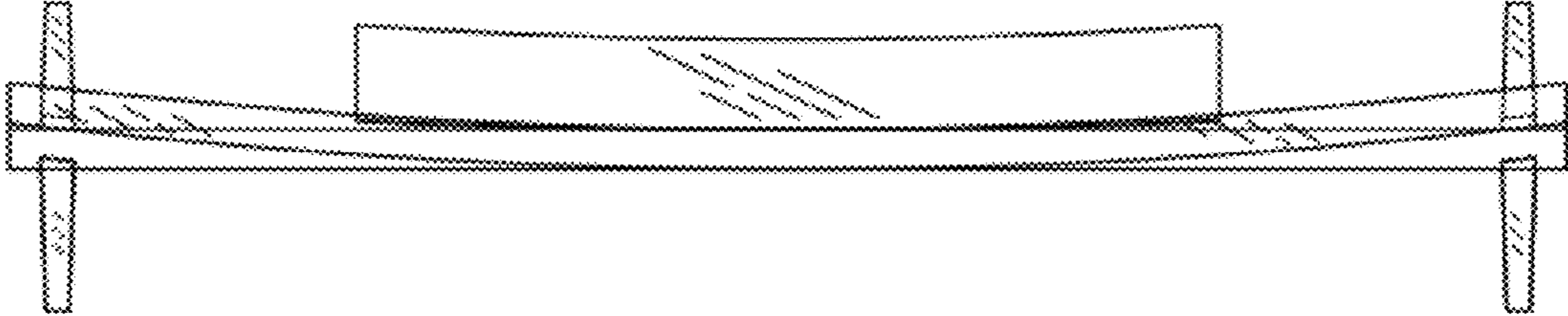

FIG. 3

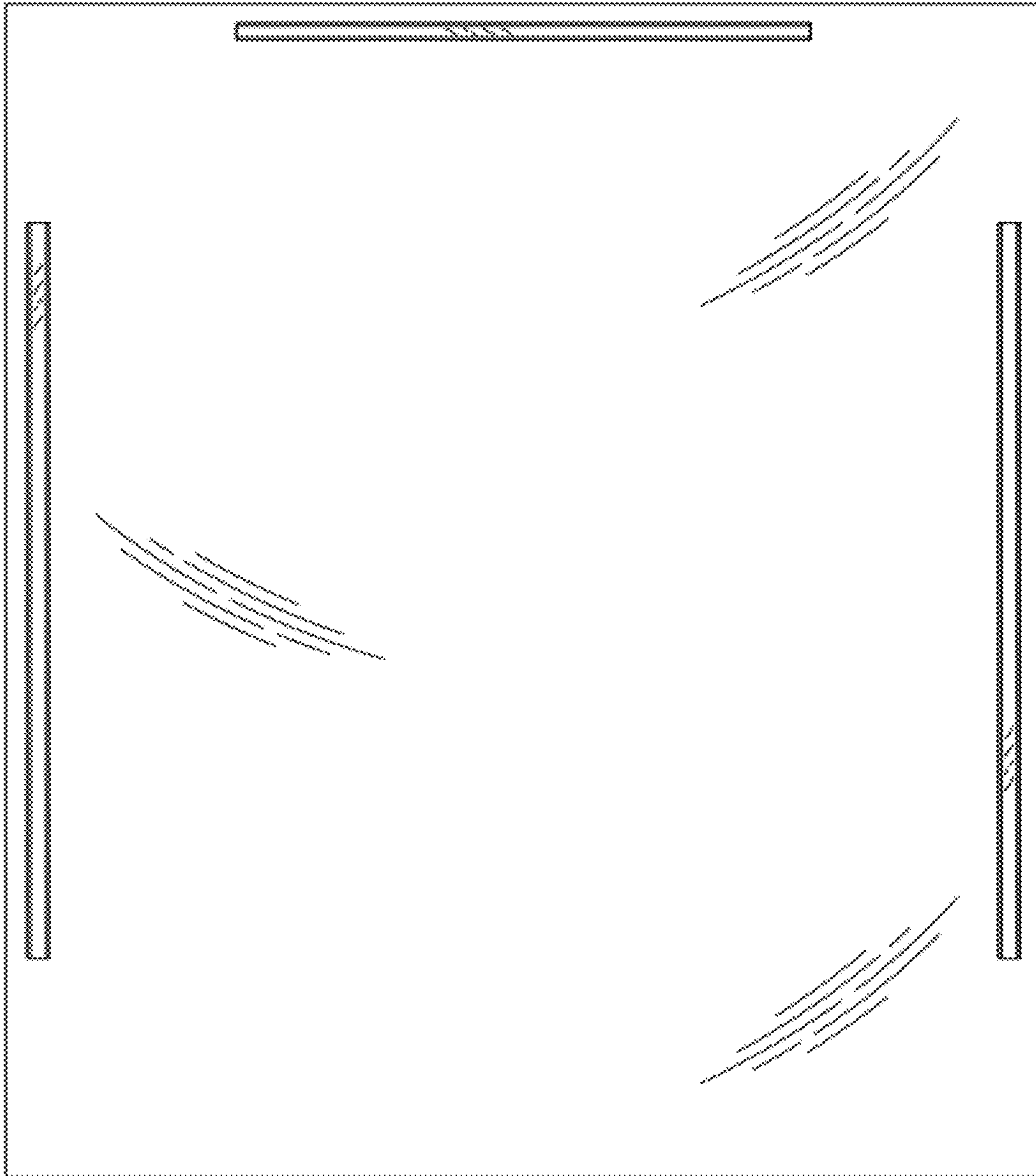

FIG. 6

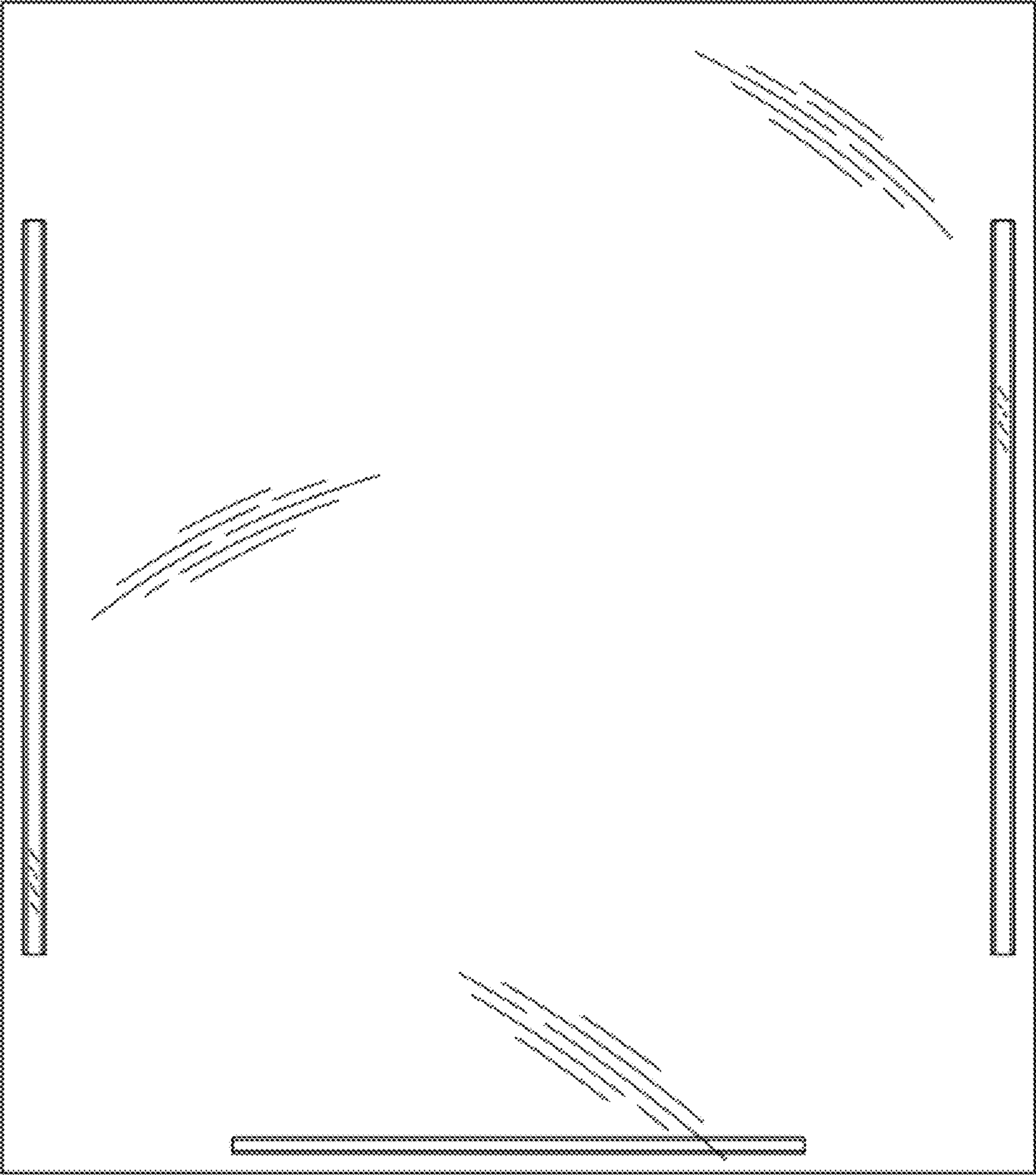

FIG. 7

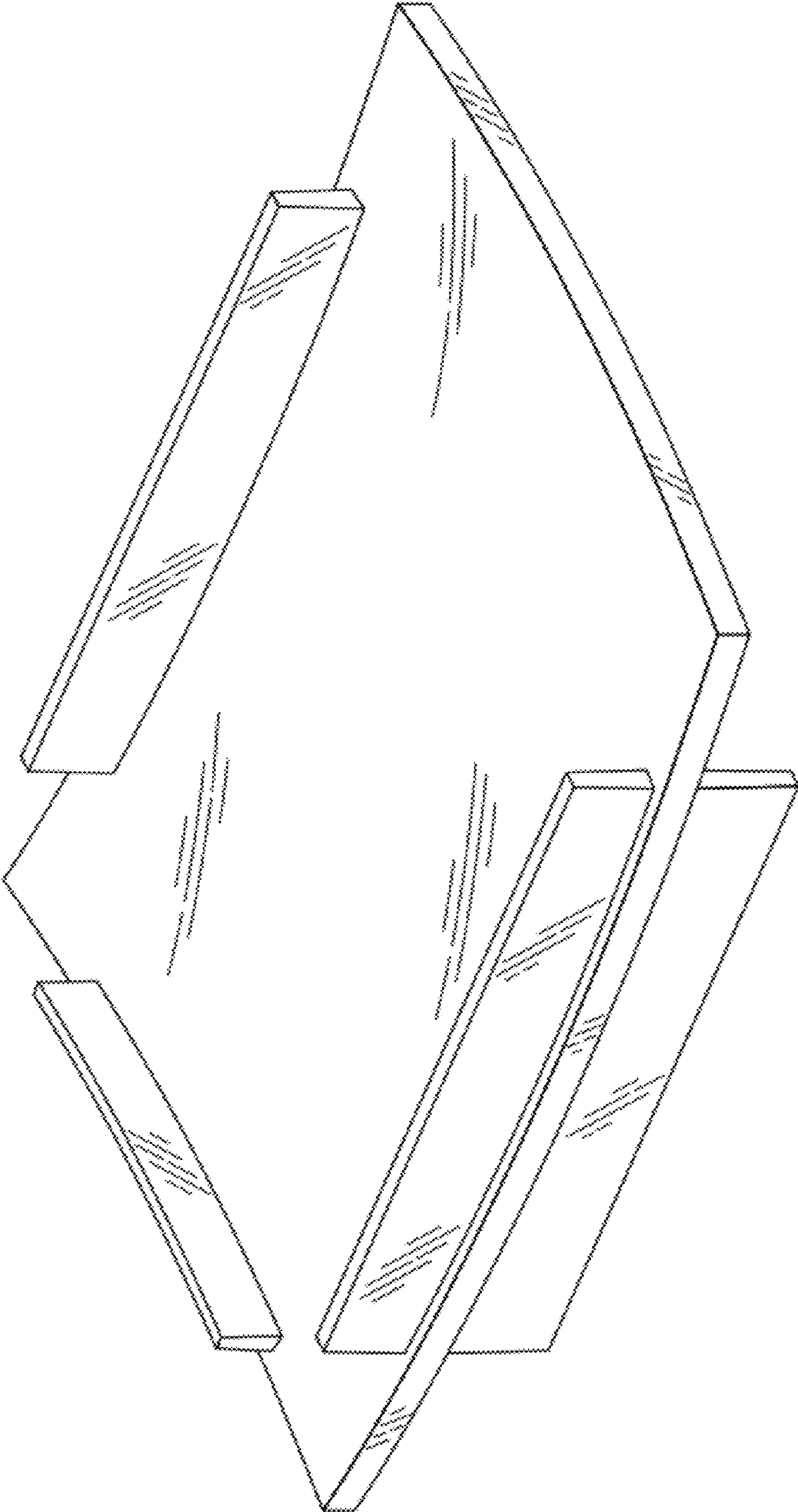

FIG. 8

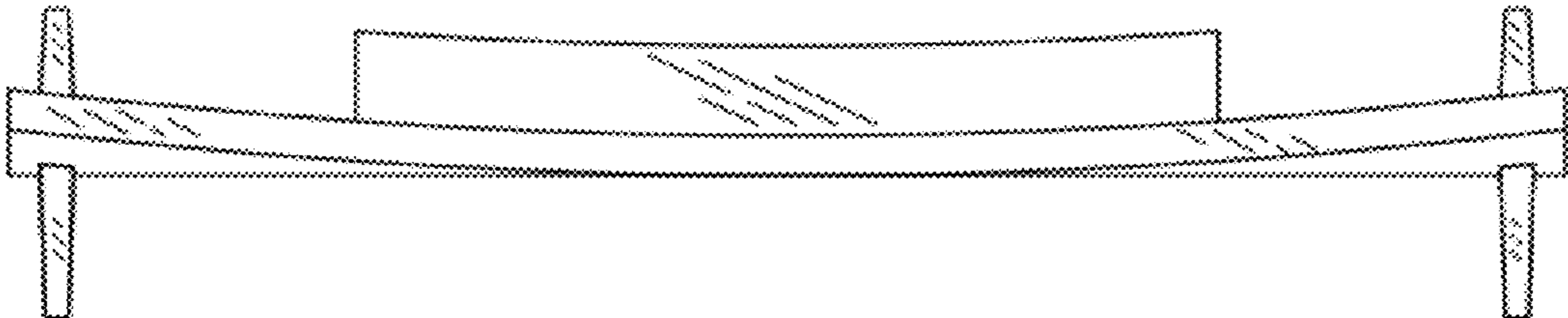

FIG. 9

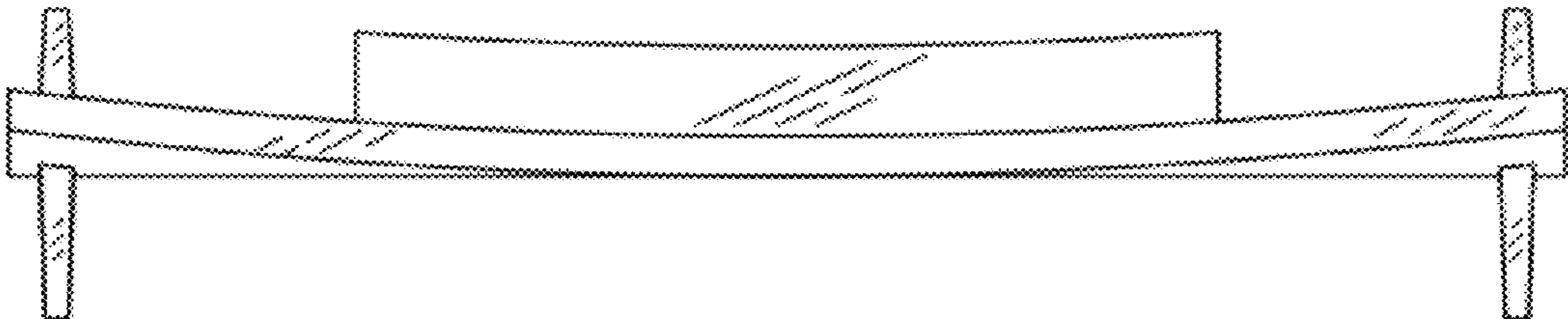

FIG. 10

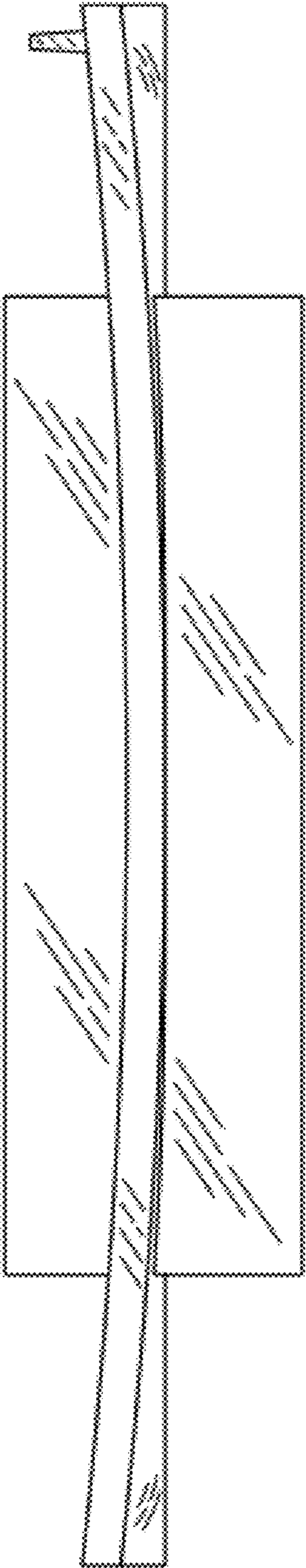

FIG. 11

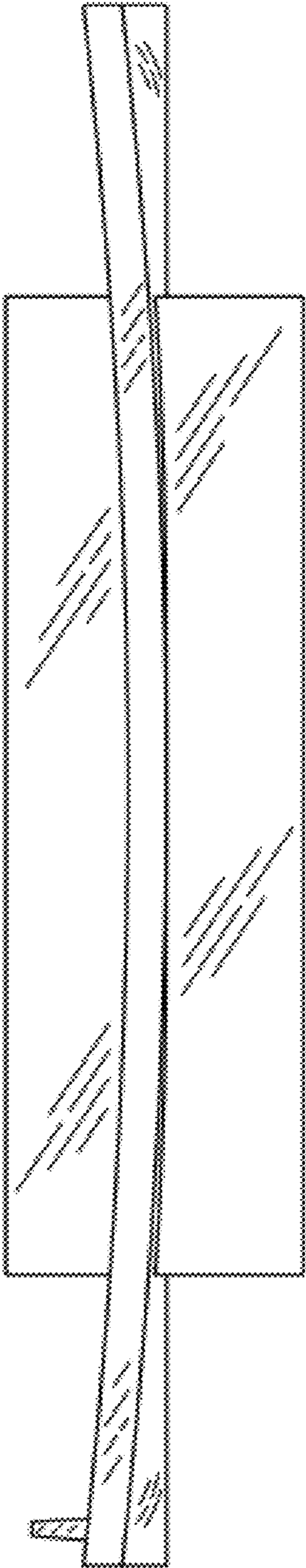

FIG. 12

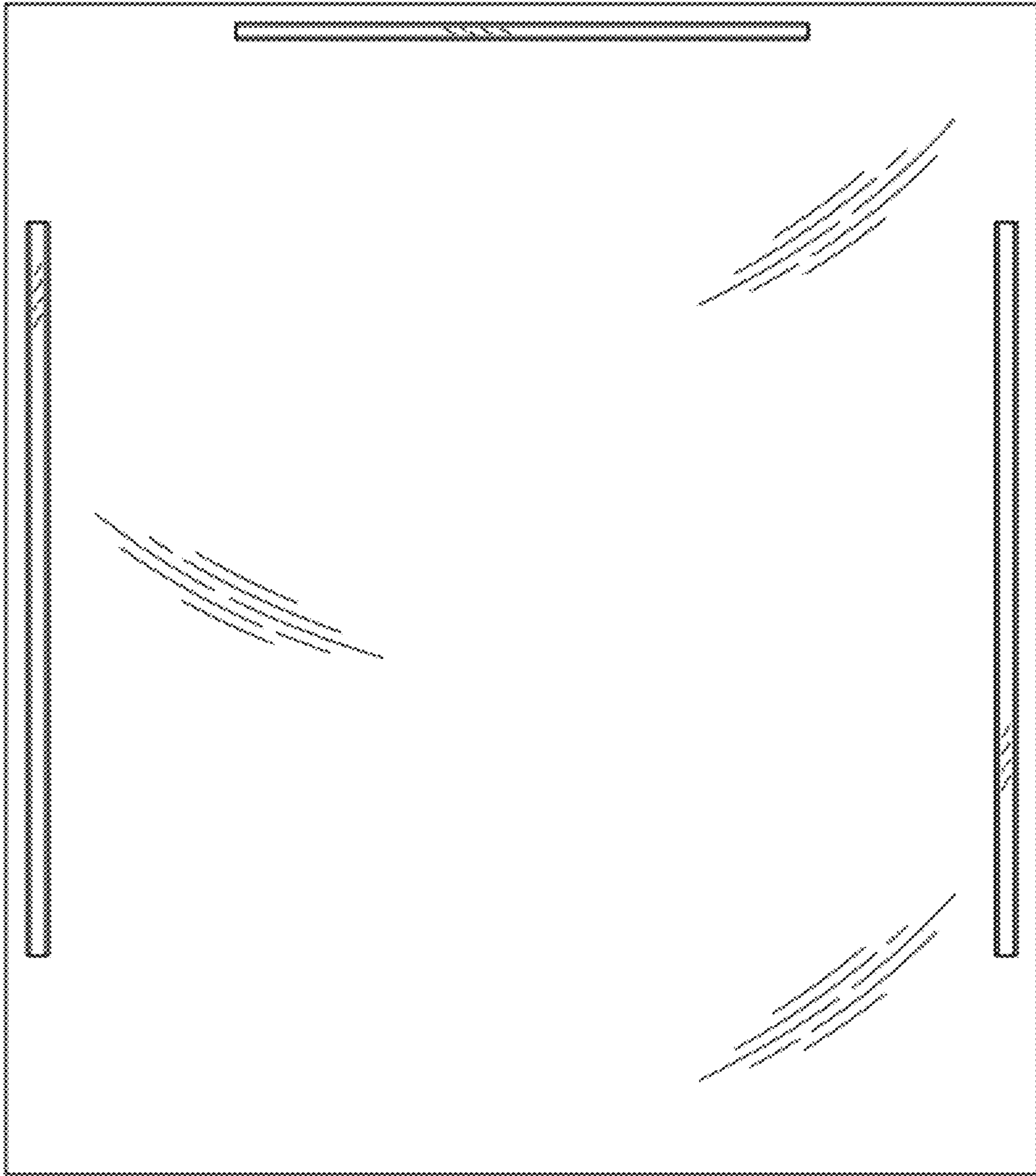

FIG. 13

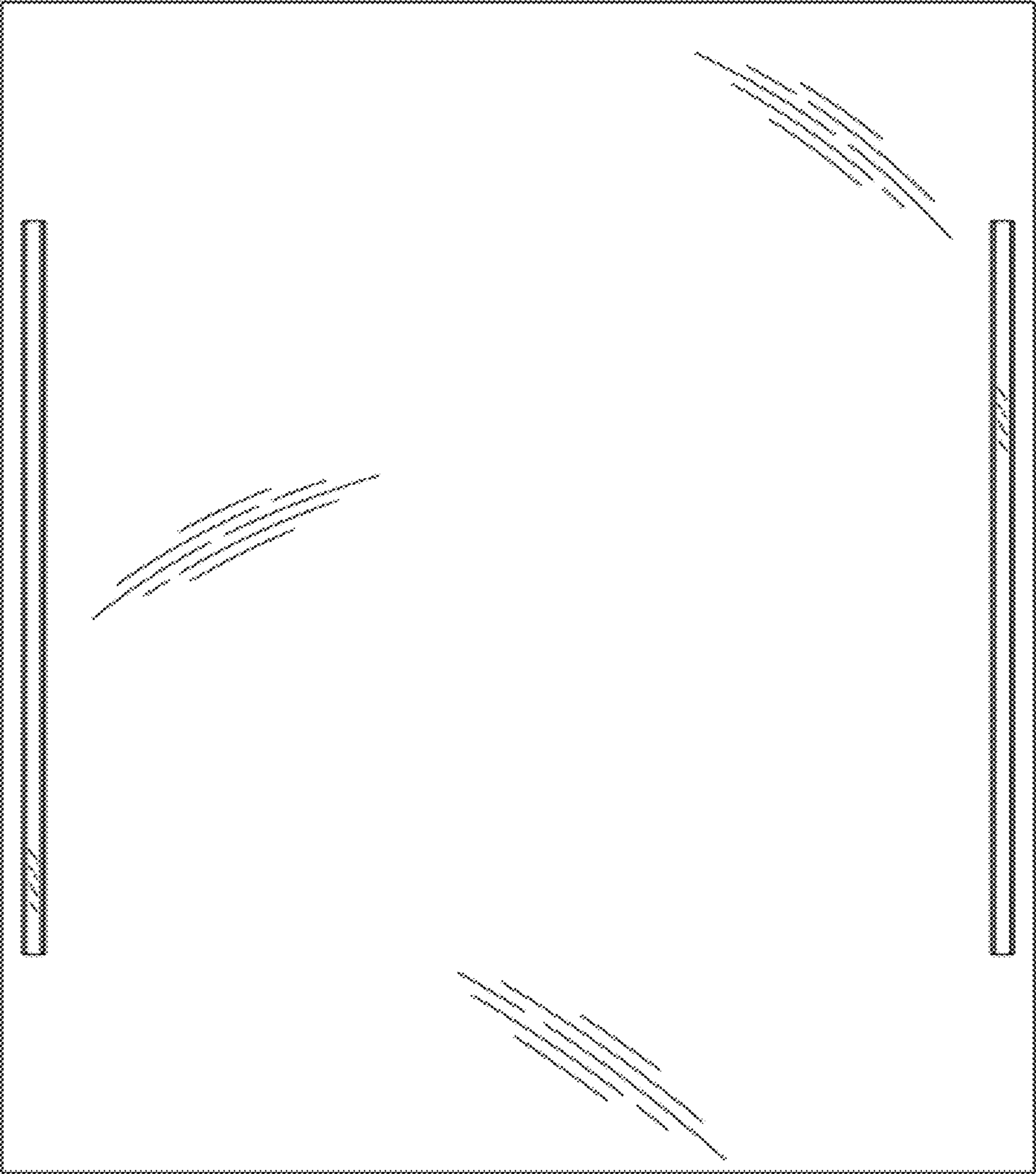

FIG. 14