



US00D665446S

(12) **United States Design Patent**
Mayer et al.

(10) **Patent No.:** **US D665,446 S**

(45) **Date of Patent:** **** Aug. 14, 2012**

(54) **GREETING CARD**

(75) Inventors: **David Mayer**, Bay Village, OH (US);
Lynne Shlonsky, Shaker Heights, OH (US); **David Sapp**, Avon Lake, OH (US);
John Talbot, Bay Village, OH (US); **Seth Larson**, Lakewood, OH (US);
Gary Nelson, Avon, OH (US); **Carol Miller**, Twinsburg, OH (US)

(73) Assignee: **American Greetings Corporation**,
Cleveland, OH (US)

(**) Term: **14 Years**

(21) Appl. No.: **29/408,095**

(22) Filed: **Dec. 7, 2011**

(51) **LOC (9) Cl.** **19-01**

(52) **U.S. Cl.** **D19/2**

(58) **Field of Classification Search** D19/1-10,
D19/82, 100, 26, 32; D9/430-433, 414,
D9/415, 420, 423; 229/120.21, 92.8, 92,
229/92.1, 300-303, 117.01, 116.1, 132; 428/68,
428/542.6; 220/4.23; D3/218; D20/40;
283/2-4, 117; 206/45.28, 45.23, 45.25, 767,
206/232, 387.1, 424, 308.3; 446/147;
40/124.01-124.15, 455, 672

See application file for complete search history.

(56) **References Cited**

U.S. PATENT DOCUMENTS

2,407,592 A * 9/1946 Wathen 40/124.15
D400,919 S * 11/1998 Pickel D19/1

D632,330 S * 2/2011 Qiao et al. D19/1
D632,734 S * 2/2011 Qiao et al. D19/1
D657,816 S * 4/2012 Chambers D19/1
D658,230 S * 4/2012 Segal et al. D19/2

* cited by examiner

Primary Examiner — Richard E Chilcot

Assistant Examiner — Abraham Bahta

(74) *Attorney, Agent, or Firm* — Roetzel & Andress

(57) **CLAIM**

The ornamental design of a greeting card, as shown and described.

DESCRIPTION

FIG. 1 is a perspective view of a first embodiment of the greeting card showing our new design;
FIG. 2 is a left side view thereof;
FIG. 3 is a right side view thereof;
FIG. 4 is a front view thereof;
FIG. 5 is a rear view thereof;
FIG. 6 is a top view thereof;
FIG. 7 is a bottom view thereof;
FIG. 8 is a perspective view of the greeting card, with open flap;
FIG. 9 is a perspective view of a second embodiment of the greeting card;
FIG. 10 is a left side view thereof;
FIG. 11 is a right side view thereof;
FIG. 12 is a front view thereof;
FIG. 13 is a rear view thereof;
FIG. 14 is a top view thereof; and,
FIG. 15 is a bottom view thereof.

1 Claim, 7 Drawing Sheets

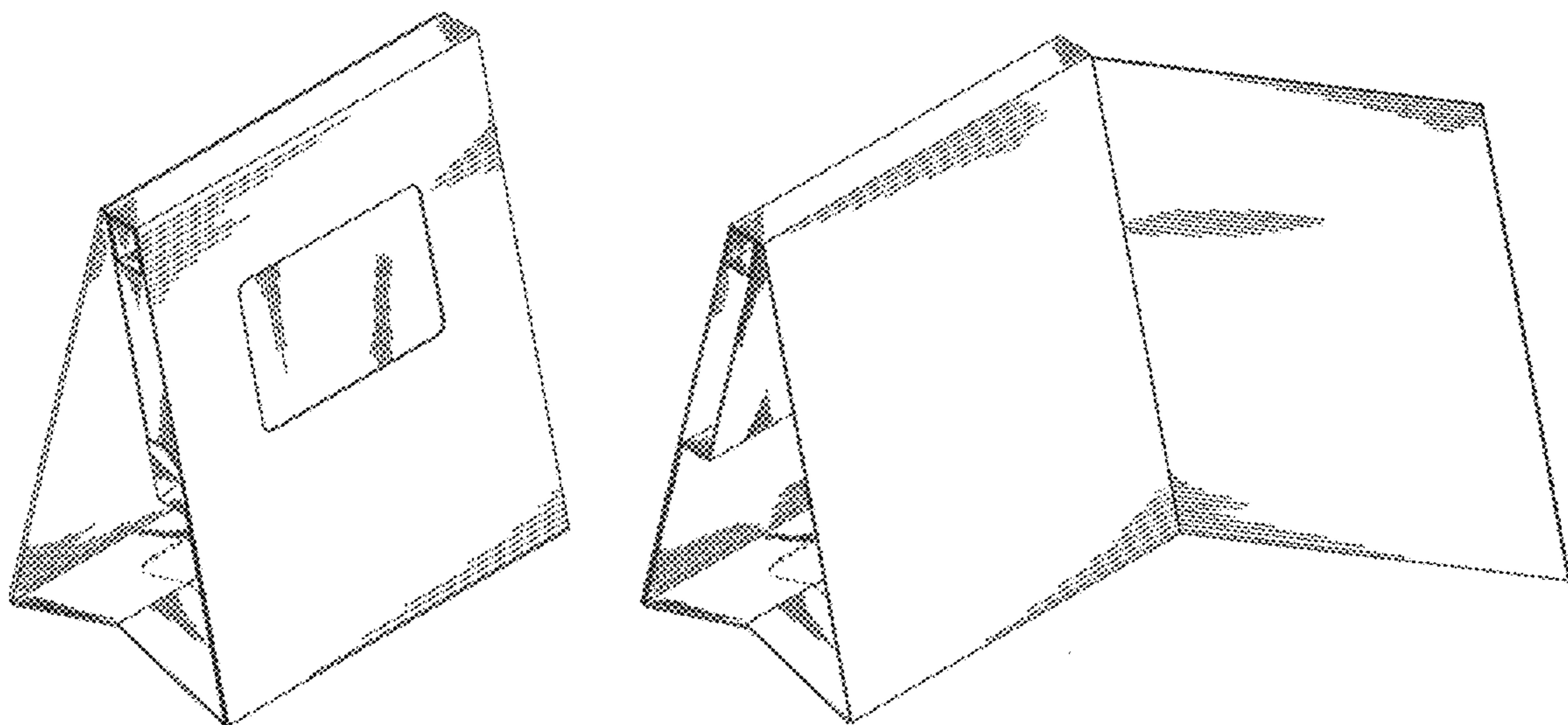

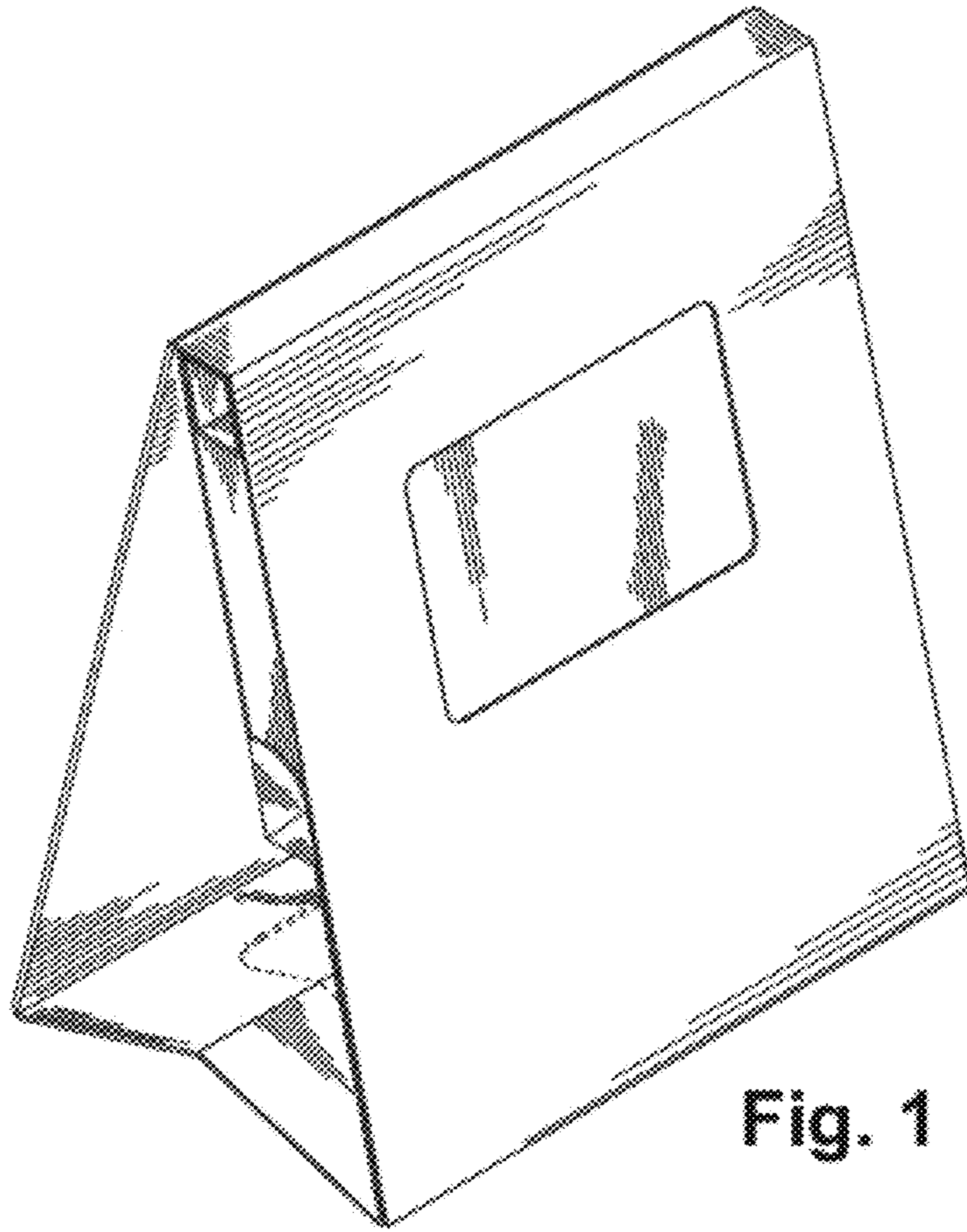

Fig. 1

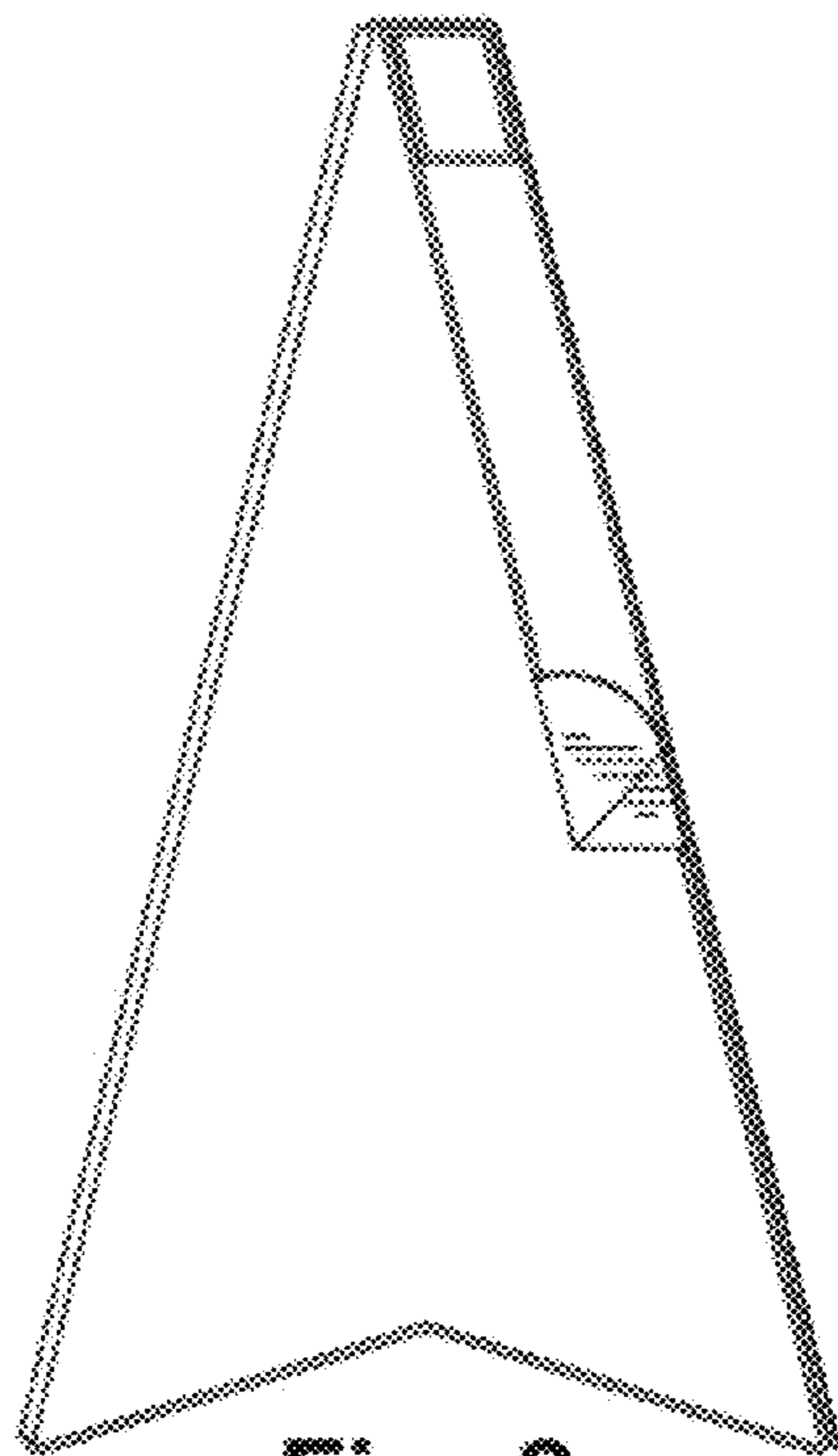

Fig. 2

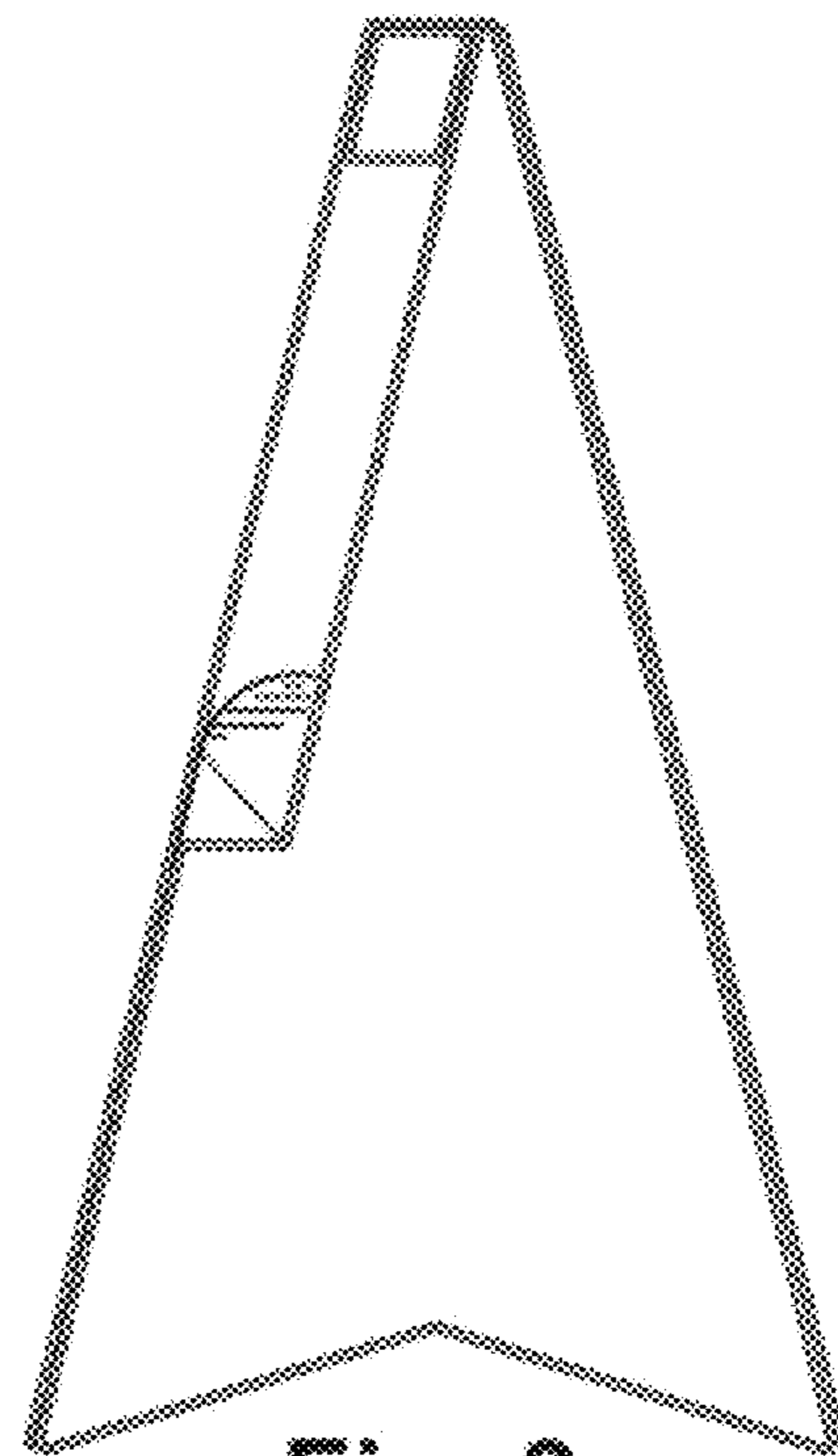

Fig. 3

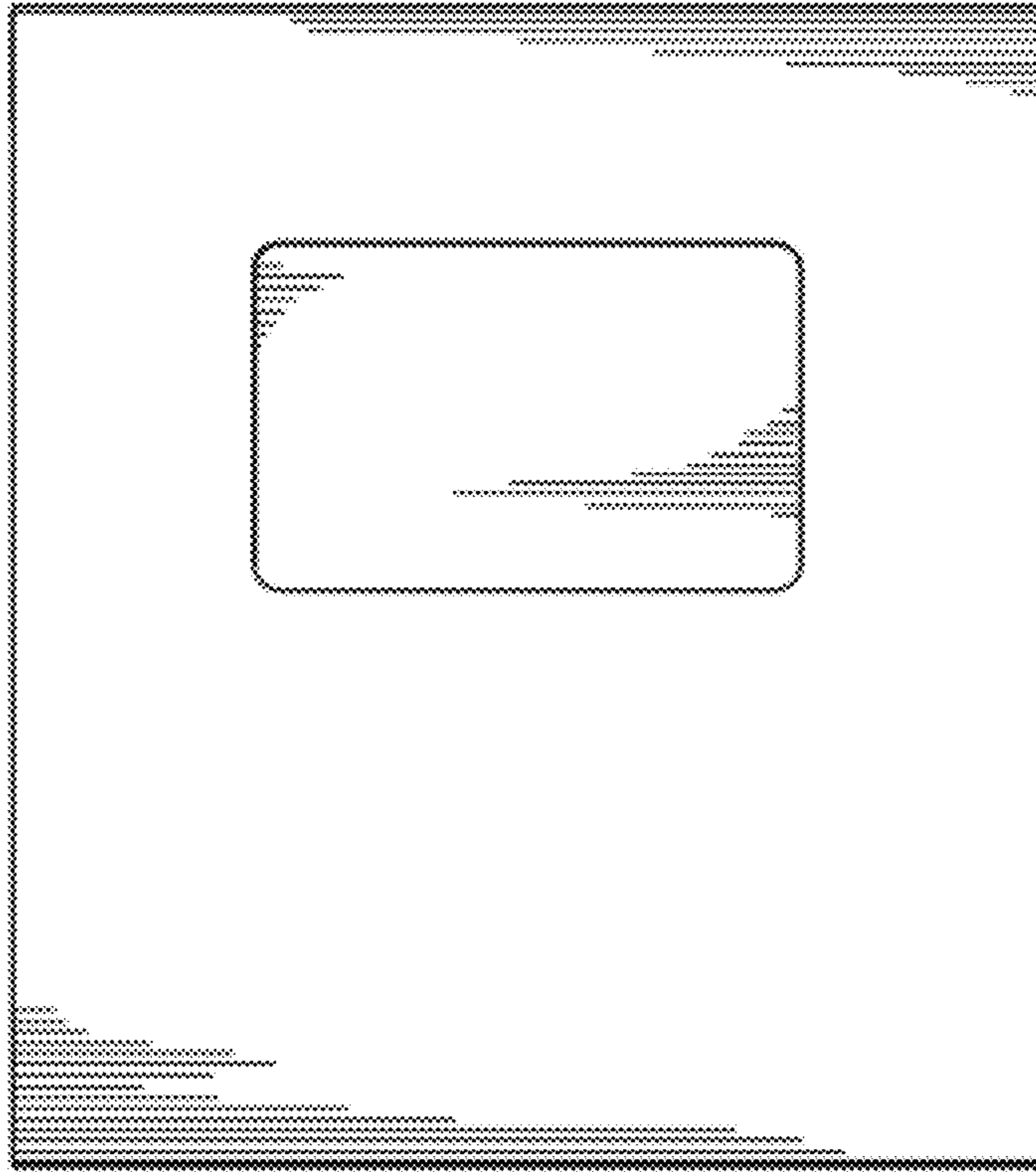

Fig. 4

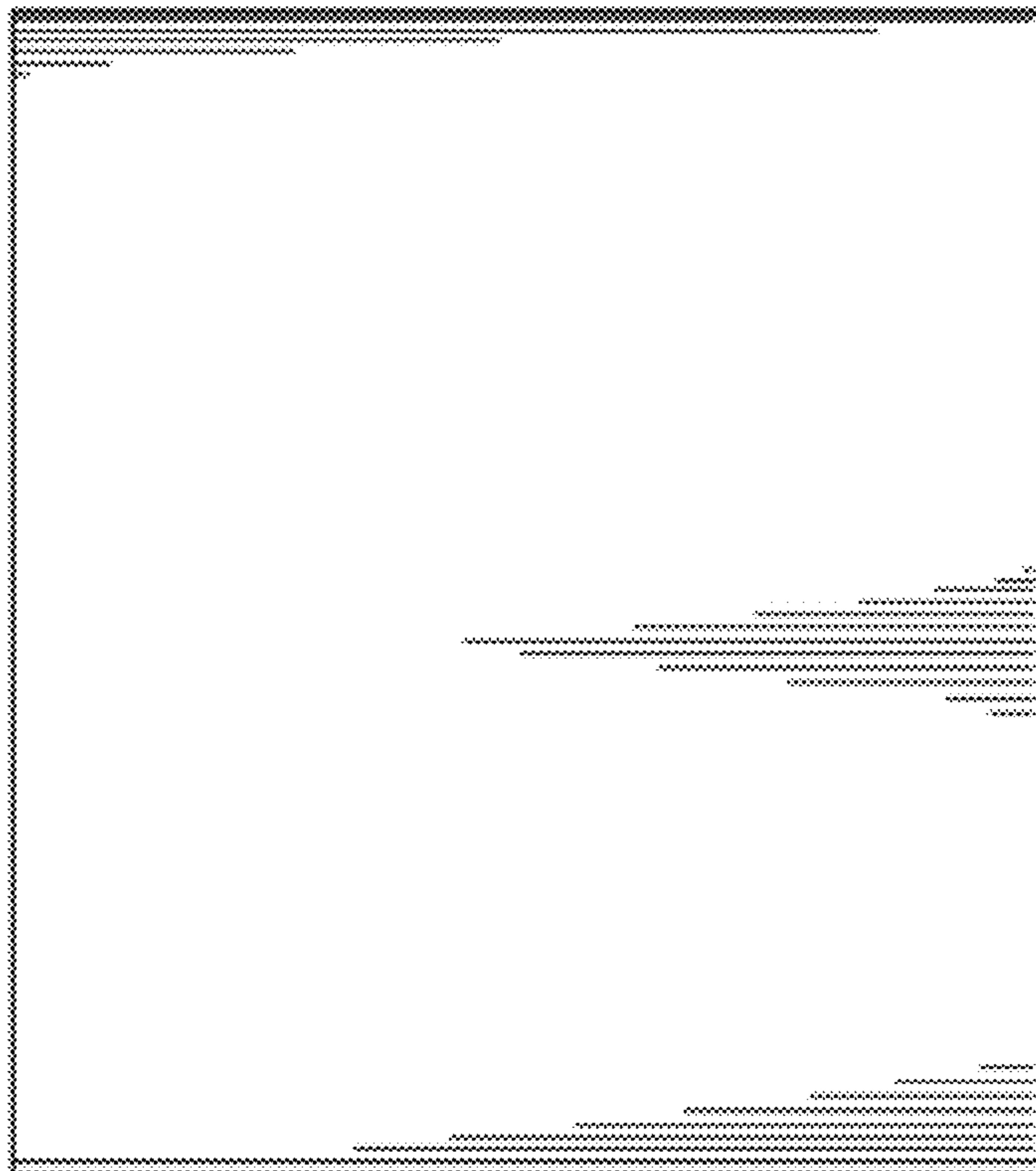

Fig. 5

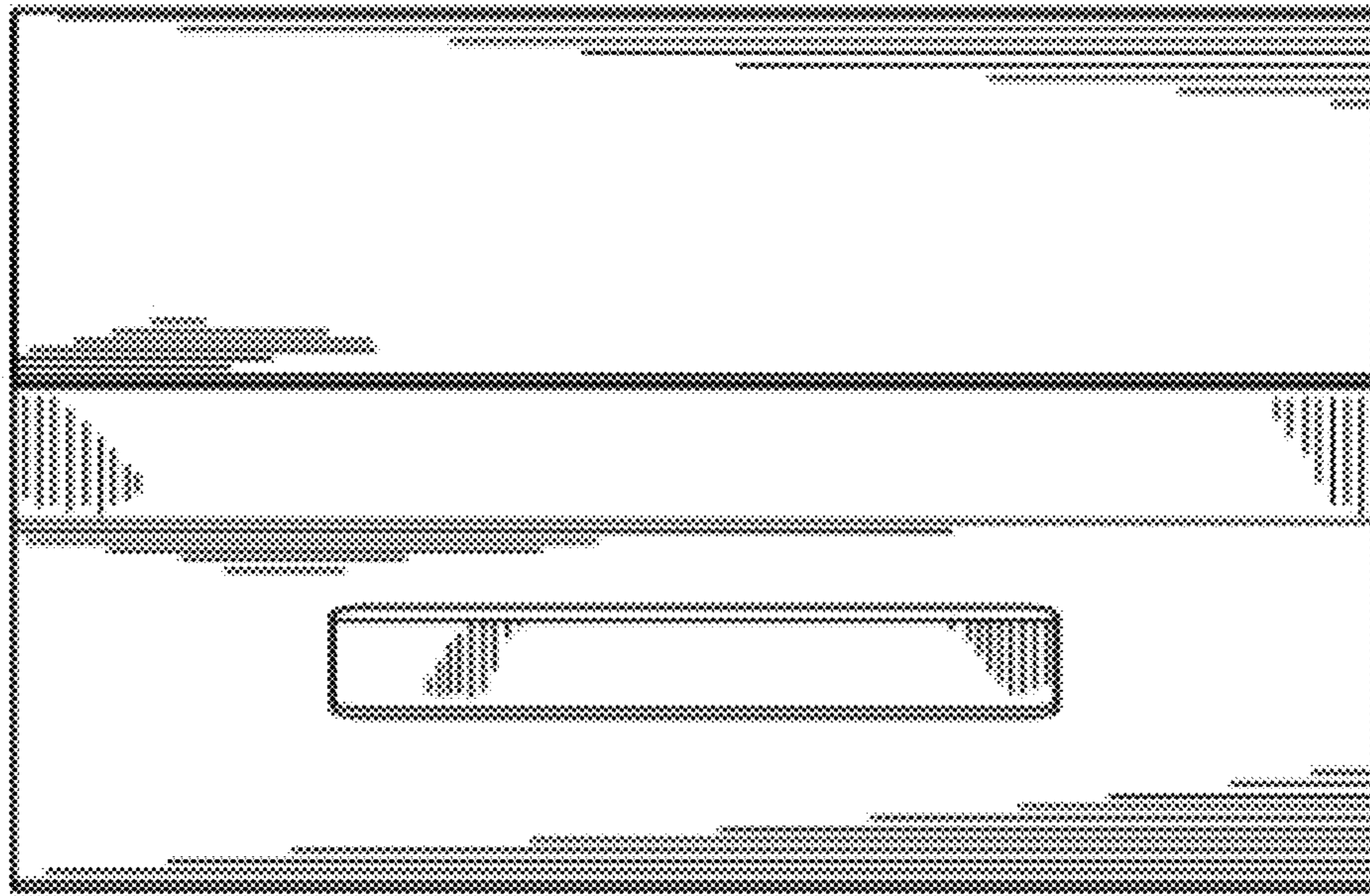

Fig. 6

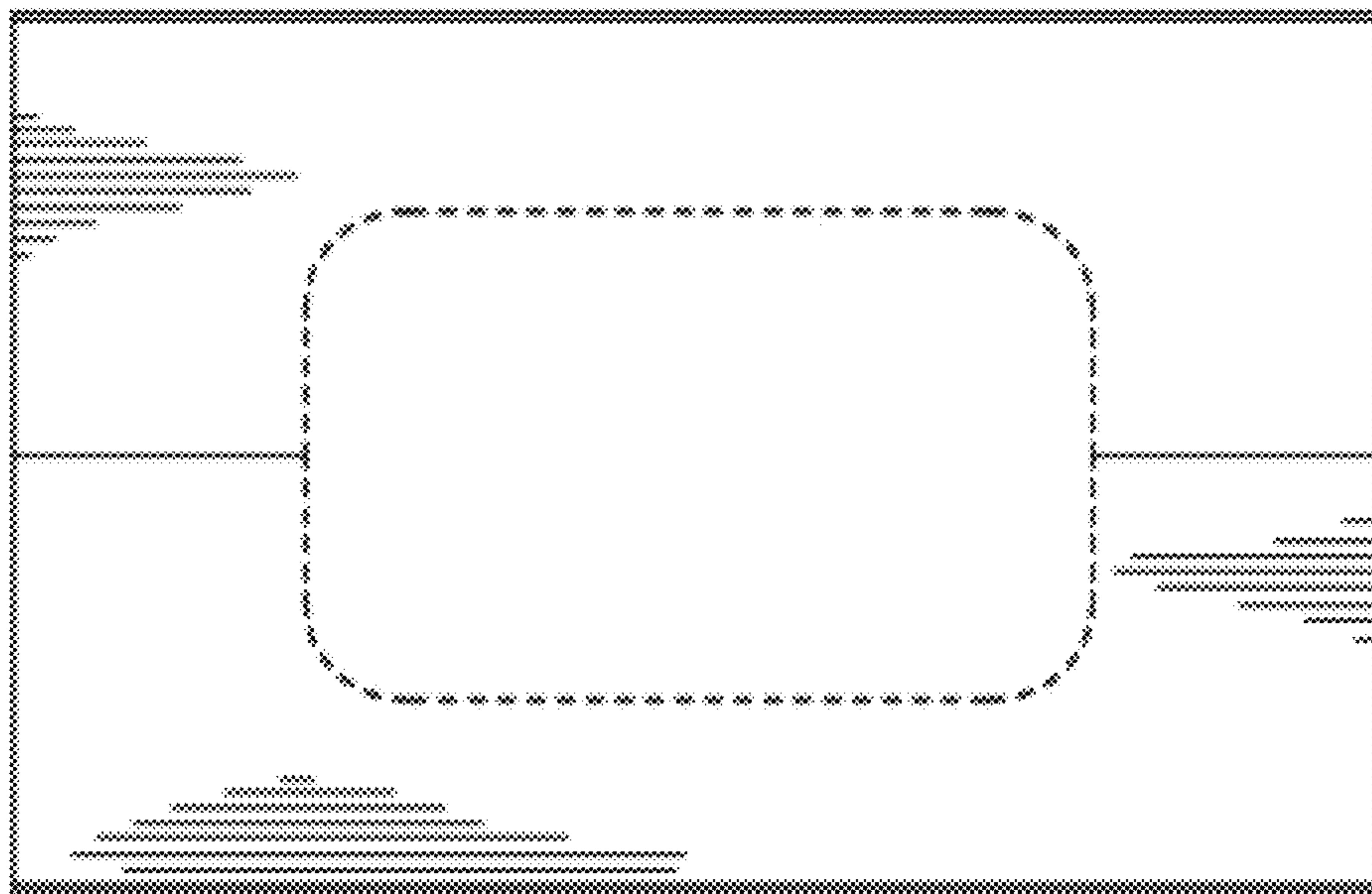

Fig. 7

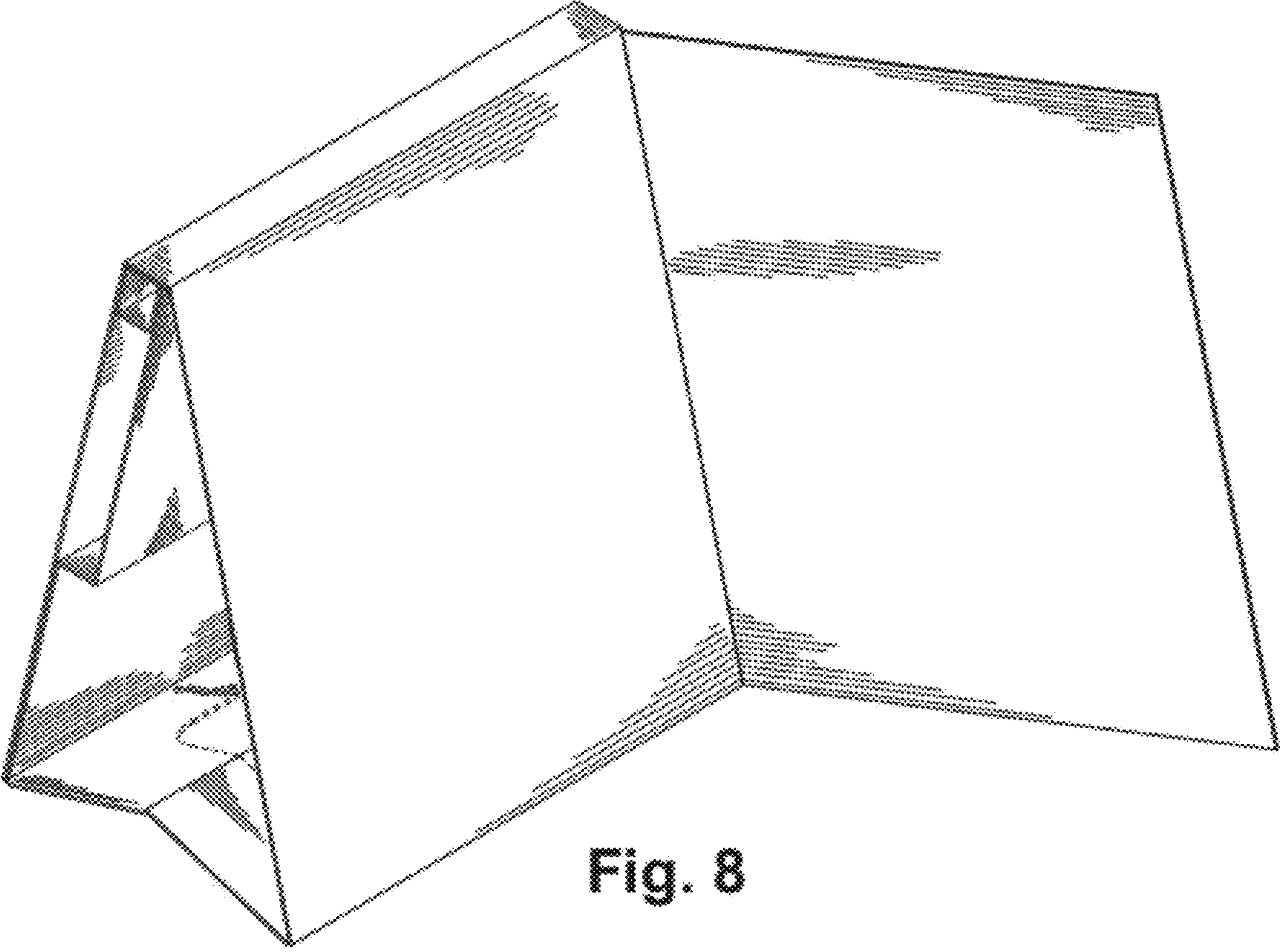

Fig. 8

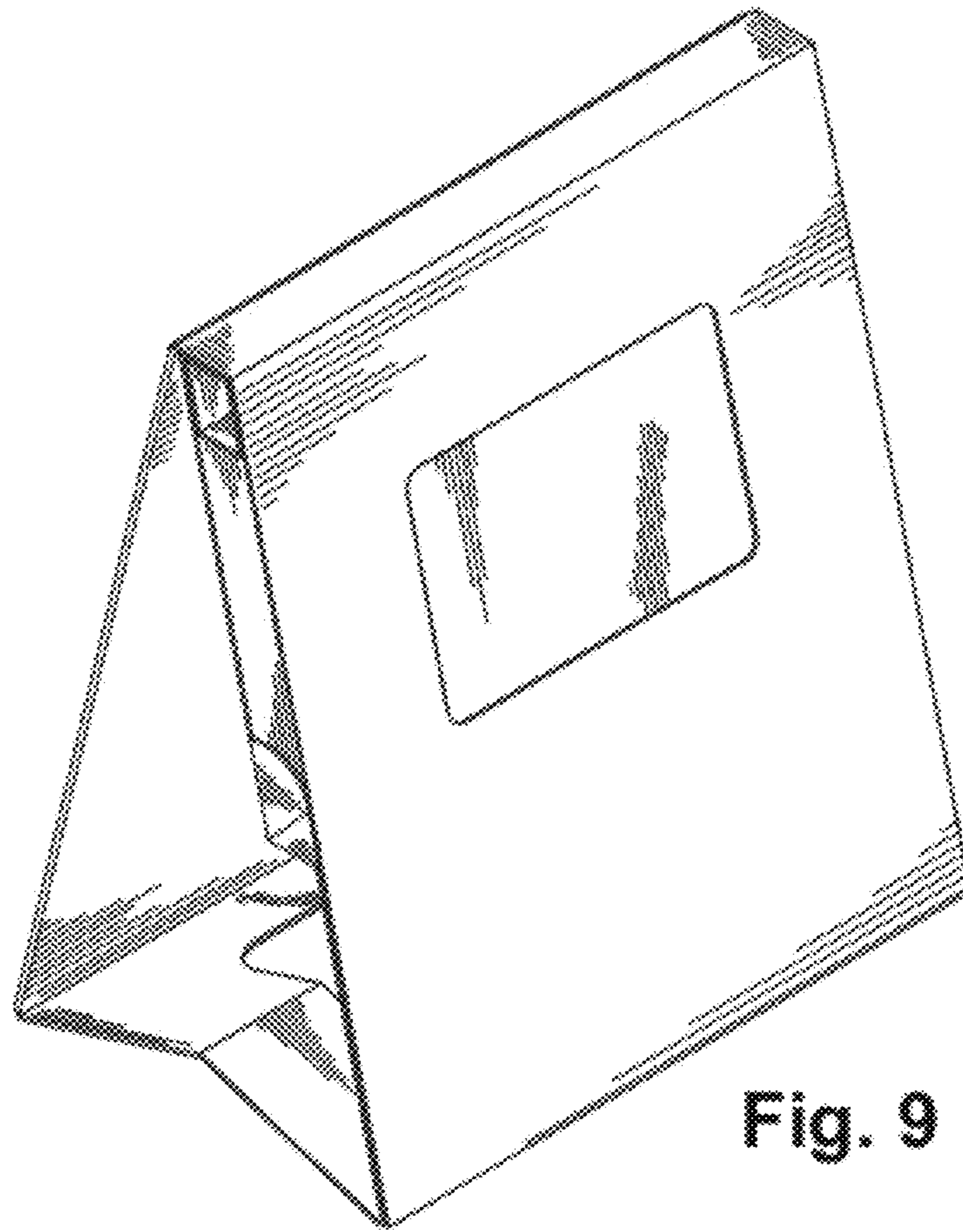

Fig. 9

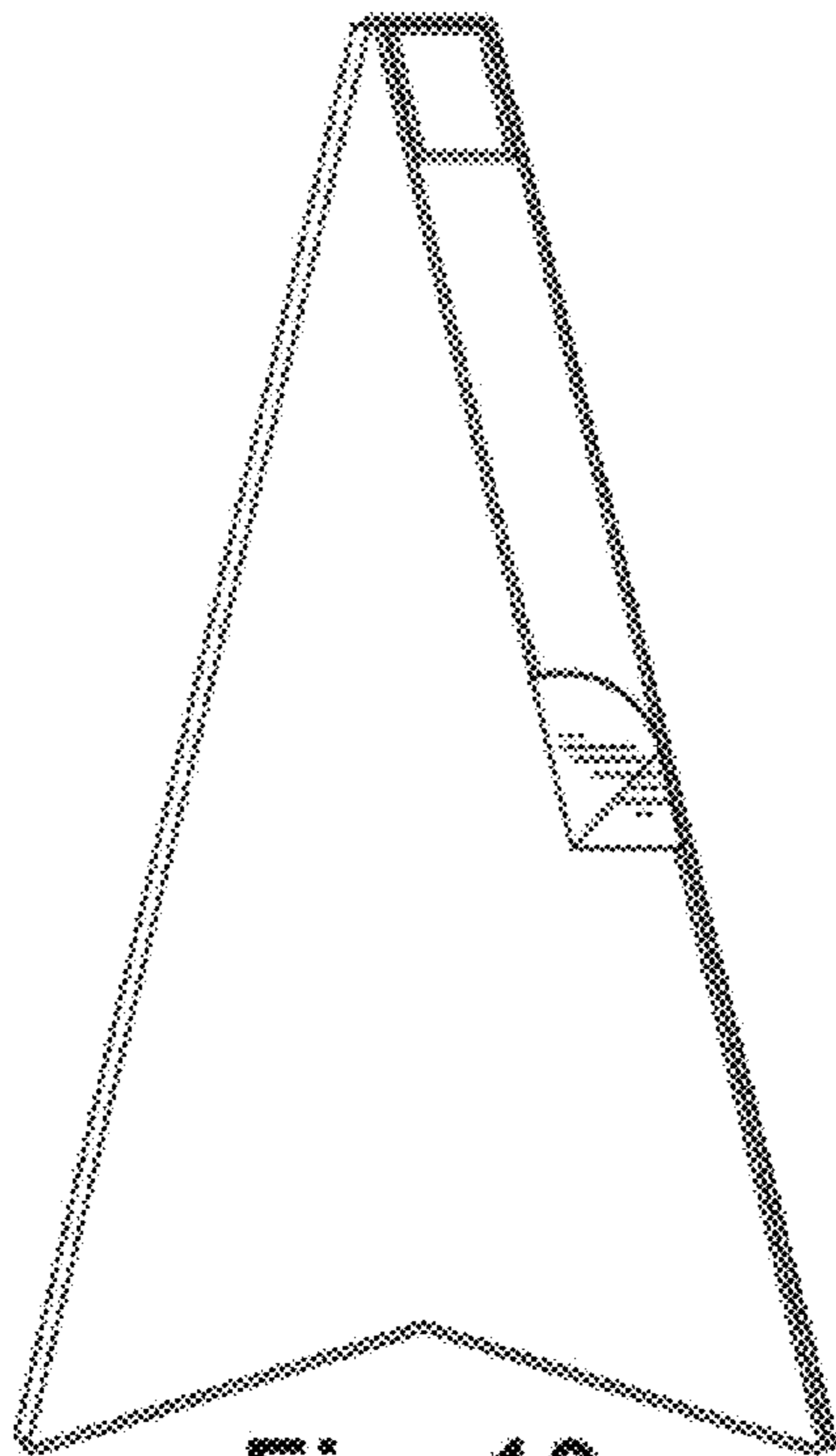

Fig. 10

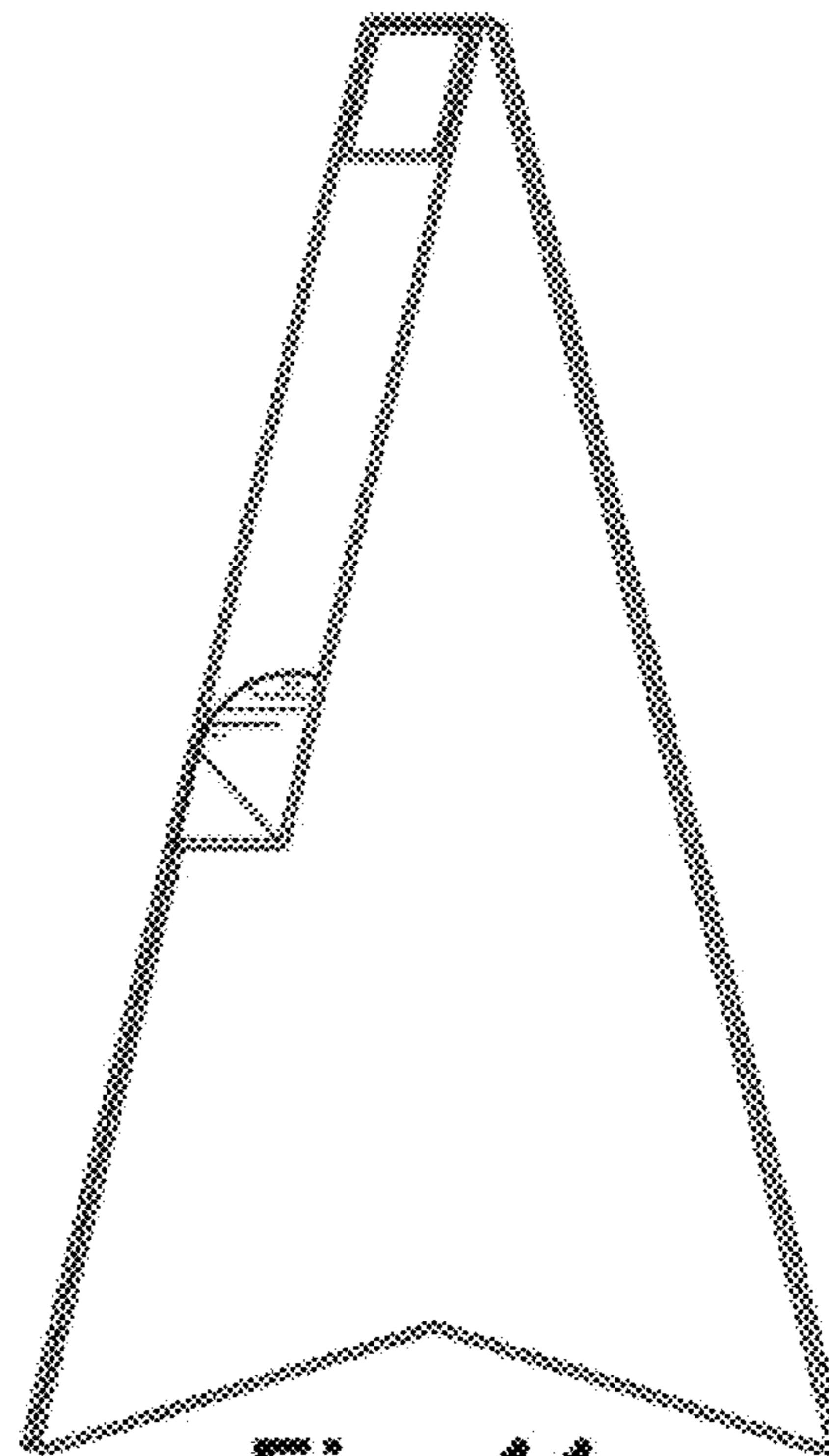

Fig. 11

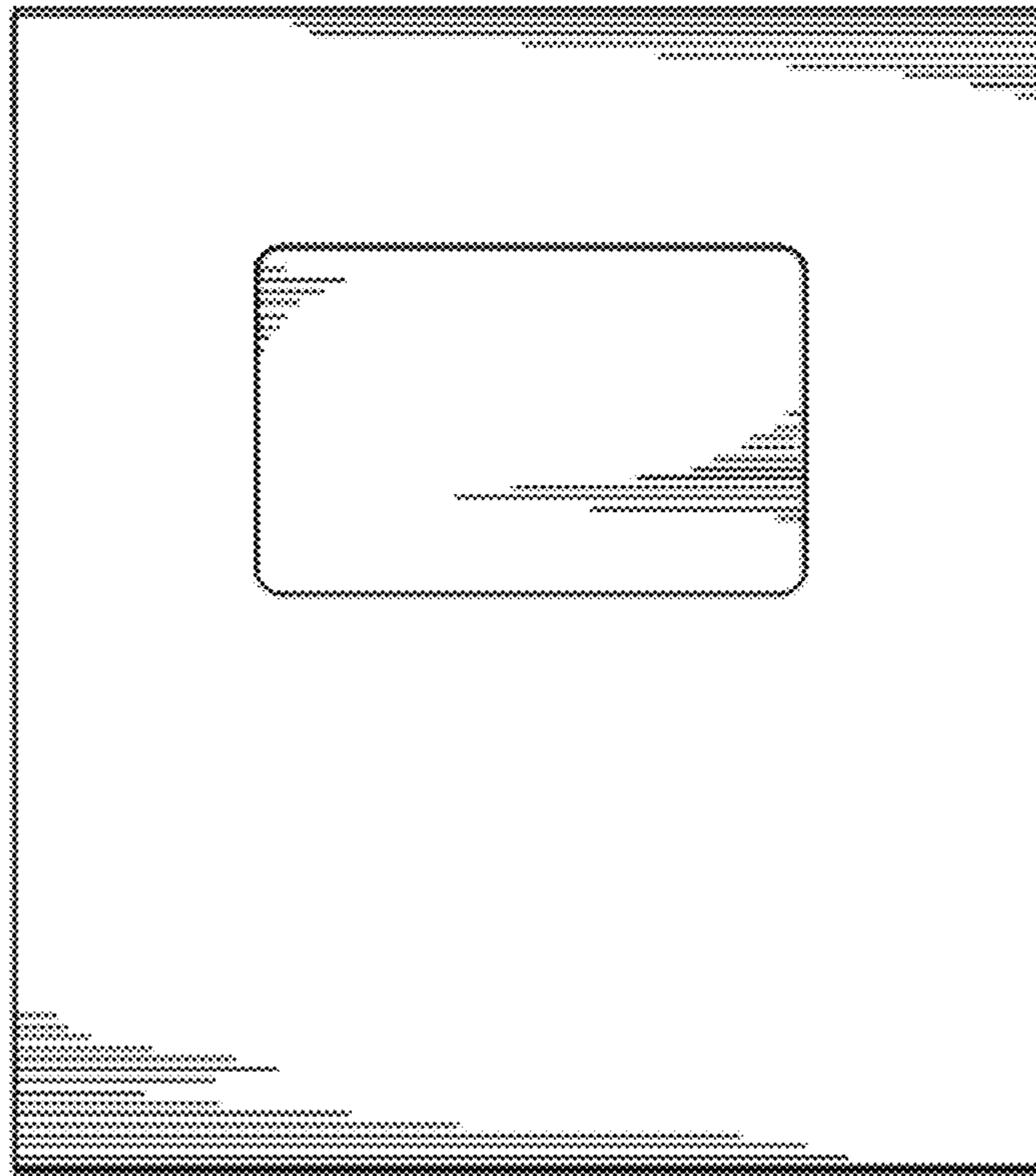

Fig. 12

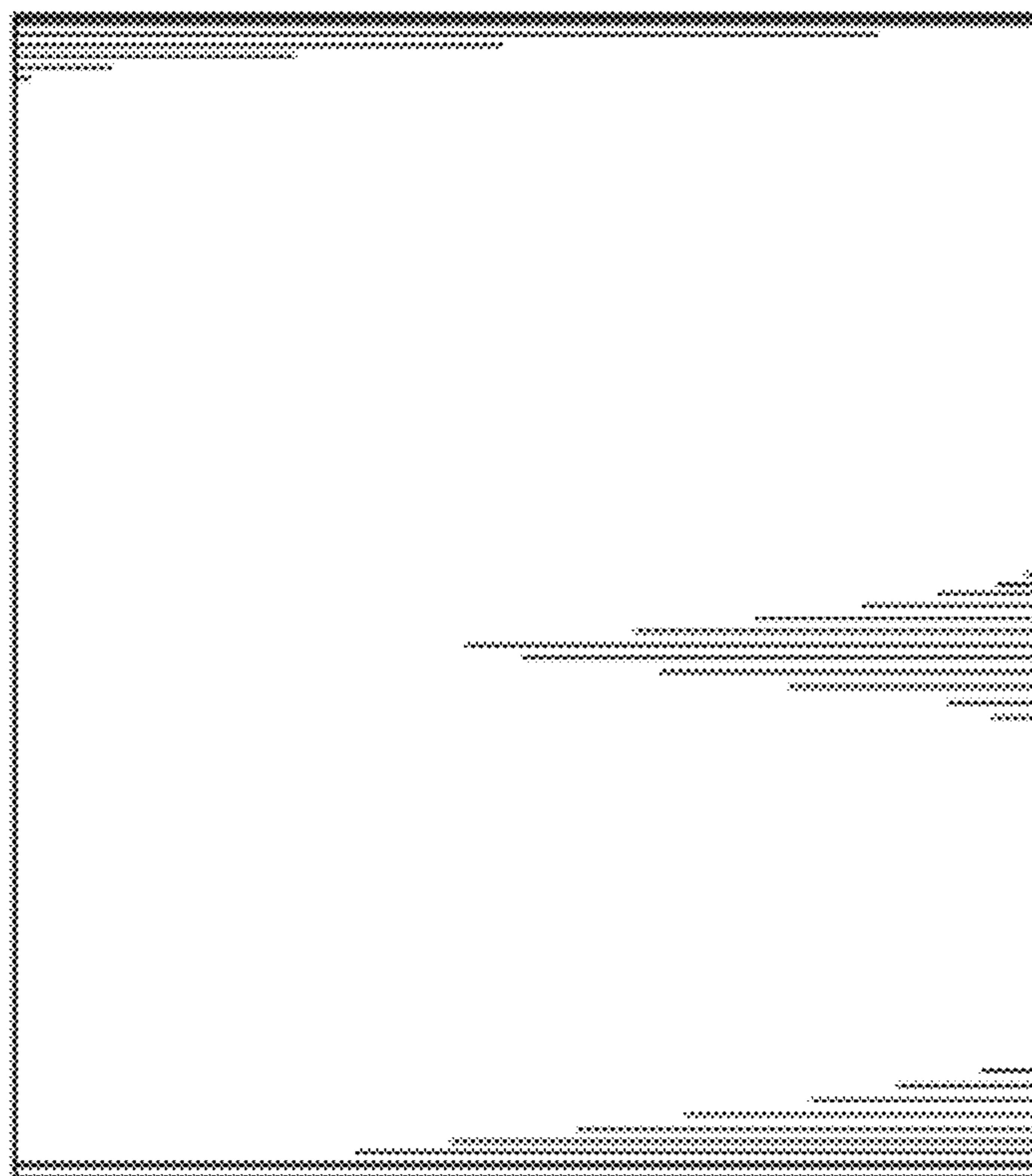

Fig. 13

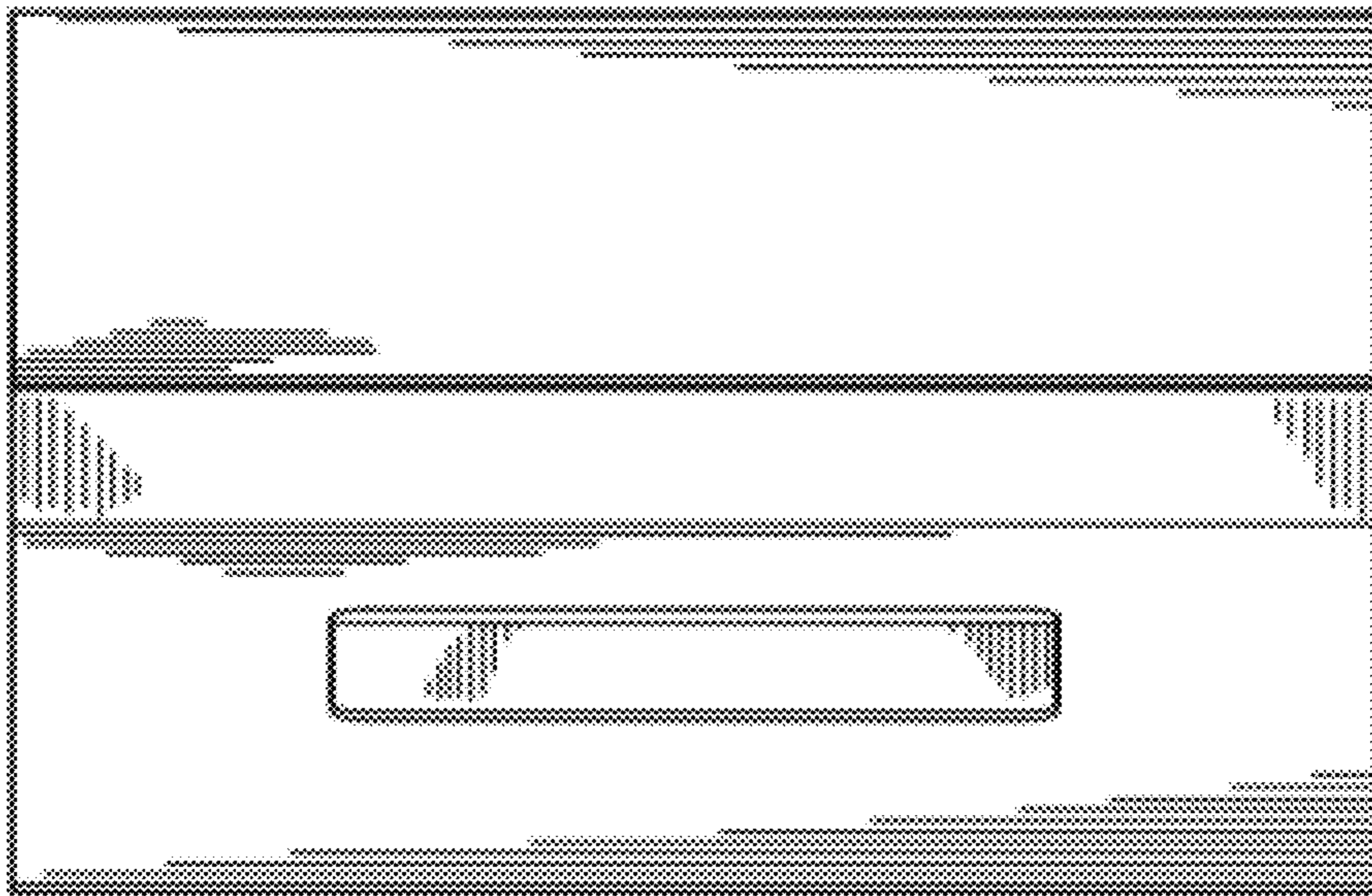

Fig. 14

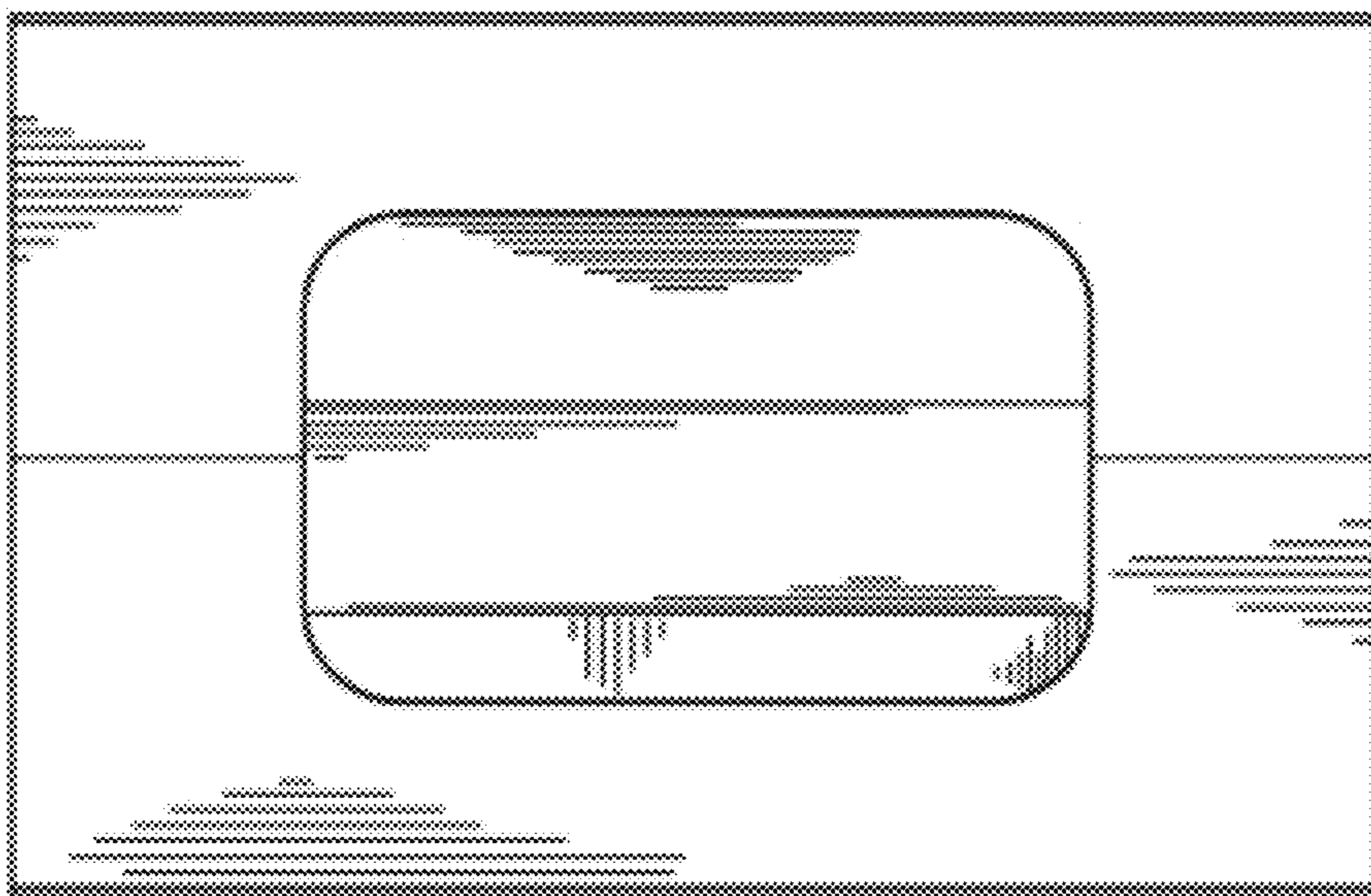

Fig. 15