



US00D665419S

(12) **United States Design Patent**
Pizzutelli et al.

(10) **Patent No.:** **US D665,419 S**

(45) **Date of Patent:** **** Aug. 14, 2012**

(54) **DISPLAY SCREEN WITH ANIMATED GRAPHICAL USER INTERFACE**

(75) Inventors: **Antonio Pizzutelli**, Seattle, WA (US);
Craig Maitlen, Woodinville, WA (US);
John A. Solaro, Bellevue, WA (US)

(73) Assignee: **Microsoft Corporation**, Redmond, WA (US)

(**) Term: **14 Years**

(21) Appl. No.: **29/387,909**

(22) Filed: **Mar. 21, 2011**

(51) **LOC (9) Cl.** **32-00**

(52) **U.S. Cl.** **D14/492; D14/495**

(58) **Field of Classification Search** D14/485-495;
715/700-867, 973-977

See application file for complete search history.

(56) **References Cited**

U.S. PATENT DOCUMENTS

5,870,092	A *	2/1999	Bedford-Roberts	715/776
5,898,434	A *	4/1999	Small et al.	715/810
D469,442	S *	1/2003	Bohlen et al.	D14/485
D479,531	S *	9/2003	Yanagida	D14/486
6,880,132	B2 *	4/2005	Uemura	715/848
D519,515	S *	4/2006	Mugura	D14/485
D553,146	S *	10/2007	Byeon et al.	D14/486
7,386,799	B1 *	6/2008	Clanton et al.	715/758
7,479,949	B2 *	1/2009	Jobs et al.	345/173
7,543,245	B2 *	6/2009	Irimajiri	715/836
D622,283	S *	8/2010	Van Os	D14/486
7,988,553	B2 *	8/2011	Kastner et al.	463/29
2004/0100479	A1 *	5/2004	Nakano et al.	345/700

2009/0007017	A1 *	1/2009	Anzures et al.	715/835
2010/0023858	A1 *	1/2010	Ryu et al.	715/702
2010/0205541	A1 *	8/2010	Rapaport et al.	715/753

* cited by examiner

Primary Examiner — Karen E Kearney

(74) *Attorney, Agent, or Firm* — Banner & Witcoff, Ltd.

(57) **CLAIM**

The ornamental design for a display screen with animated graphical user interface, as shown and described.

DESCRIPTION

FIG. 1 is a front view of the first image in a sequence for a display screen with animated graphical user interface showing our new design;

FIG. 2 is the second image thereof;

FIG. 3 is the third image thereof;

FIG. 4 is the fourth image thereof;

FIG. 5 is the fifth image thereof;

FIG. 6 is the sixth image thereof;

FIG. 7 is the seventh image thereof;

FIG. 8 is the eighth image thereof;

FIG. 9 is the ninth image thereof;

FIG. 10 is the tenth image thereof;

FIG. 11 is the eleventh image thereof;

FIG. 12 is the twelfth image thereof;

FIG. 13 is the thirteenth image thereof;

FIG. 14 is the fourteenth image thereof; and,

FIG. 15 is the fifteenth image thereof.

The broken line showings of the remainder of the avatar and of the display screen are for environmental purposes only and form no part of the claimed design.

1 Claim, 15 Drawing Sheets

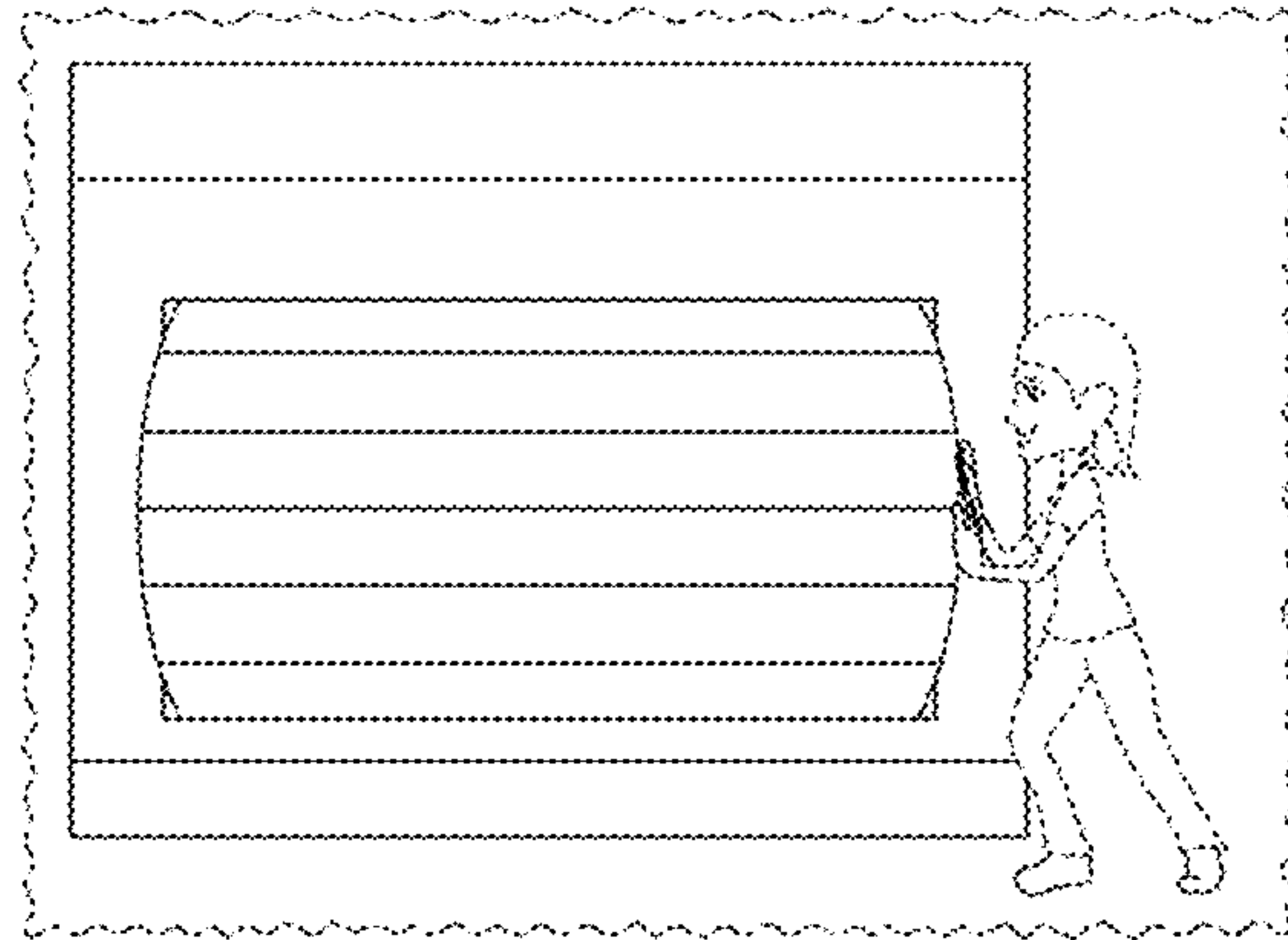
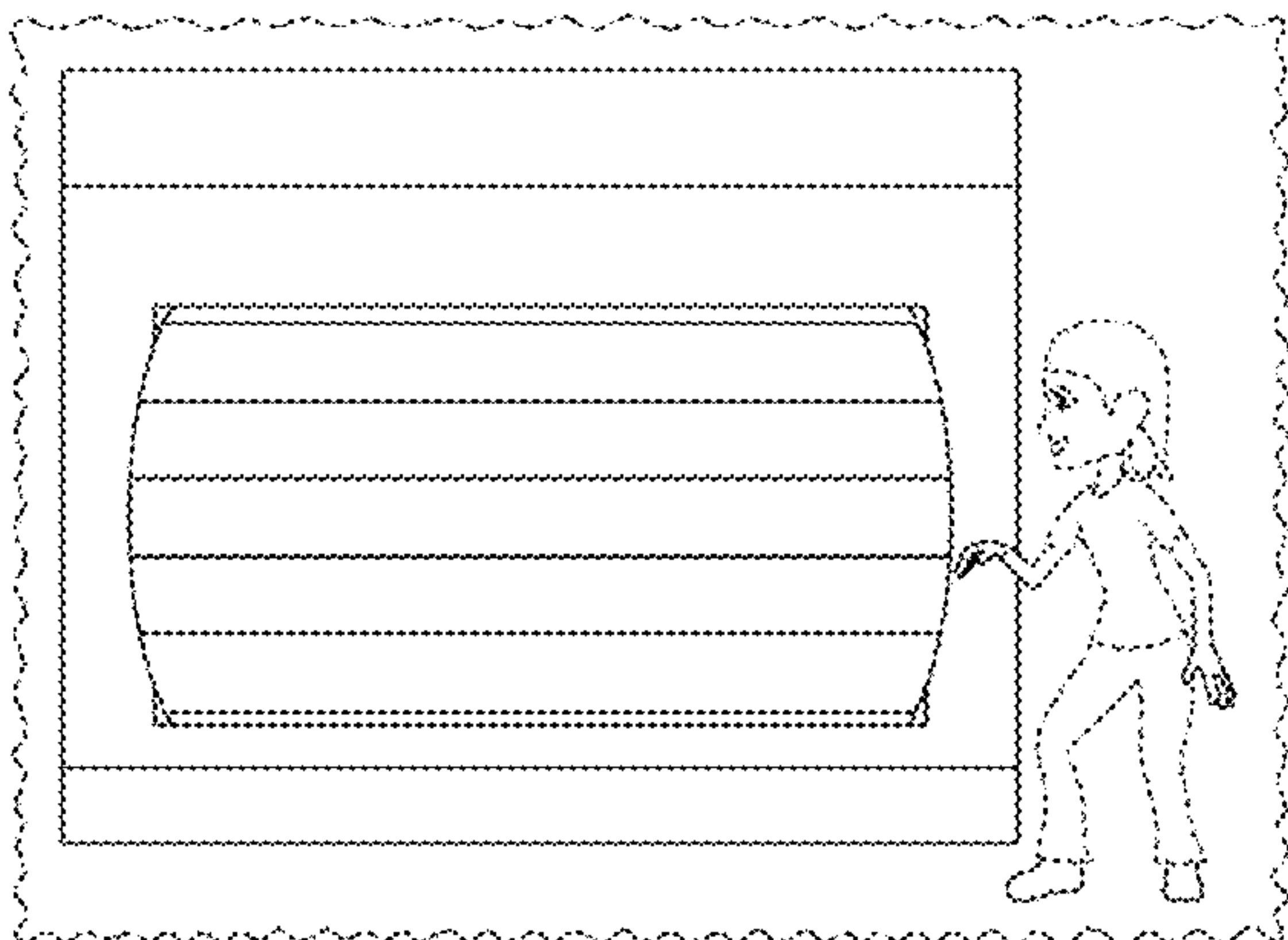

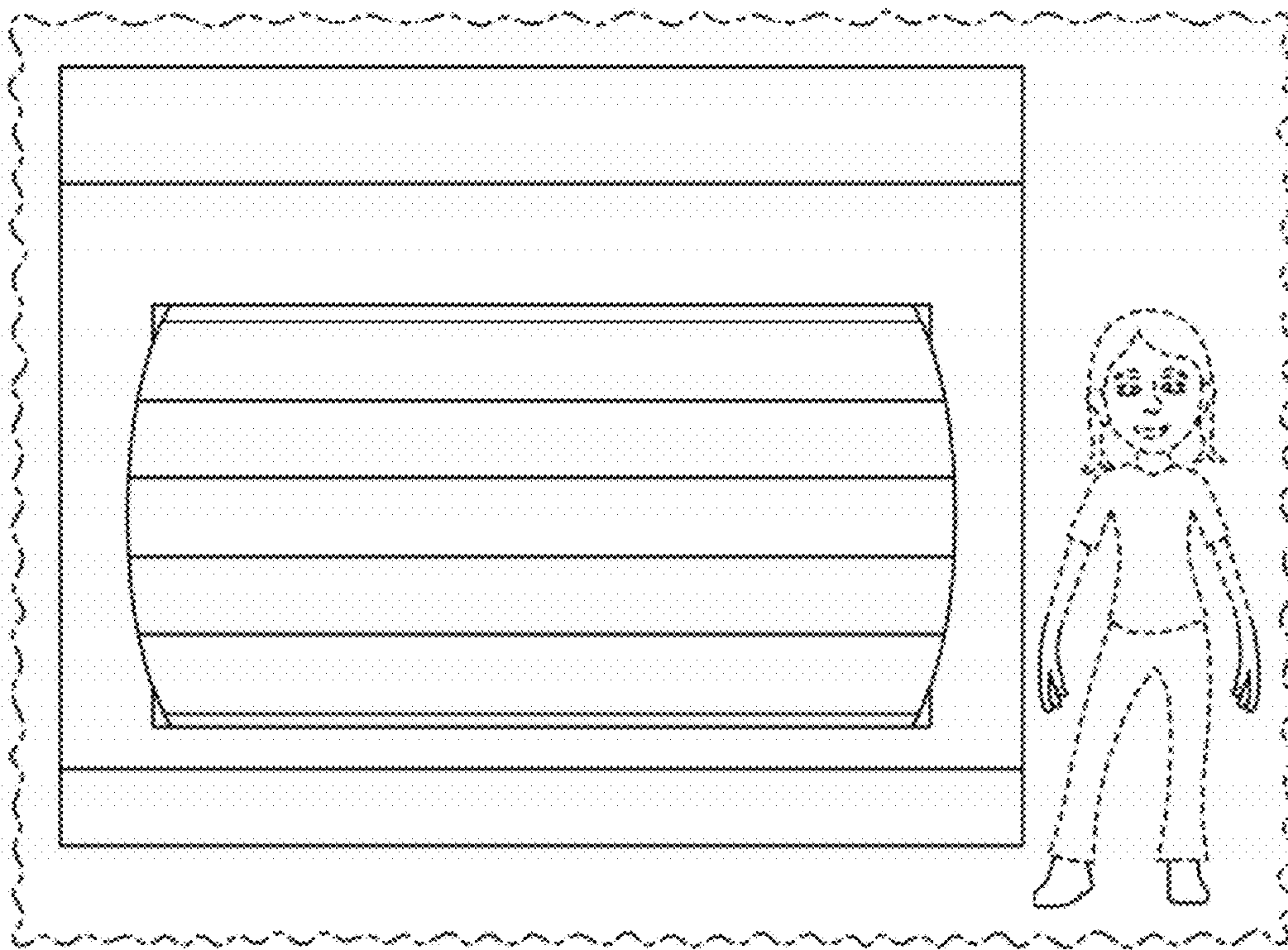

FIG. 1

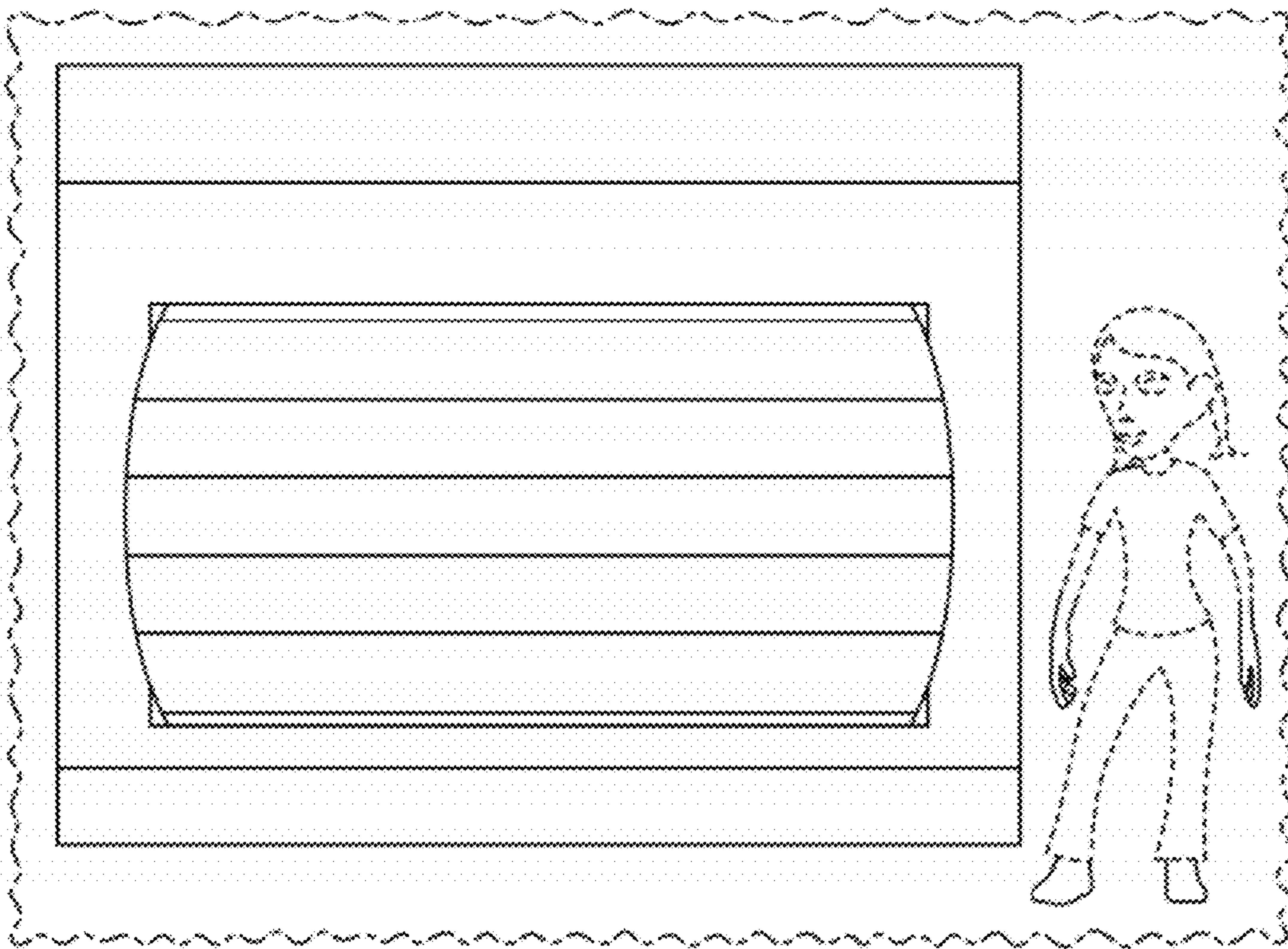

FIG. 2

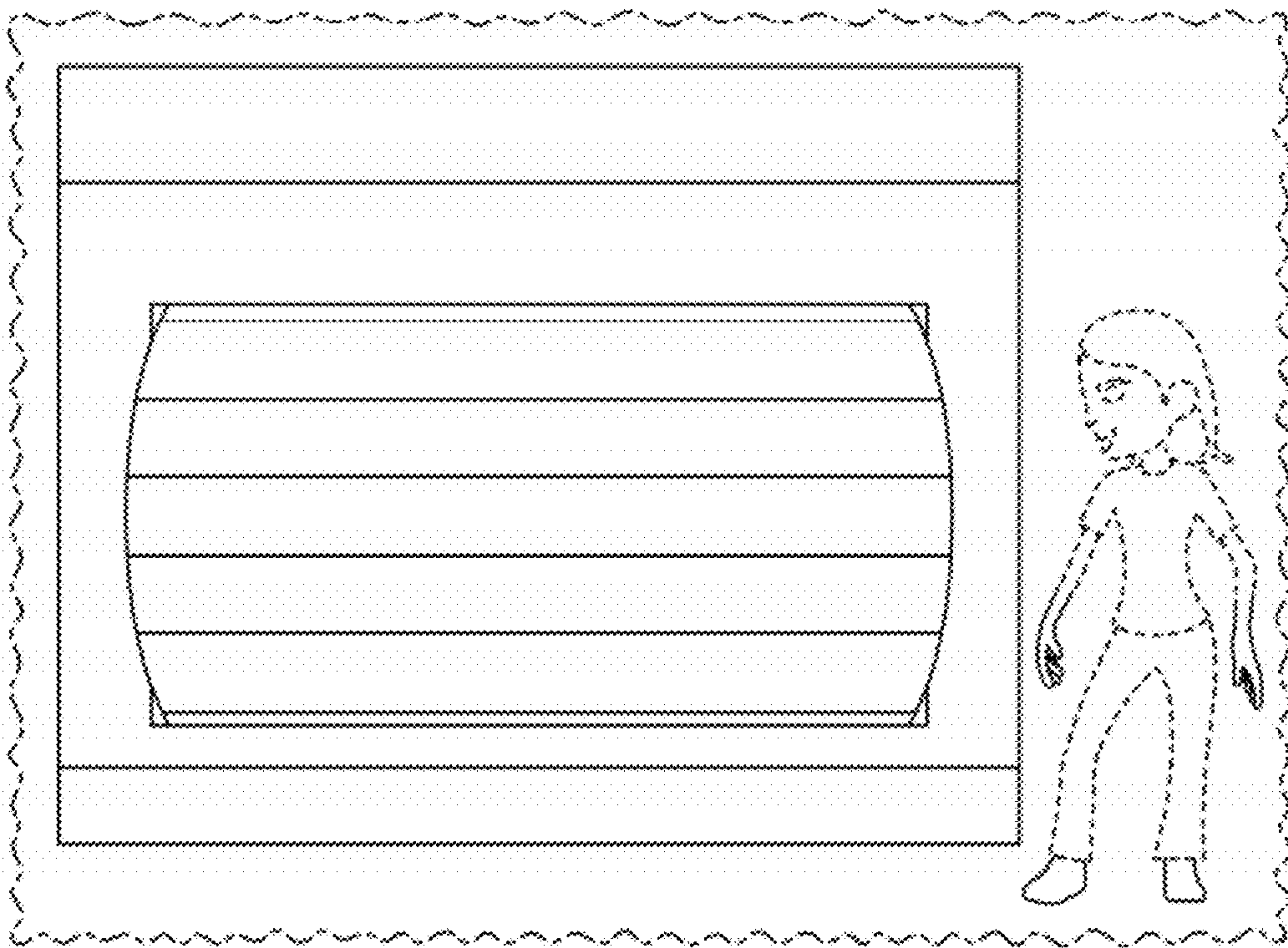

FIG. 3

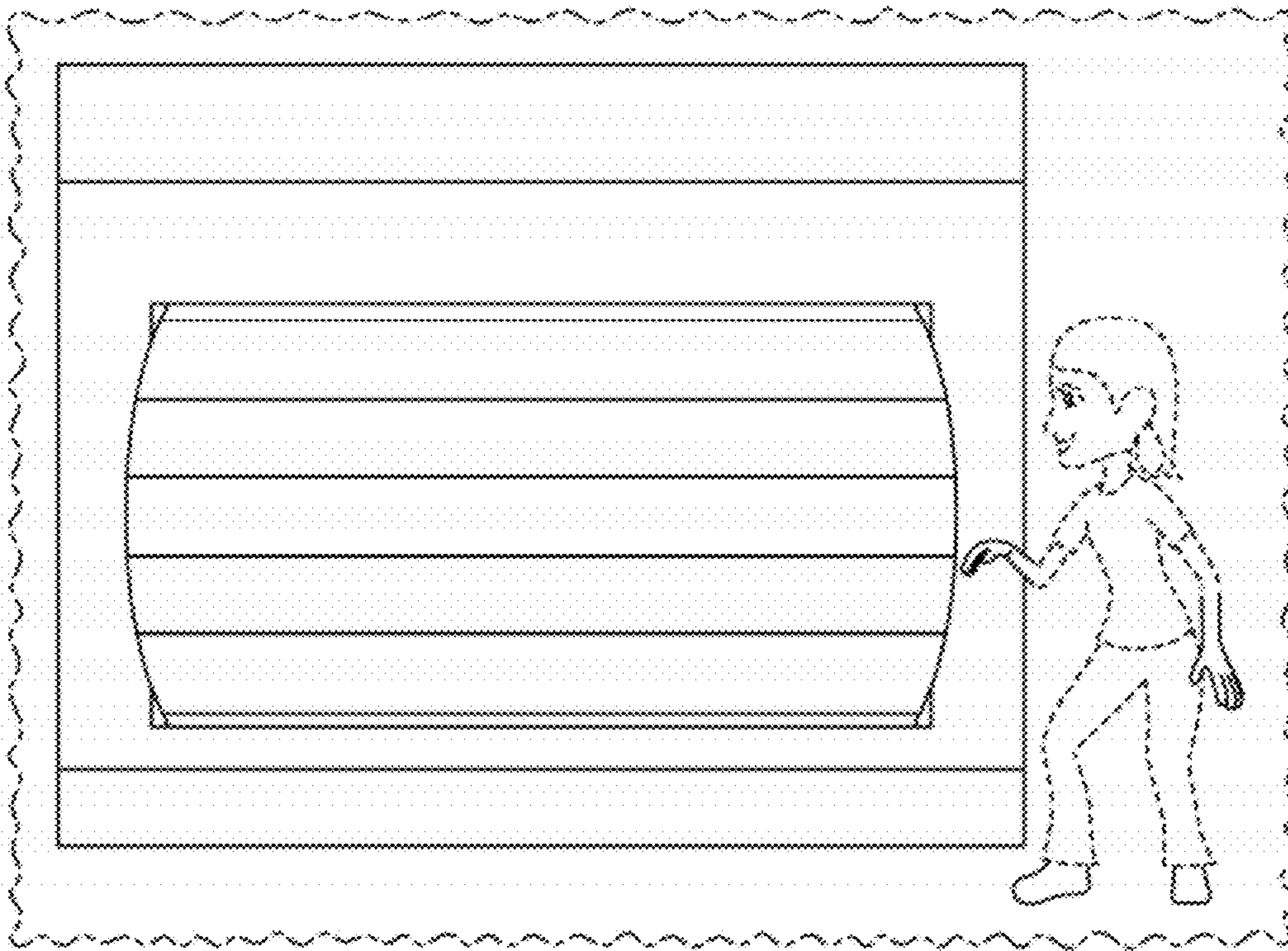

FIG. 4

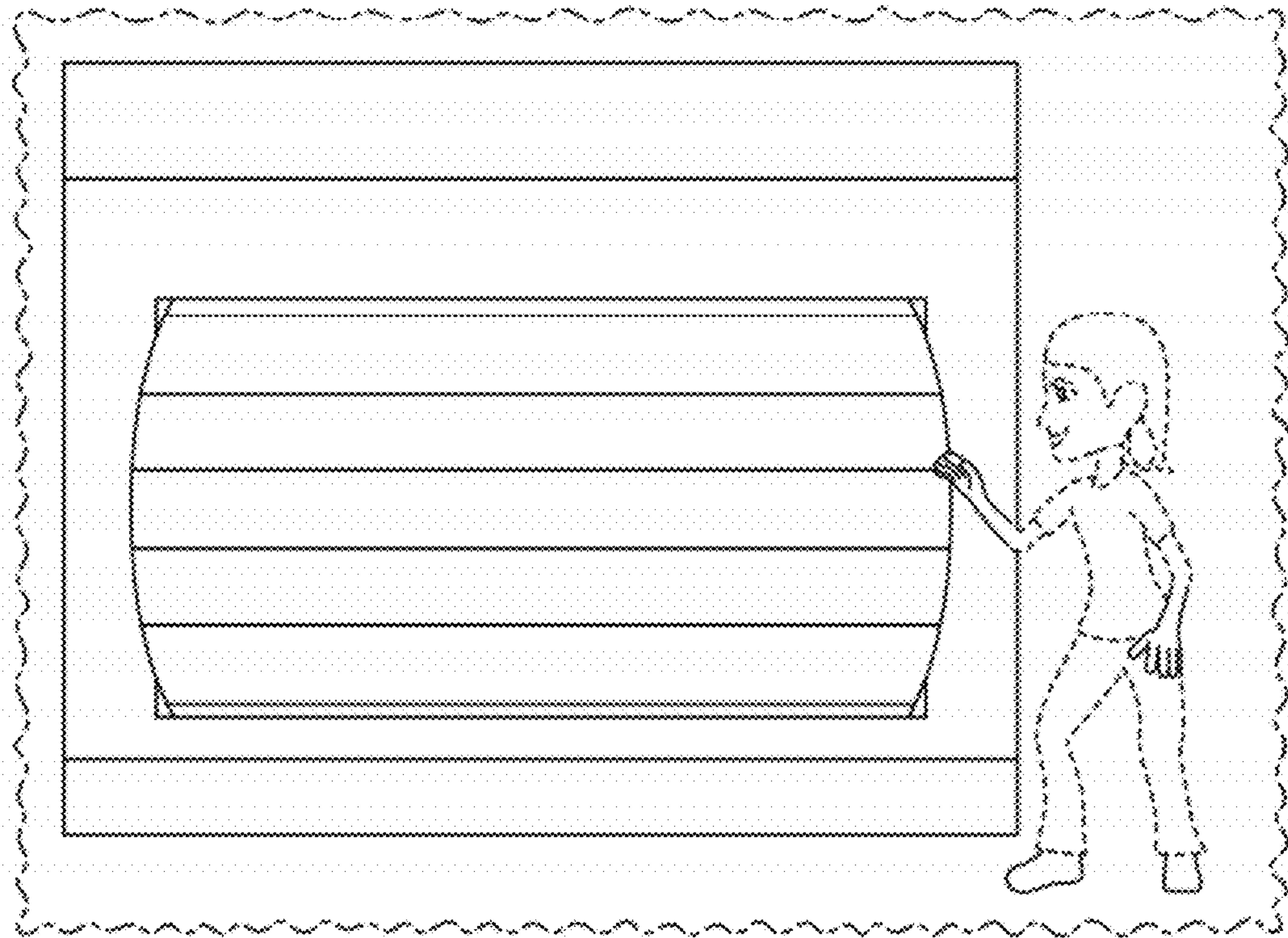

FIG. 5

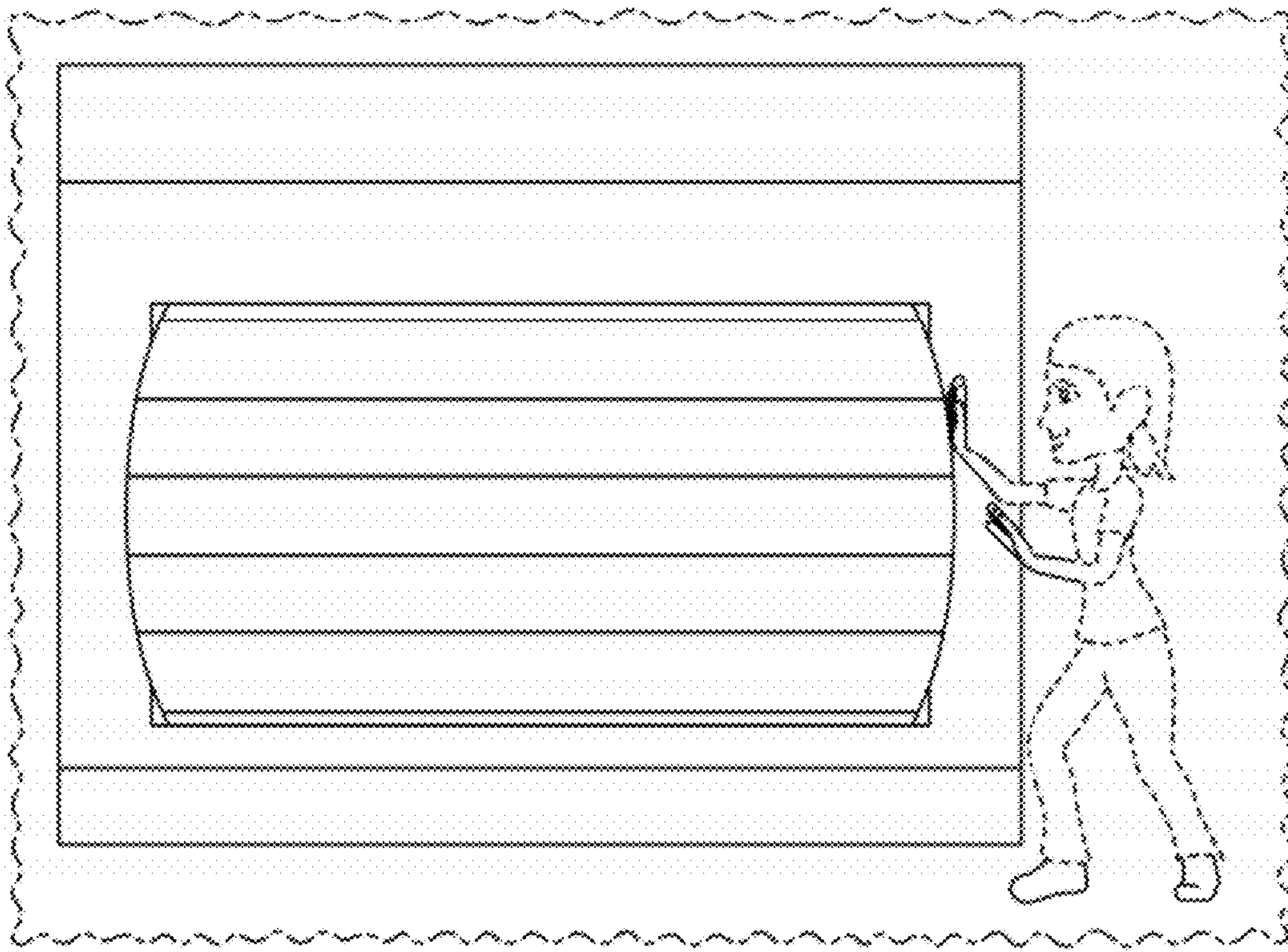

FIG. 6

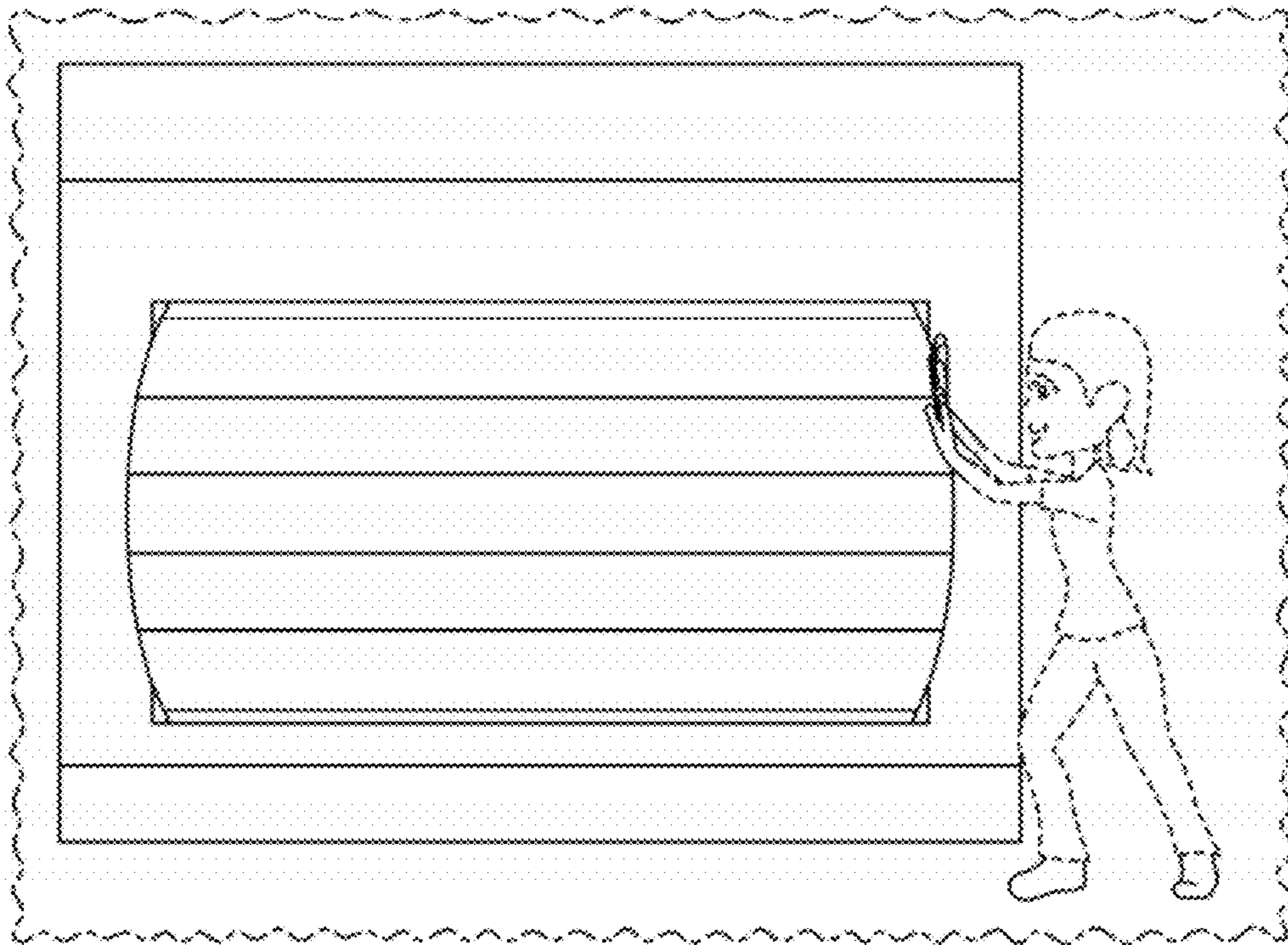

FIG. 7

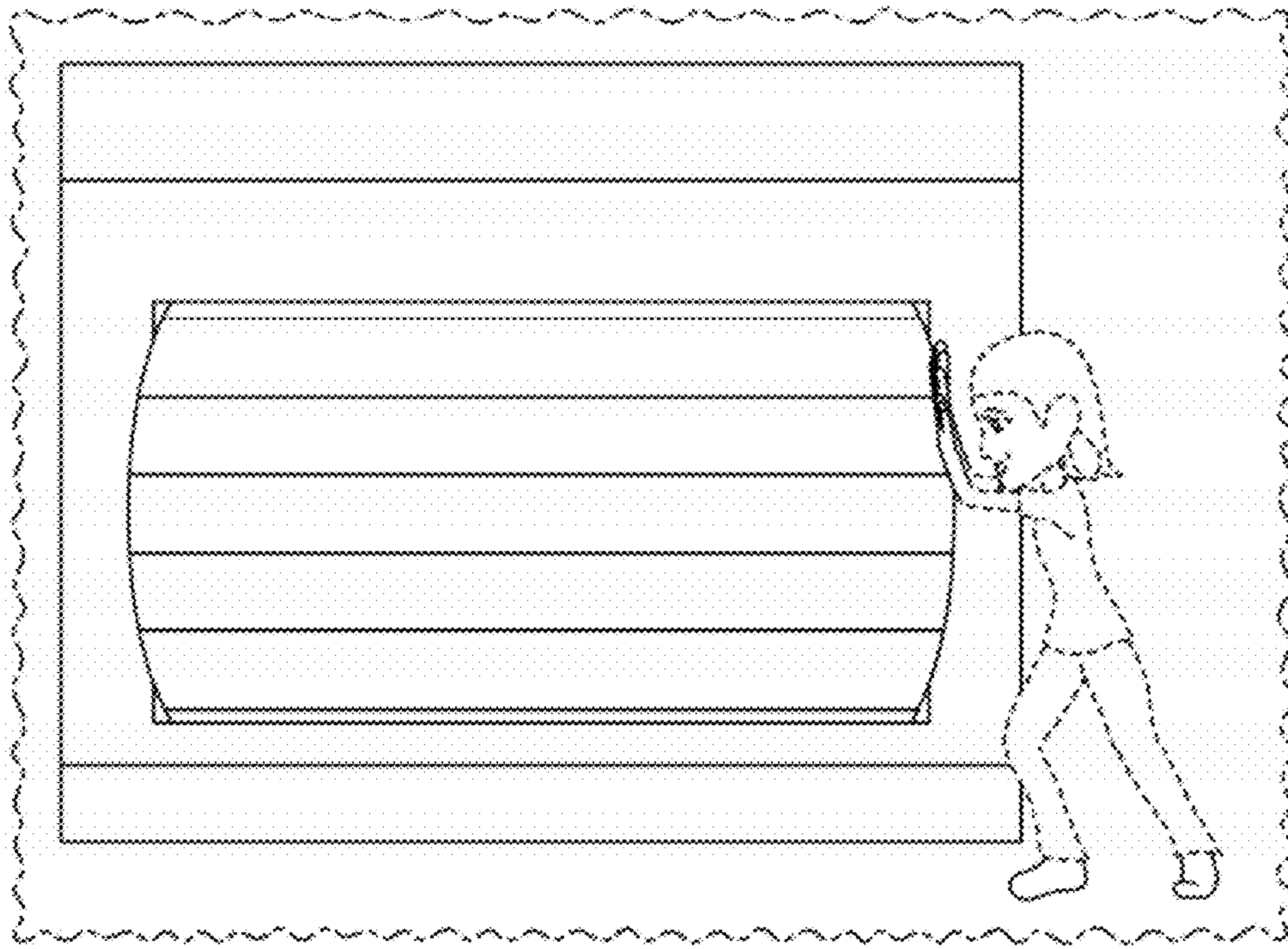

FIG. 8

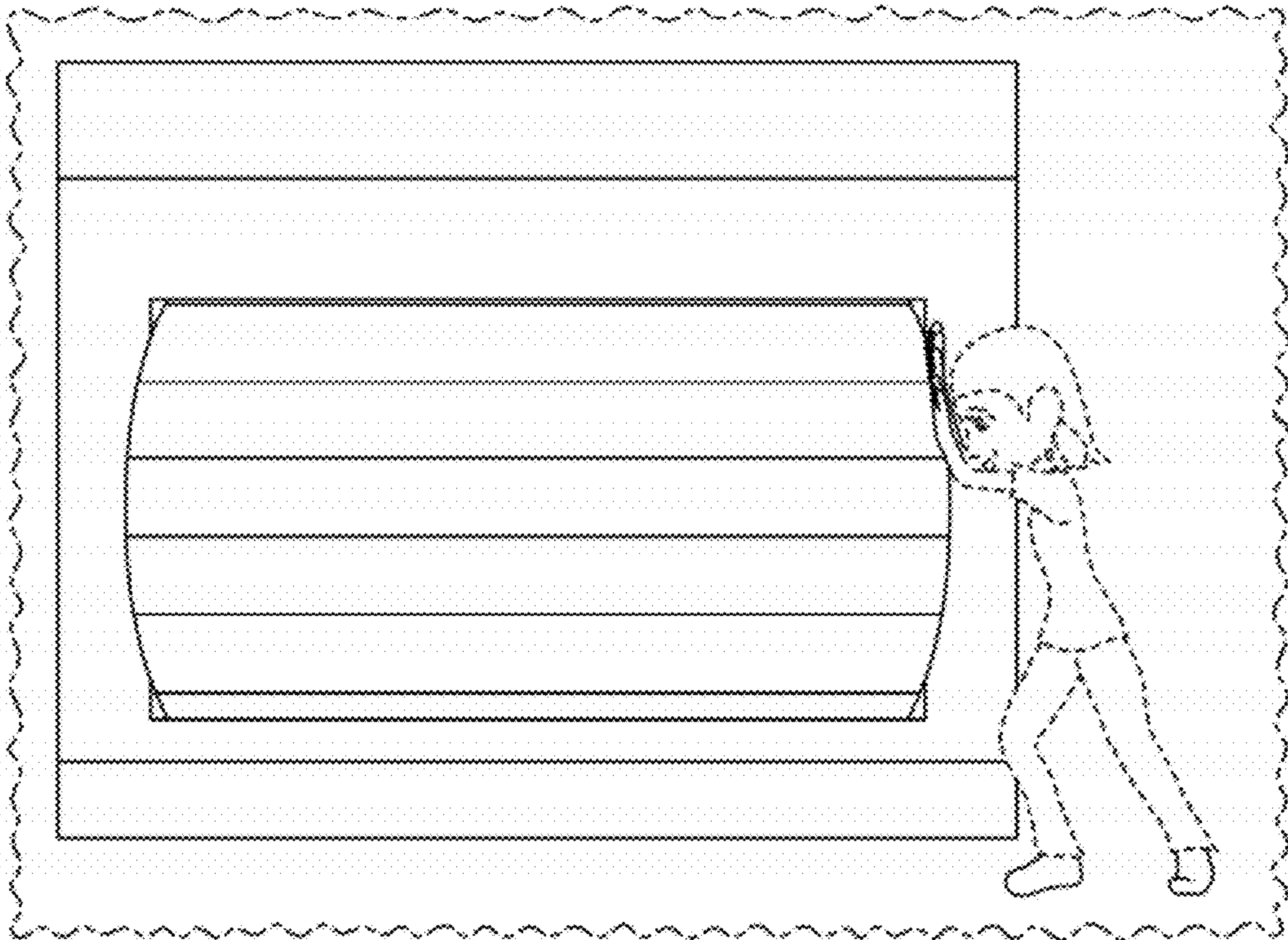

FIG. 9

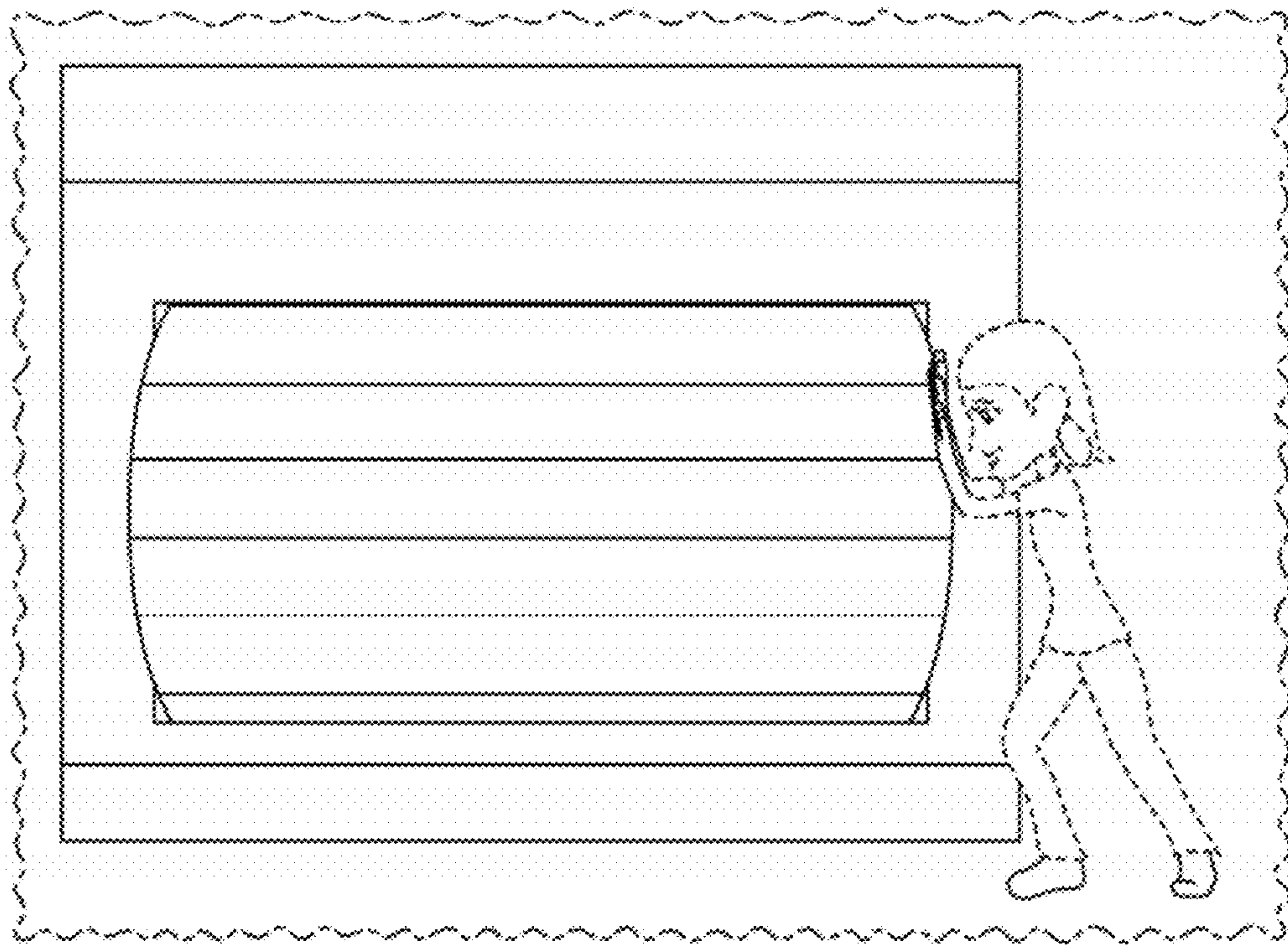

FIG. 10

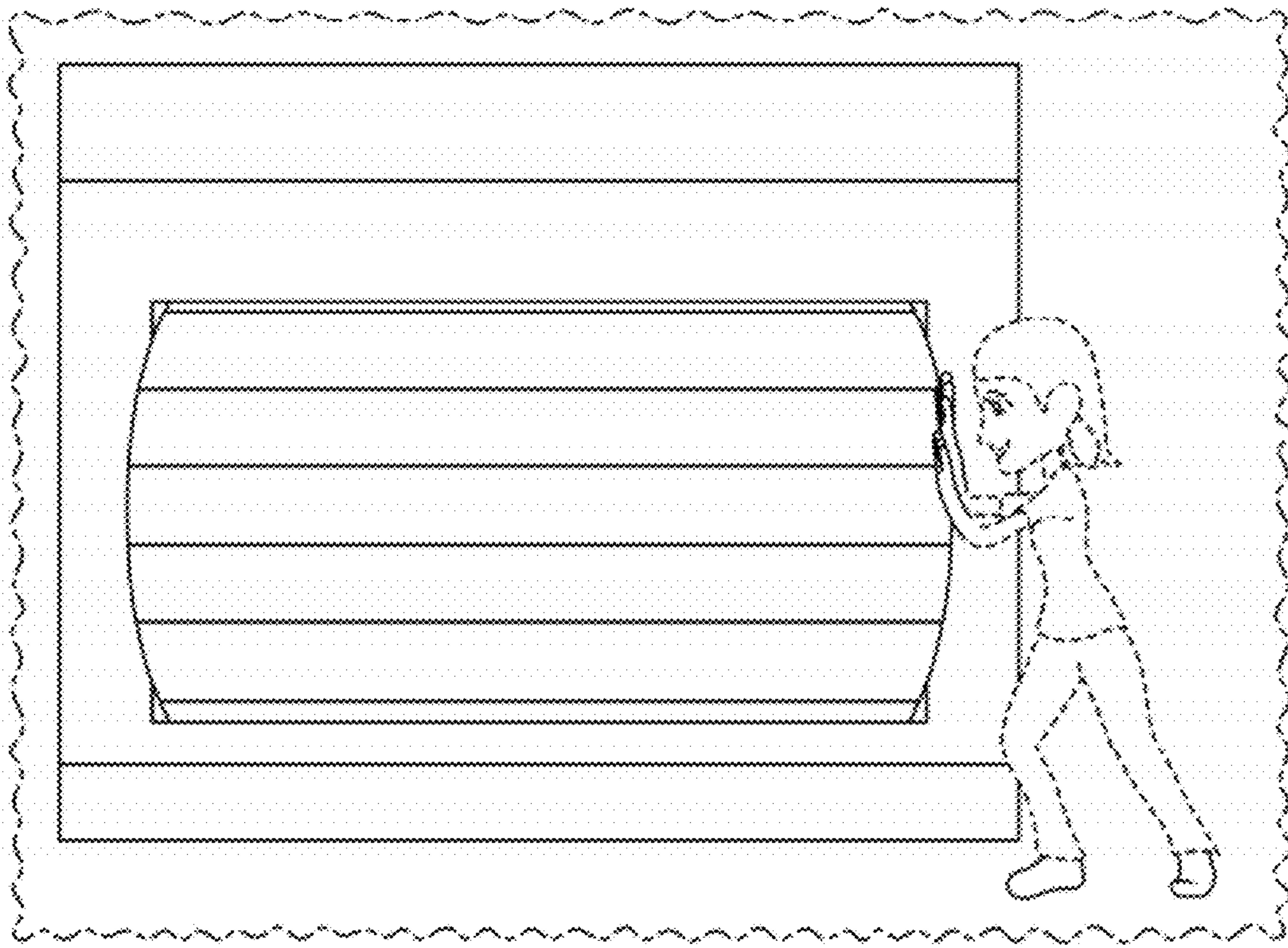

FIG. 11

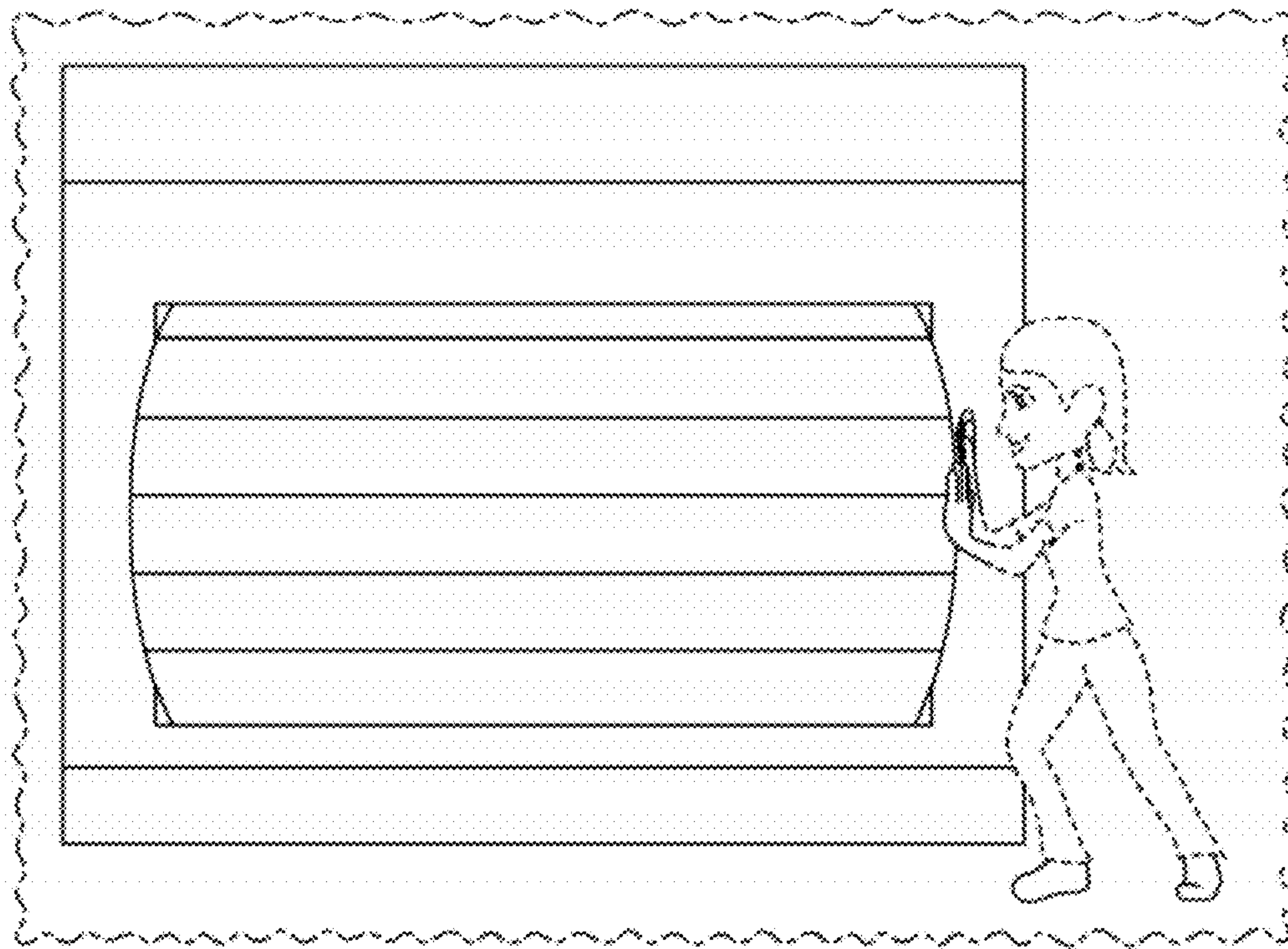

FIG. 12

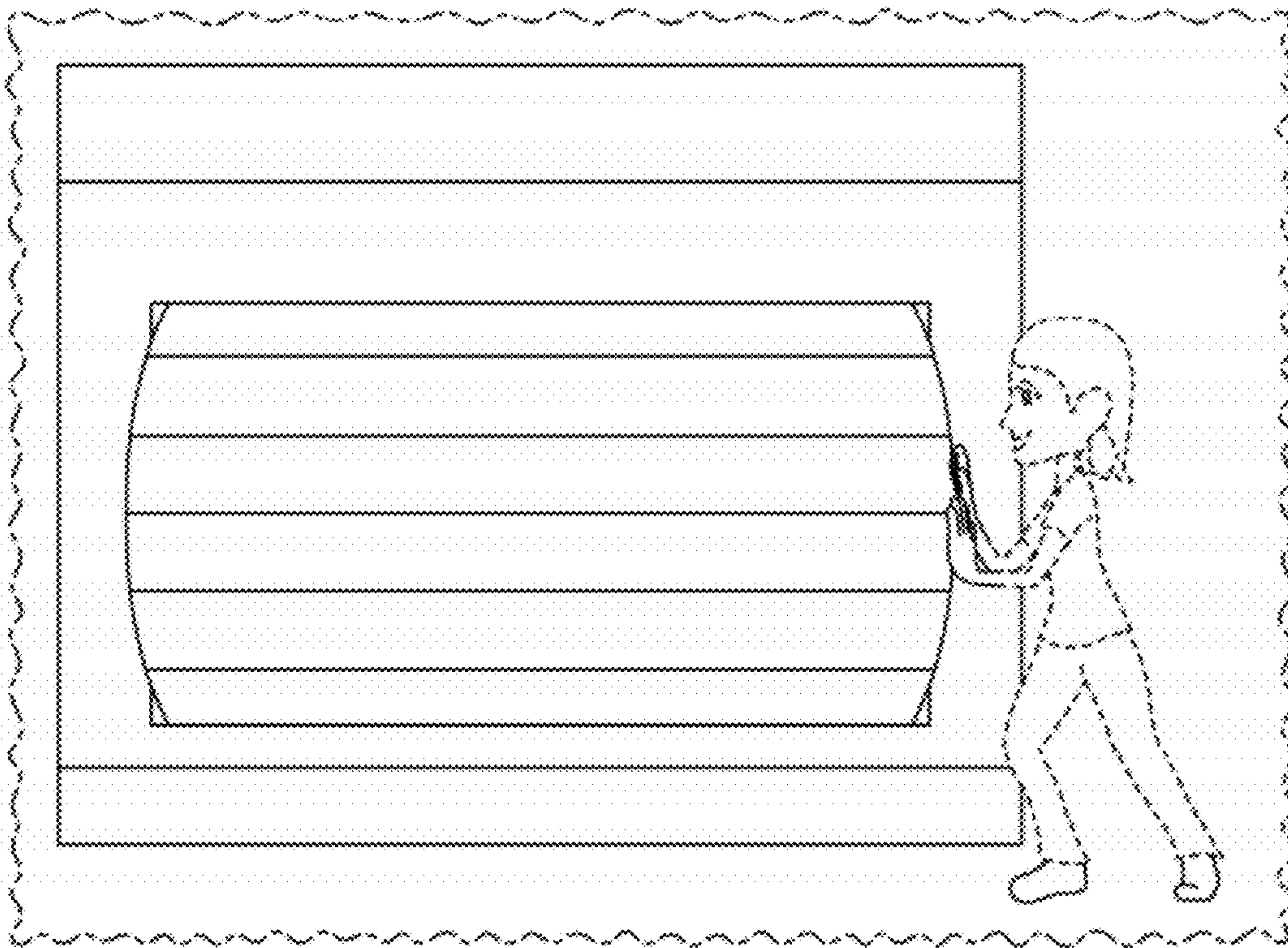

FIG. 13

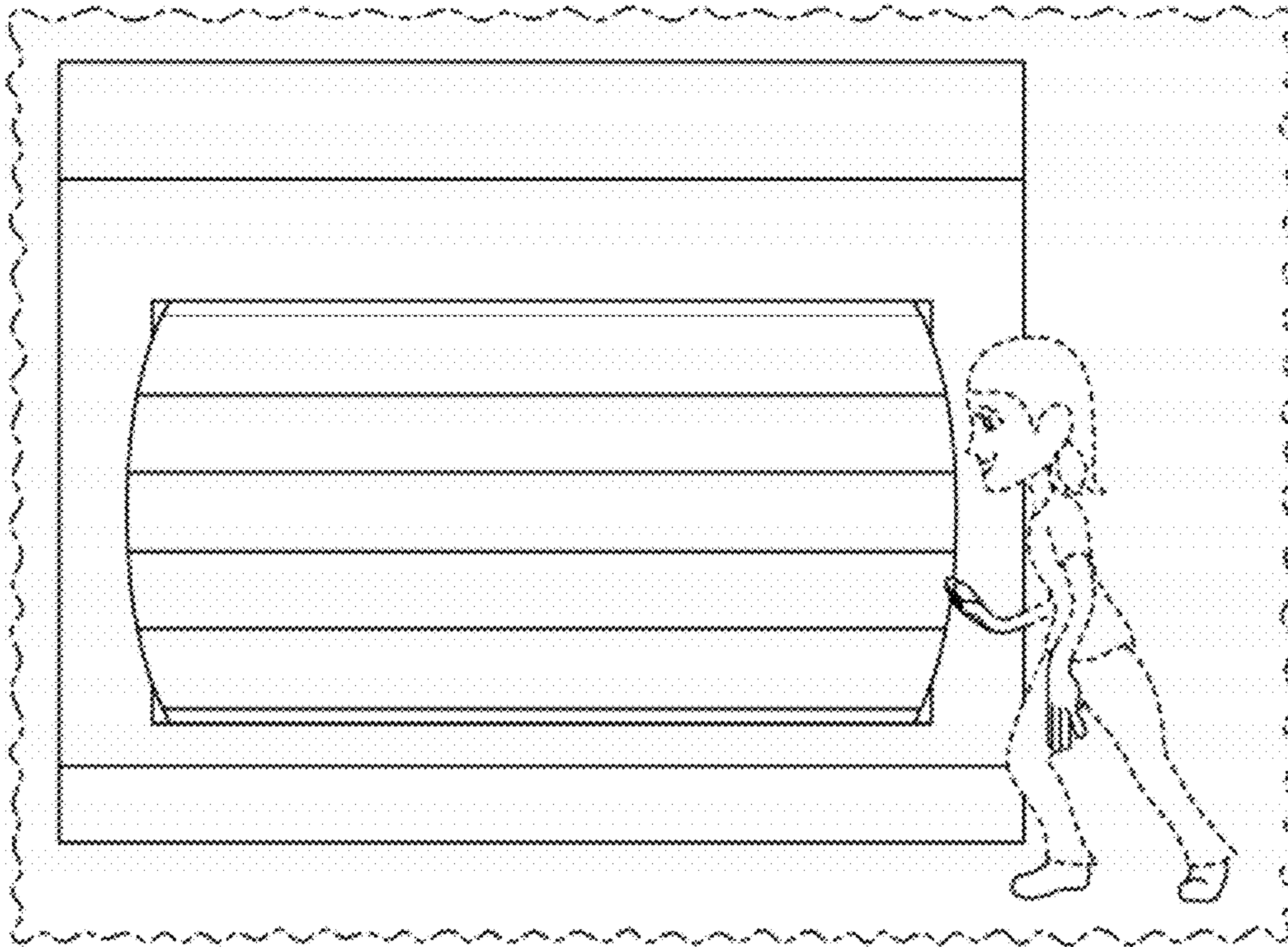

FIG. 14

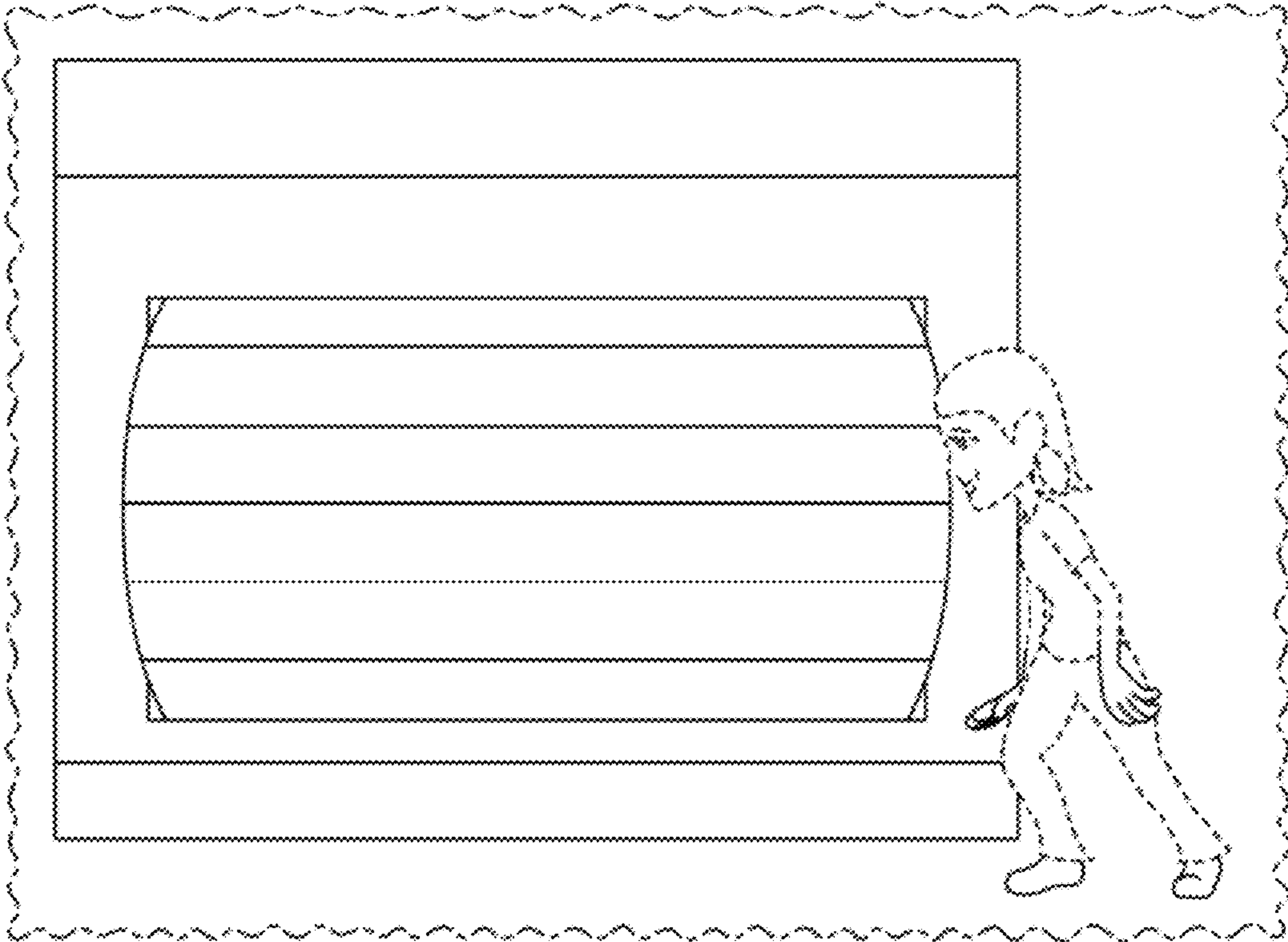

FIG. 15