

US00D665321S

(12) **United States Design Patent**  
**Huet**

(10) **Patent No.:** **US D665,321 S**

(45) **Date of Patent:** **\*\* Aug. 14, 2012**

(54) **DOOR FOR A VEHICLE**

(75) Inventor: **Nicolas Huet**, Munich (DE)

(73) Assignee: **Bayerische Motoren Werke Aktiengesellschaft**, Munich (DE)

(\*\*) Term: **14 Years**

(21) Appl. No.: **29/392,865**

(22) Filed: **May 27, 2011**

(30) **Foreign Application Priority Data**

Nov. 29, 2010 (DE) ..... 402010006547

(51) **LOC (9) Cl.** ..... **12-16**

(52) **U.S. Cl.** ..... **D12/196**

(58) **Field of Classification Search** ..... D12/196,  
D12/90-92, 86; 296/181.1, 181.5

See application file for complete search history.

(56) **References Cited**

**U.S. PATENT DOCUMENTS**

D558,113 S *	12/2007	Leclercq	.....	D12/196
D583,288 S *	12/2008	Leclercq	.....	D12/196
D593,471 S *	6/2009	Larson	.....	D12/196
D598,355 S *	8/2009	Sato et al.	.....	D12/196
D617,706 S *	6/2010	Lamm et al.	.....	D12/196
D617,707 S *	6/2010	Lamm et al.	.....	D12/196
D637,112 S *	5/2011	Saracoglu	.....	D12/92

\* cited by examiner

*Primary Examiner* — Melody N Brown

(74) *Attorney, Agent, or Firm* — Crowell & Moring LLP

(57) **CLAIM**

The ornamental design for a door for a vehicle, as shown and described.

**DESCRIPTION**

This application contains subject matter related to the following co-pending U.S. design patent application: Application Ser. No. 29/392,863, filed herewith and entitled "Vehicle, Toy, and/or Replicas Thereof".

FIG. 1 is a left perspective view of a embodiment of a door for a vehicle according to my design;

FIG. 2 is a right perspective view thereof;

FIG. 3 is a front view thereof;

FIG. 4 is a left side view thereof;

FIG. 5 is a right side view thereof;

FIG. 6 is a top view thereof; and

FIG. 7 is a bottom view thereof.

FIG. 8 is a right perspective view of a second embodiment of the door for a vehicle according to my design;

FIG. 9 is a left perspective view of FIG. 8;

FIG. 10 is a front view of FIG. 8;

FIG. 11 is a right side view of FIG. 8;

FIG. 12 is a left side view of FIG. 8;

FIG. 13 is a top view of FIG. 8; and,

FIG. 14 is a bottom view of FIG. 8.

The broken lines are for illustrative purposes only and form no part of the claimed design.

**1 Claim, 6 Drawing Sheets**

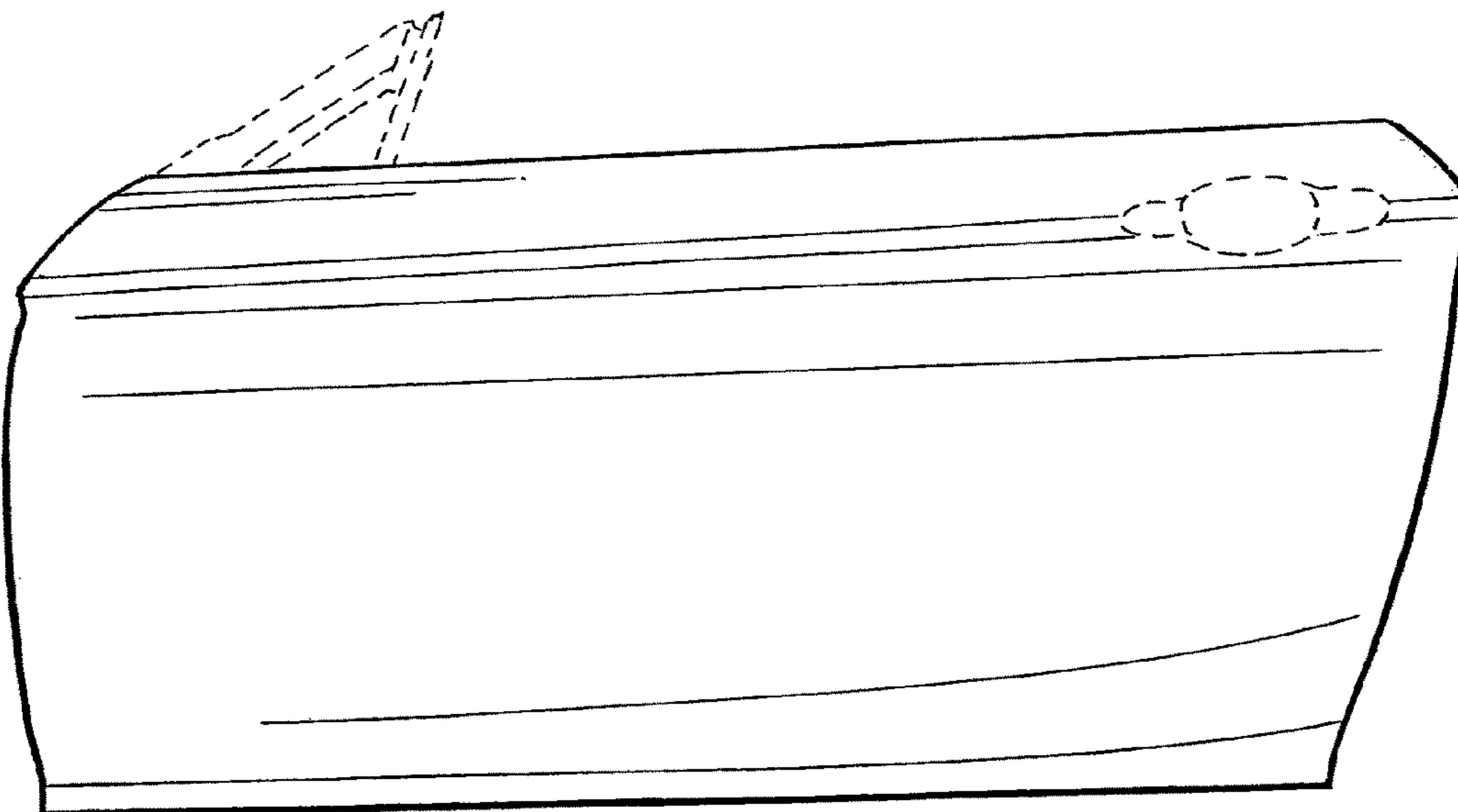

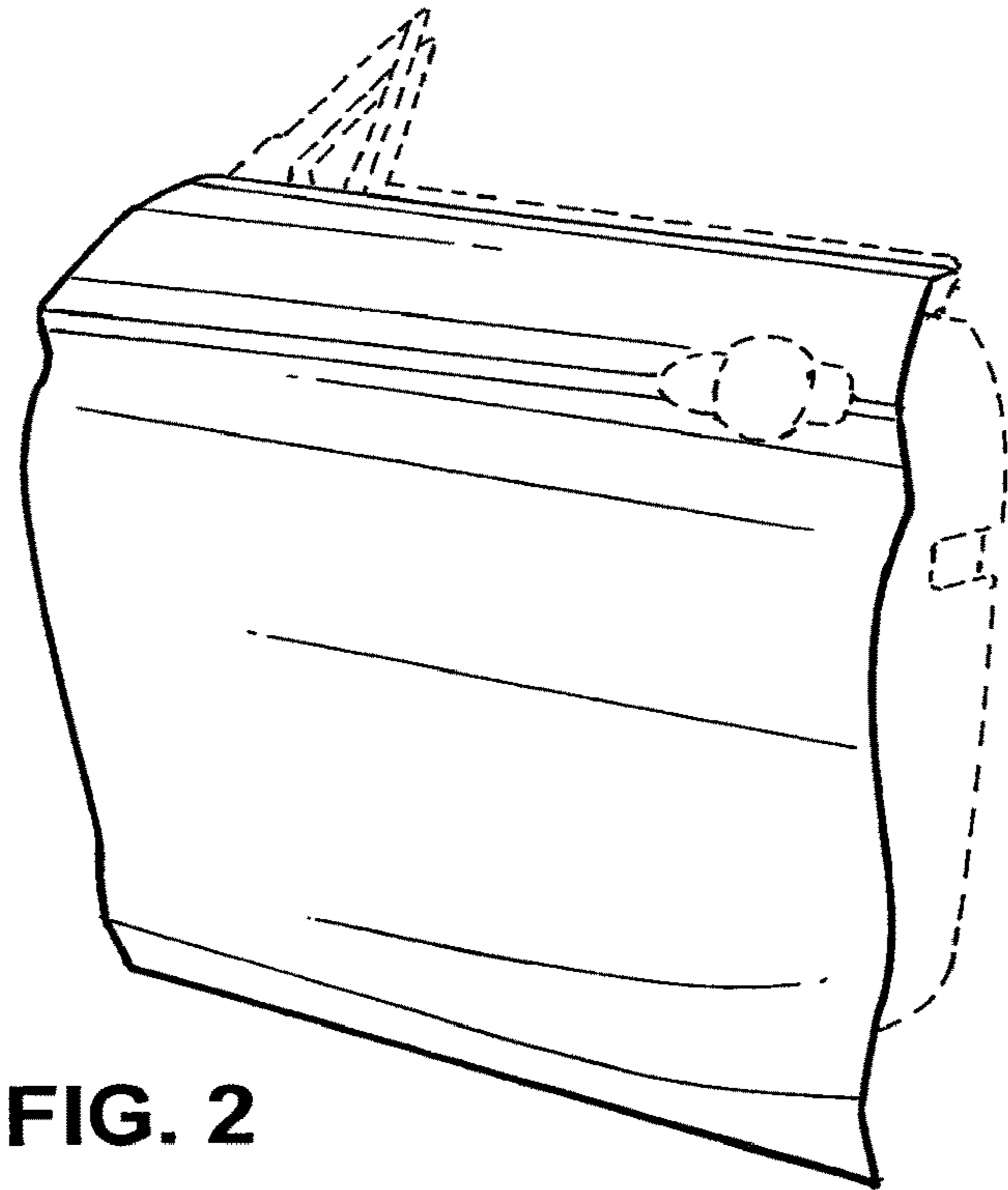
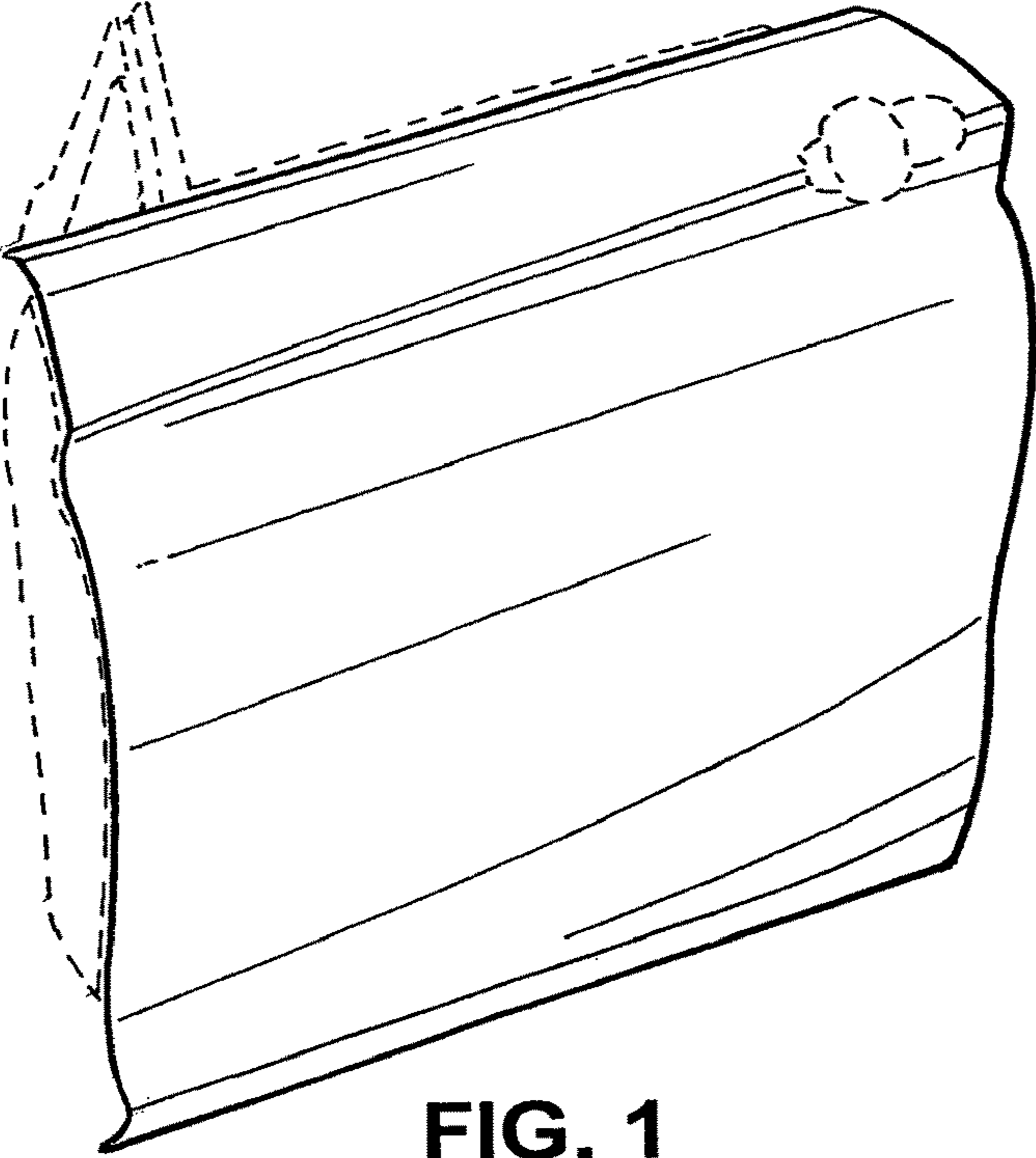

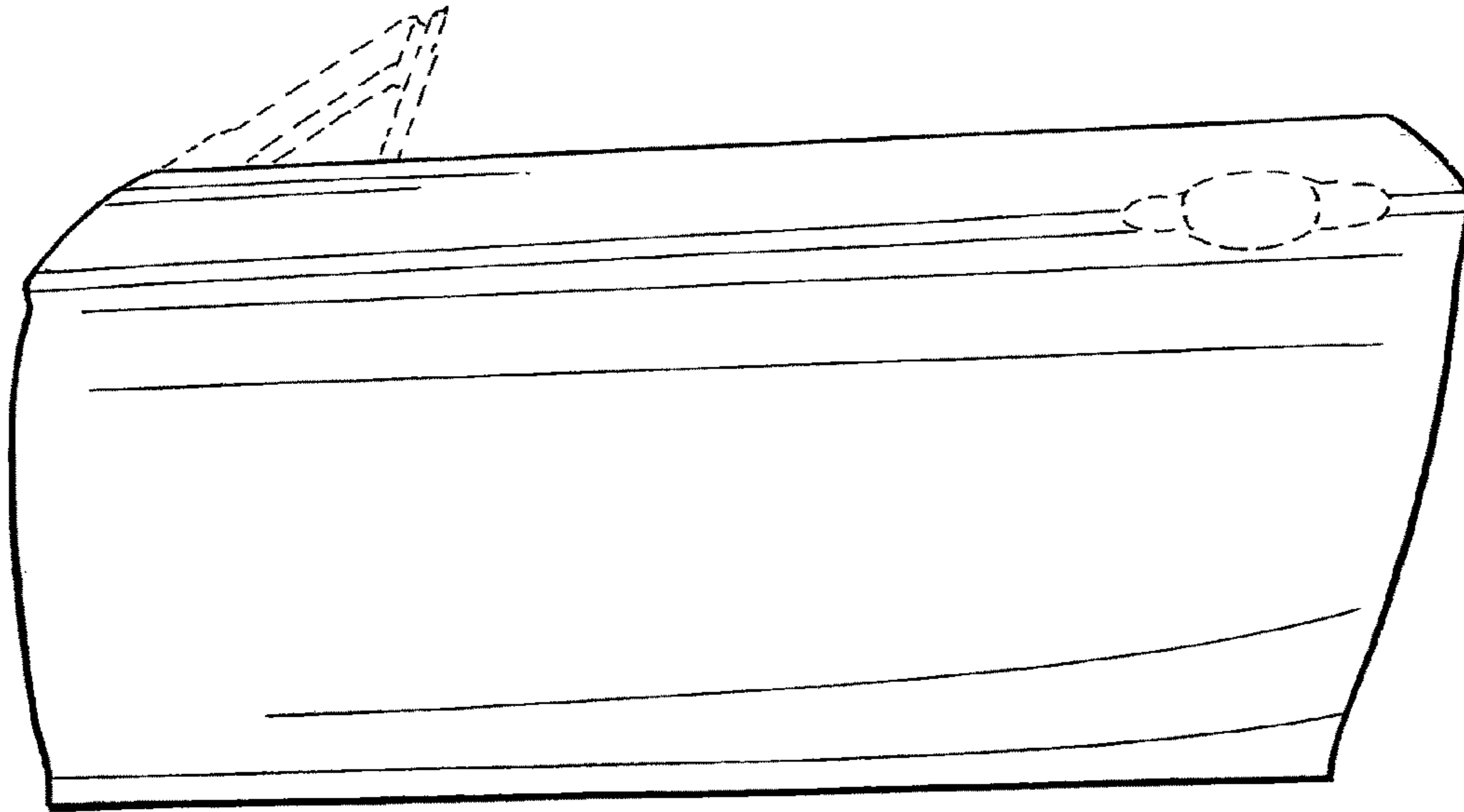

FIG. 3

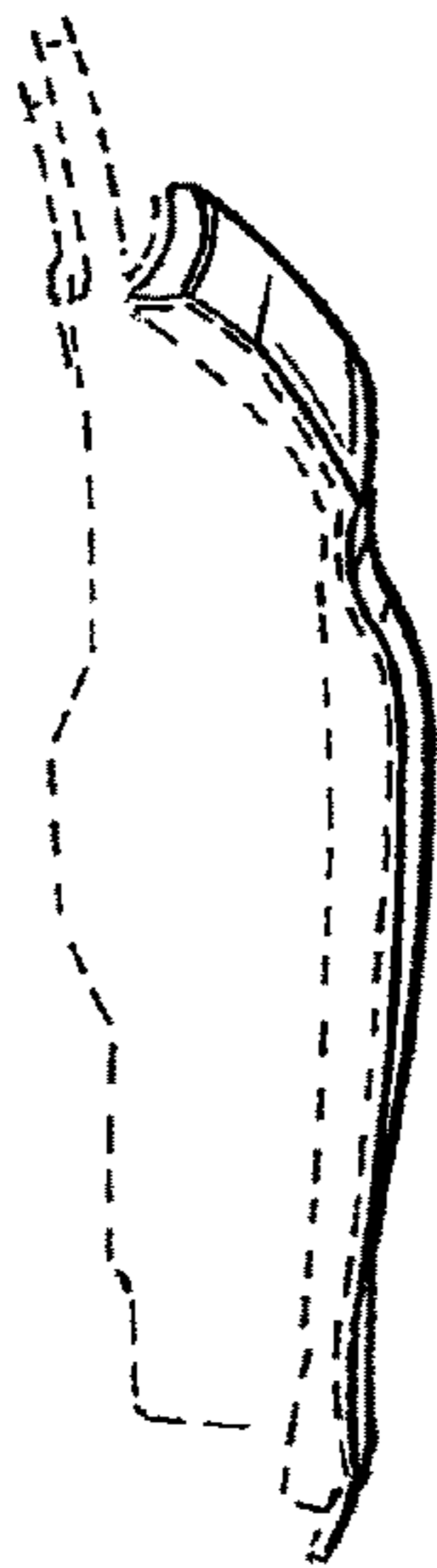

FIG. 4

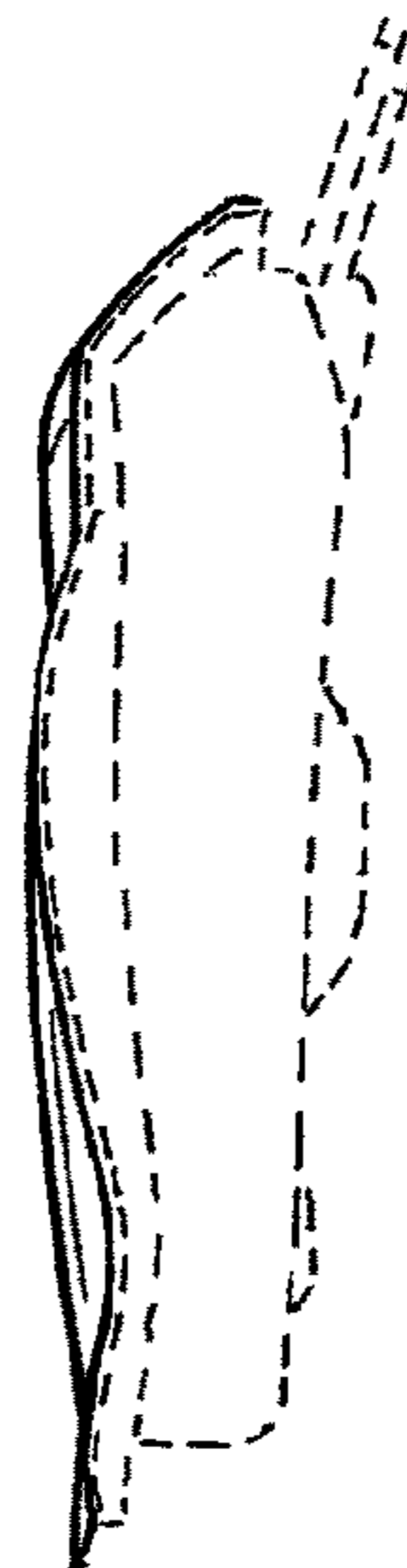

FIG. 5

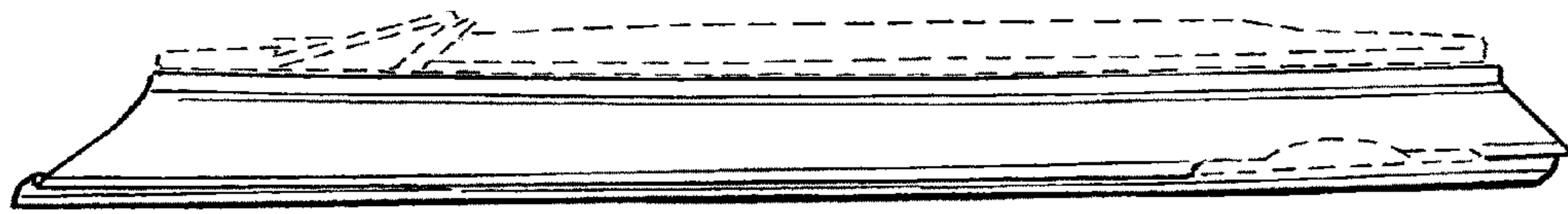

FIG. 6

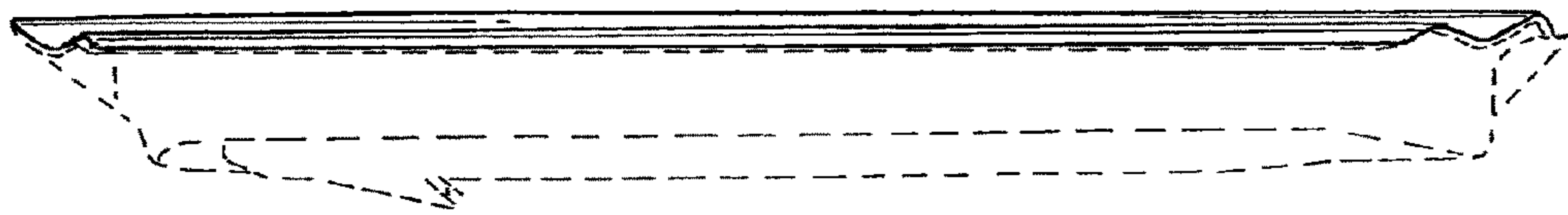

FIG. 7

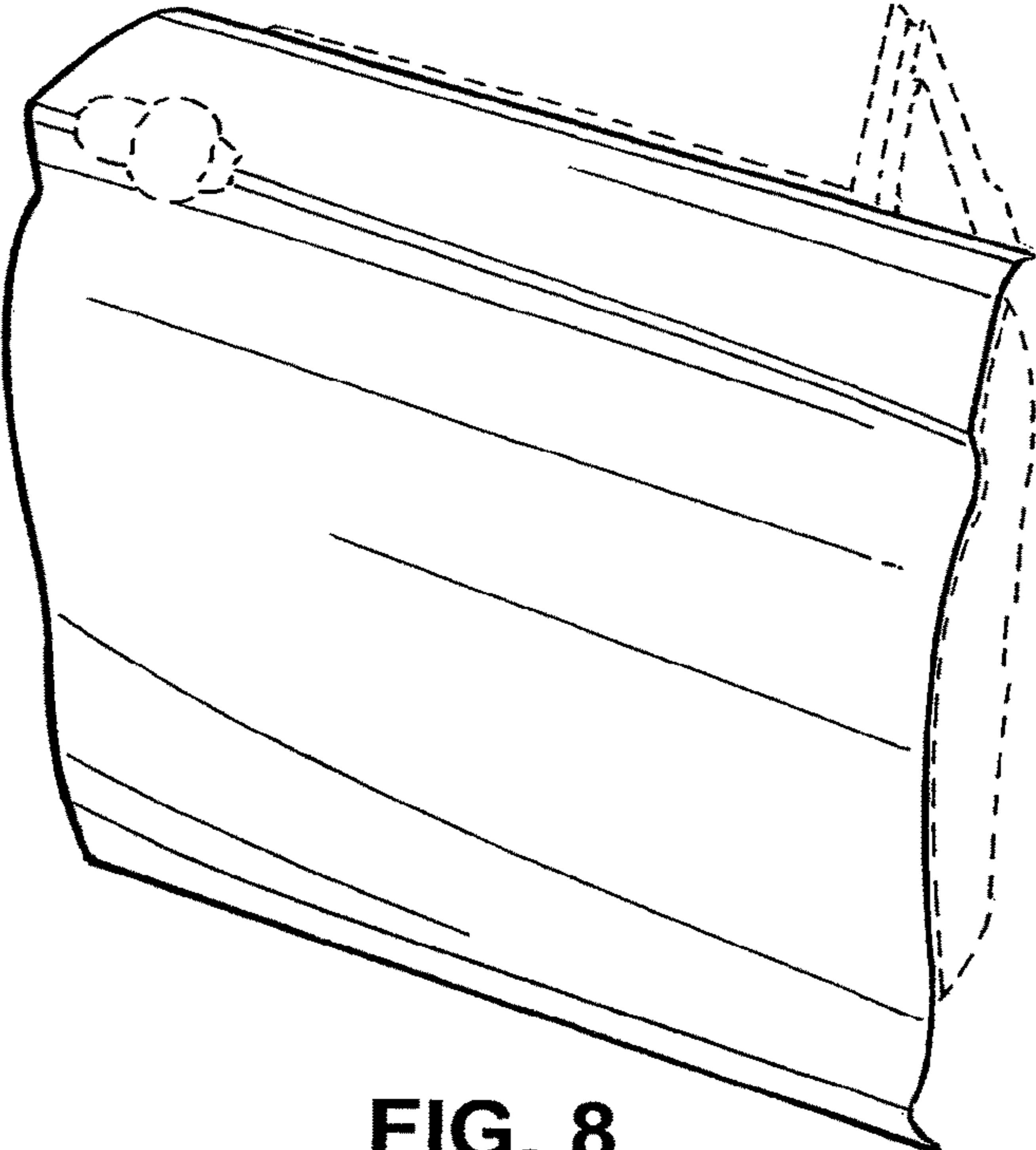

FIG. 8

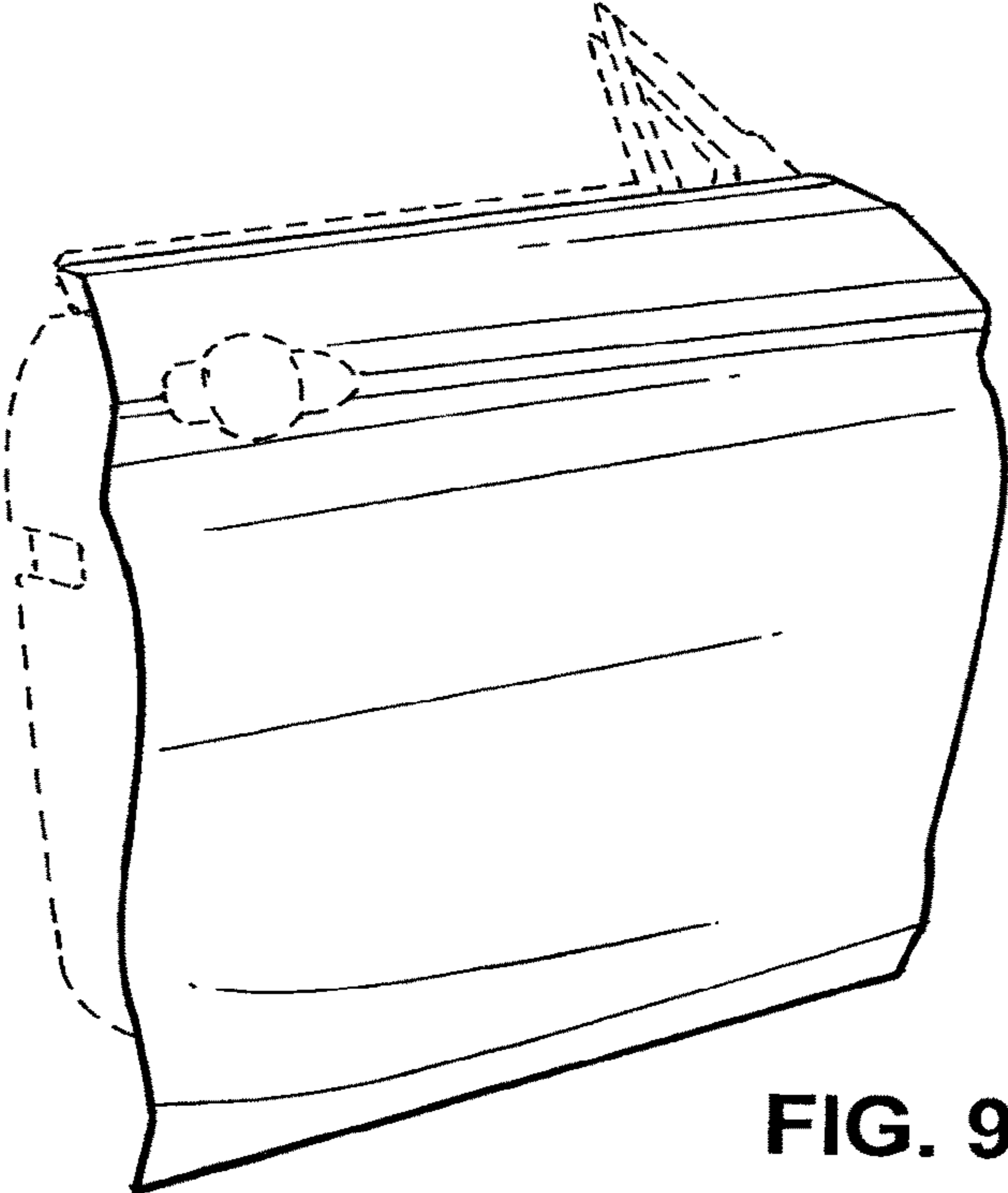

FIG. 9

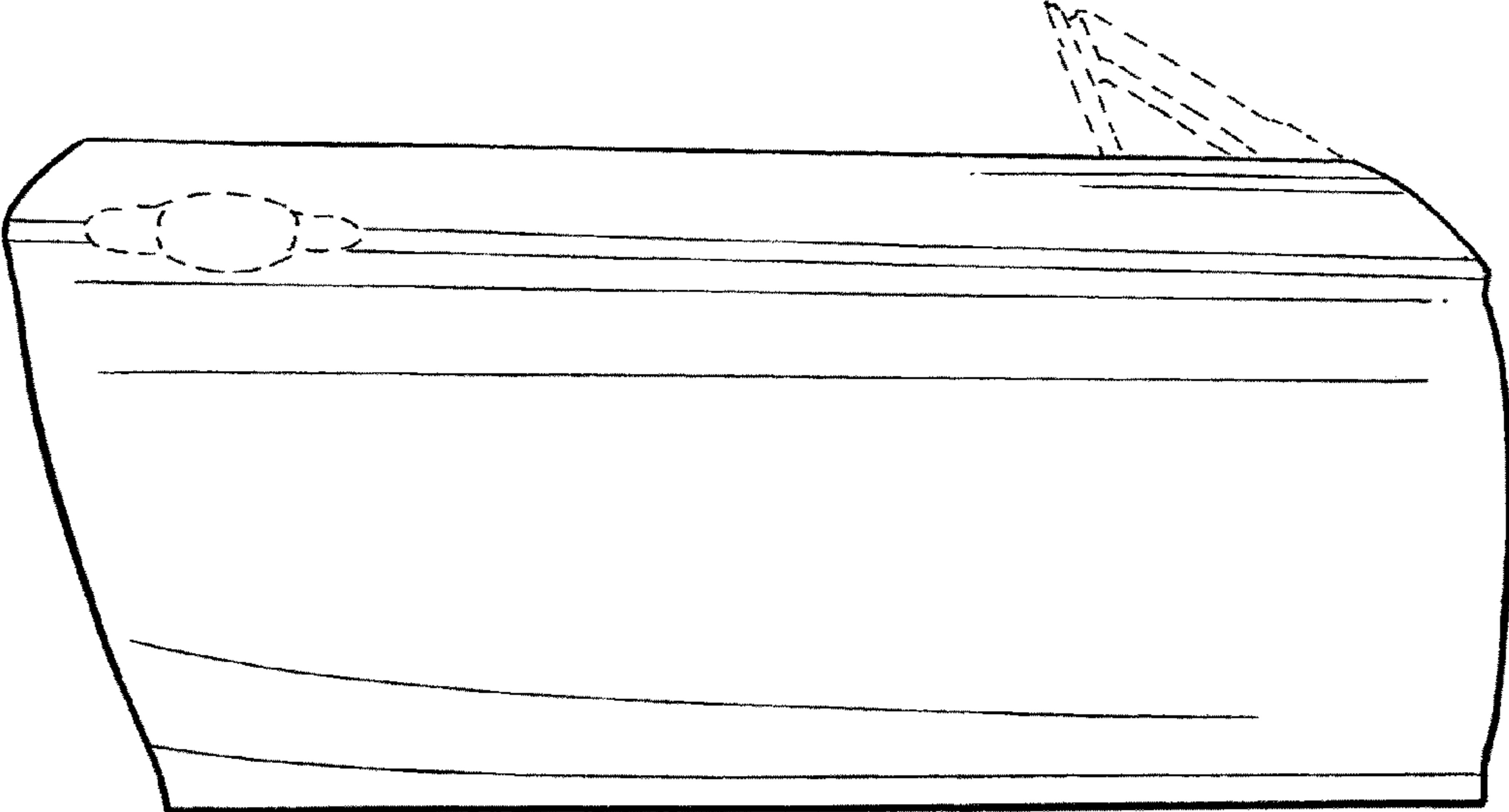

FIG. 10

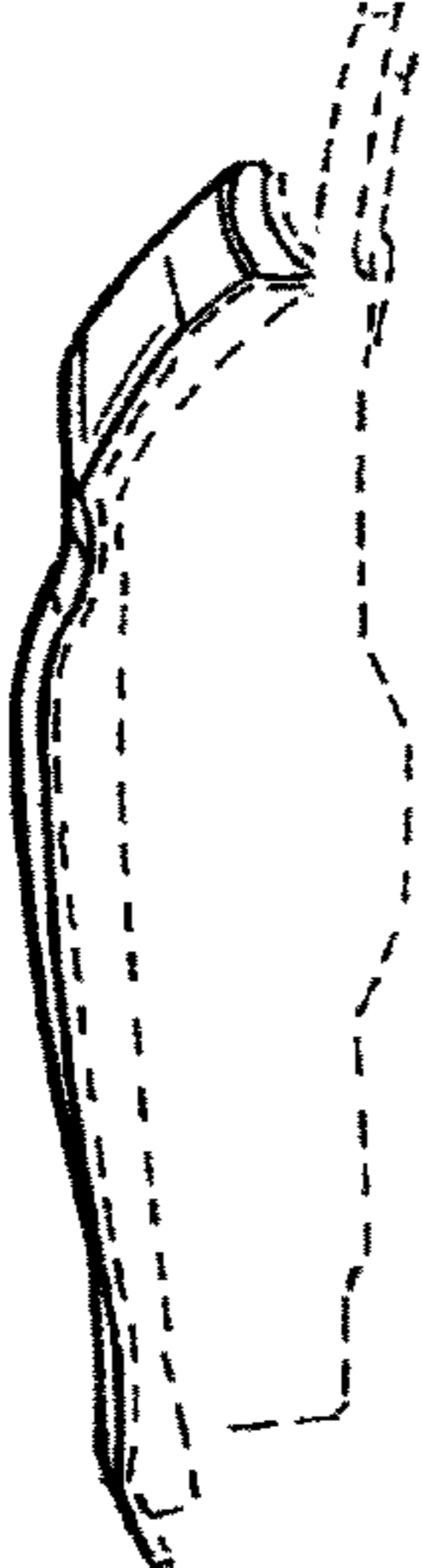

FIG. 11

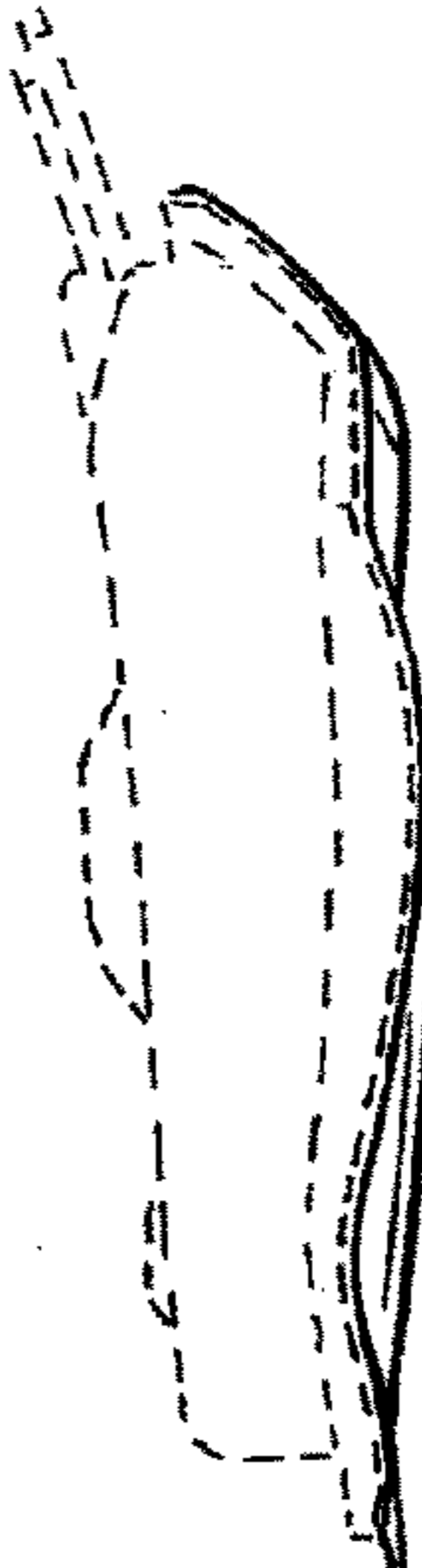

FIG. 12



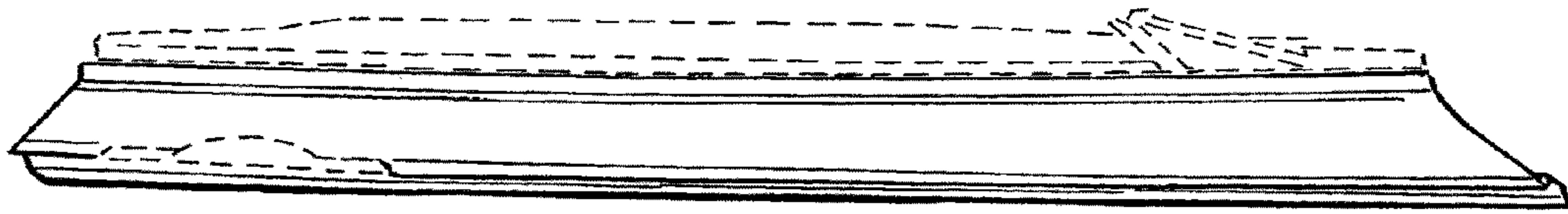

FIG. 13

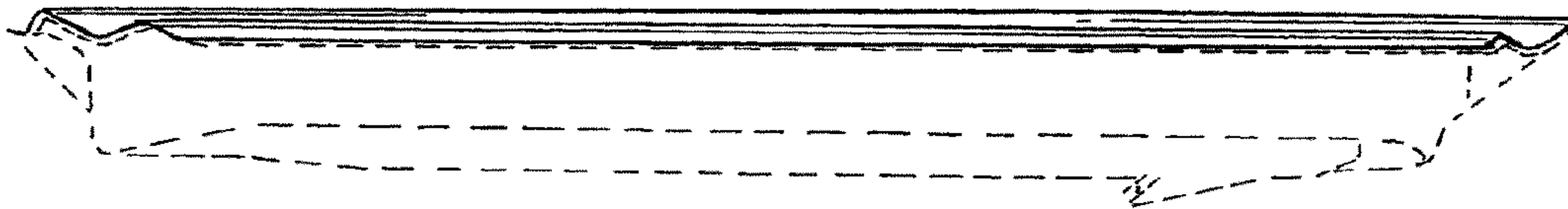

FIG. 14