

US00D665311S

(12) **United States Design Patent**
Presz, Jr. et al.

(10) **Patent No.:** **US D665,311 S**

(45) **Date of Patent:** **** Aug. 14, 2012**

(54) **WIND TURBINE**

(75) Inventors: **Walter M. Presz, Jr.**, Wilbraham, MA (US); **Michael J. Werle**, West Hartford, CT (US); **Ercan Dumlupinar**, Palmer, MA (US)

(73) Assignee: **FloDesign Wind Turbine Corporation**, Waltham, MA (US)

(**) Term: **14 Years**

(21) Appl. No.: **29/378,411**

(22) Filed: **Nov. 4, 2010**

(51) **LOC (9) Cl.** **12-07**

(52) **U.S. Cl.** **D12/115; D12/345**

(58) **Field of Classification Search** D12/344, D12/345; D13/115, 118, 122, 199, 179; D15/1, 199, 5; D21/458, 455; D23/379, D23/411, 413; 290/44, 54, 55; 60/262; 415/4.2, 415/4.3, 1, 115, 191, 208, 220; D24/110
See application file for complete search history.

(56) **References Cited**

U.S. PATENT DOCUMENTS

D92,600	S	*	6/1934	Hunt	D12/211
D325,019	S	*	3/1992	Boyer	D12/211
D628,962	S	*	12/2010	Presz et al.	D13/115
D629,095	S	*	12/2010	Liu et al.	D23/411
D629,356	S	*	12/2010	Presz et al.	D13/115
D635,511	S	*	4/2011	Presz et al.	D13/115
D640,978	S	*	7/2011	Presz et al.	D13/115
D640,979	S	*	7/2011	Presz et al.	D13/115
D640,980	S	*	7/2011	Presz et al.	D13/115
D640,981	S	*	7/2011	Presz et al.	D13/115
D642,526	S	*	8/2011	Presz et al.	D13/115

D644,606	S	*	9/2011	Presz et al.	D13/115
D647,847	S	*	11/2011	Presz et al.	D13/115
2009/0214338	A1	*	8/2009	Werle et al.	415/220
2009/0263244	A1	*	10/2009	Presz et al.	416/1
2010/0316493	A1	*	12/2010	Presz et al.	415/191
2011/0189007	A1	*	8/2011	Presz et al.	415/208.1
2011/0229315	A1	*	9/2011	Presz et al.	415/191
2011/0250053	A1	*	10/2011	Presz et al.	415/115
2011/0250062	A1	*	10/2011	Presz et al.	415/208.2
2012/0070275	A1	*	3/2012	Presz et al.	415/208.1

* cited by examiner

Primary Examiner — Austin Murphy

(74) *Attorney, Agent, or Firm* — Fay Sharpe LLP

(57) **CLAIM**

The ornamental design for a wind turbine, as shown and described.

DESCRIPTION

FIG. 1 is a front view of the wind turbine;
FIG. 2 is a left side view of the wind turbine;
FIG. 3 is a rear view of the wind turbine;
FIG. 4 is a right side view the wind turbine;
FIG. 5 is a top view of the wind turbine;
FIG. 6 is a bottom view of the wind turbine;
FIG. 7 is a top front left perspective view of the wind turbine;
and,
FIG. 8 is a top rear left perspective view of the wind turbine.
The broken lines shown in the drawings represent portions of the wind turbine that form no part of the claimed design. Where broken lines adjoin a claimed surface it is understood that those broken lines represent an unclaimed boundary between claimed and unclaimed surfaces and form no part of the claimed design.

1 Claim, 4 Drawing Sheets

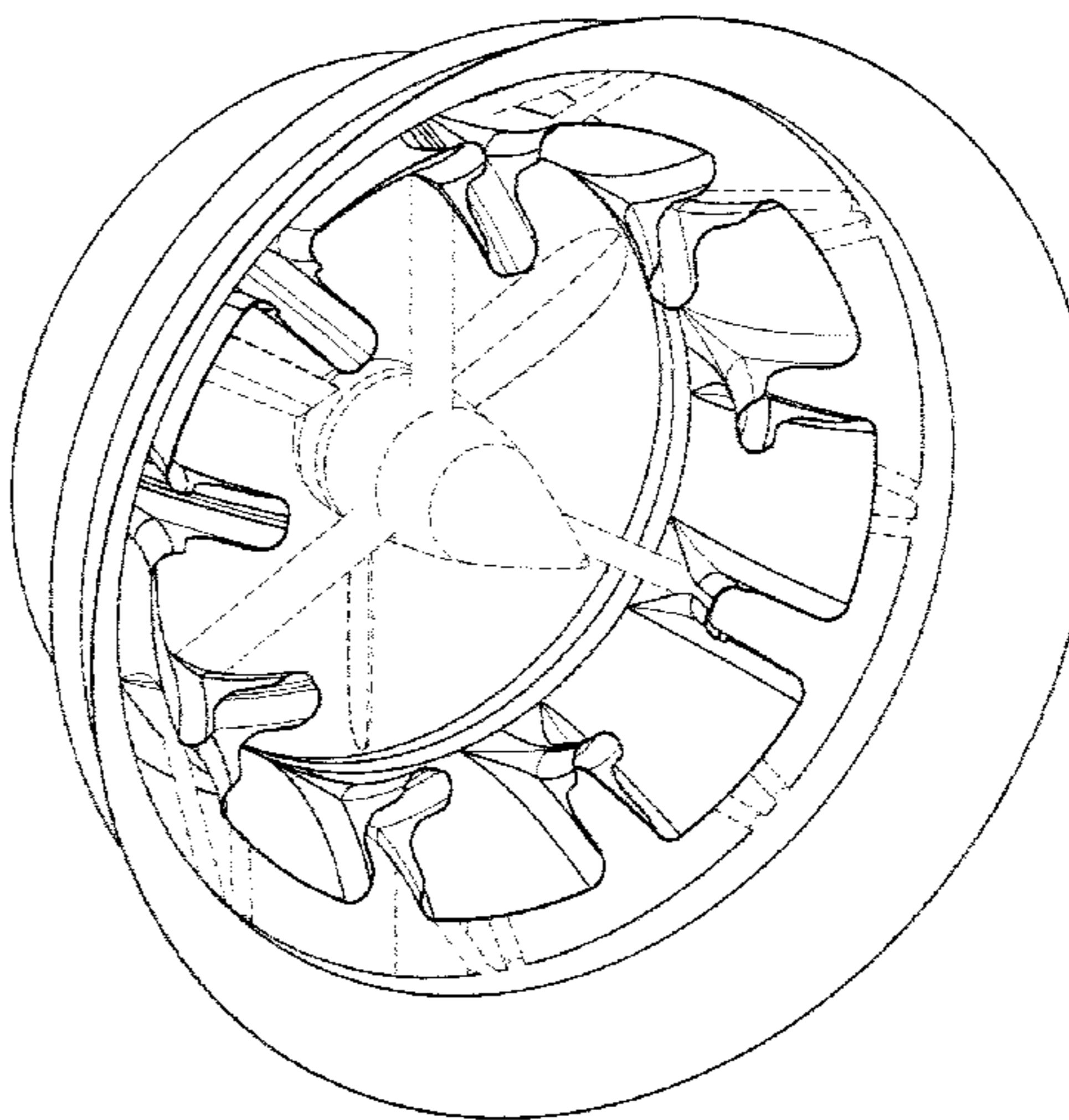
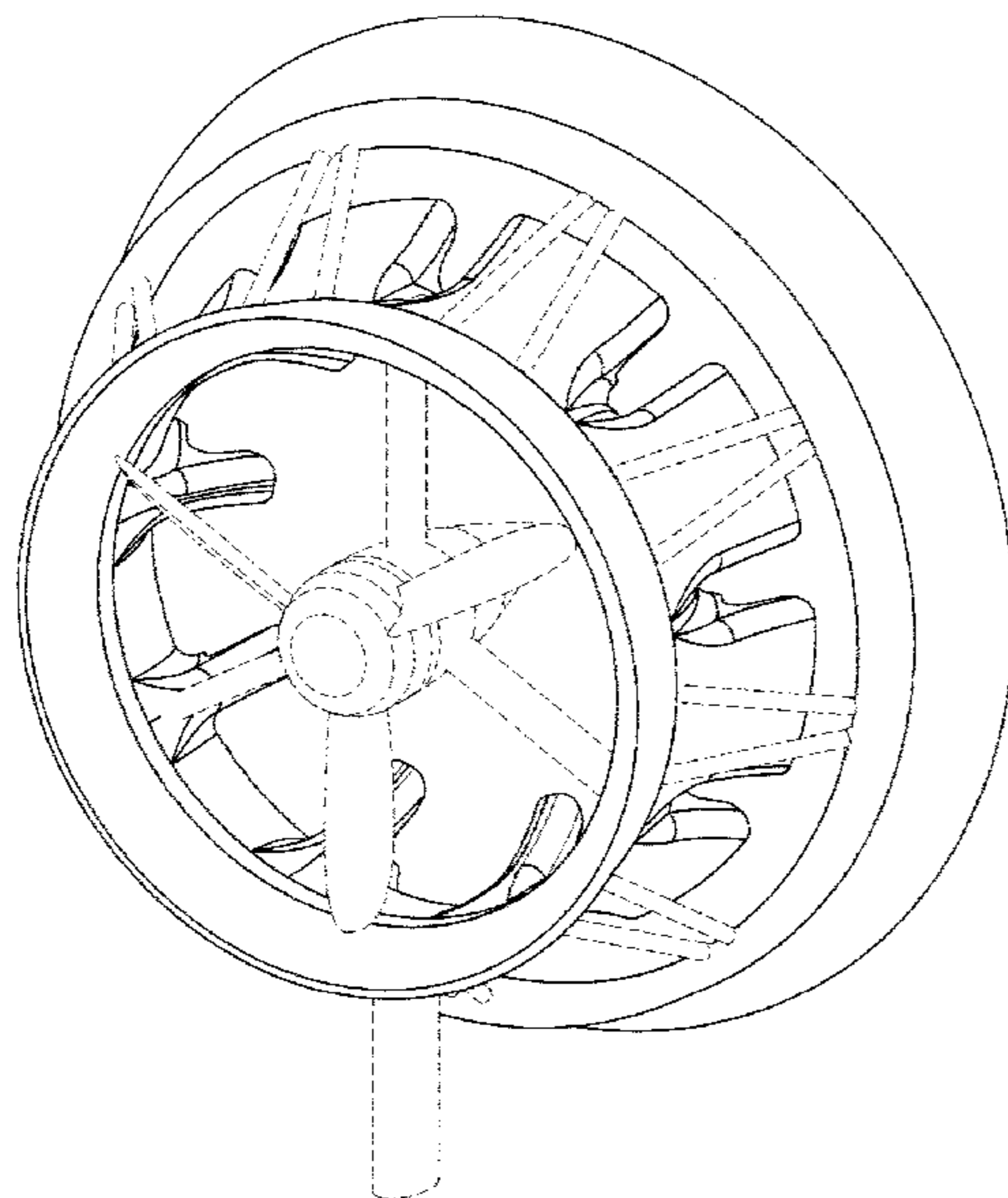

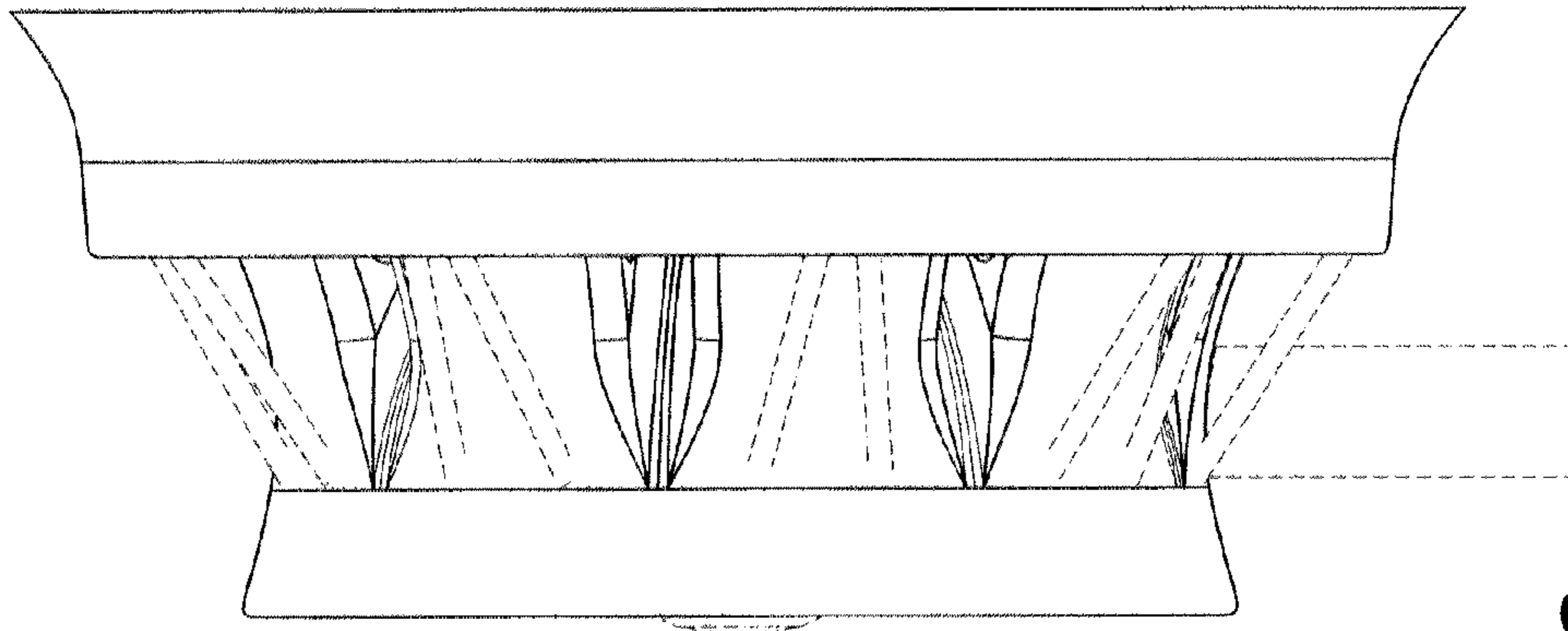

FIG. 2

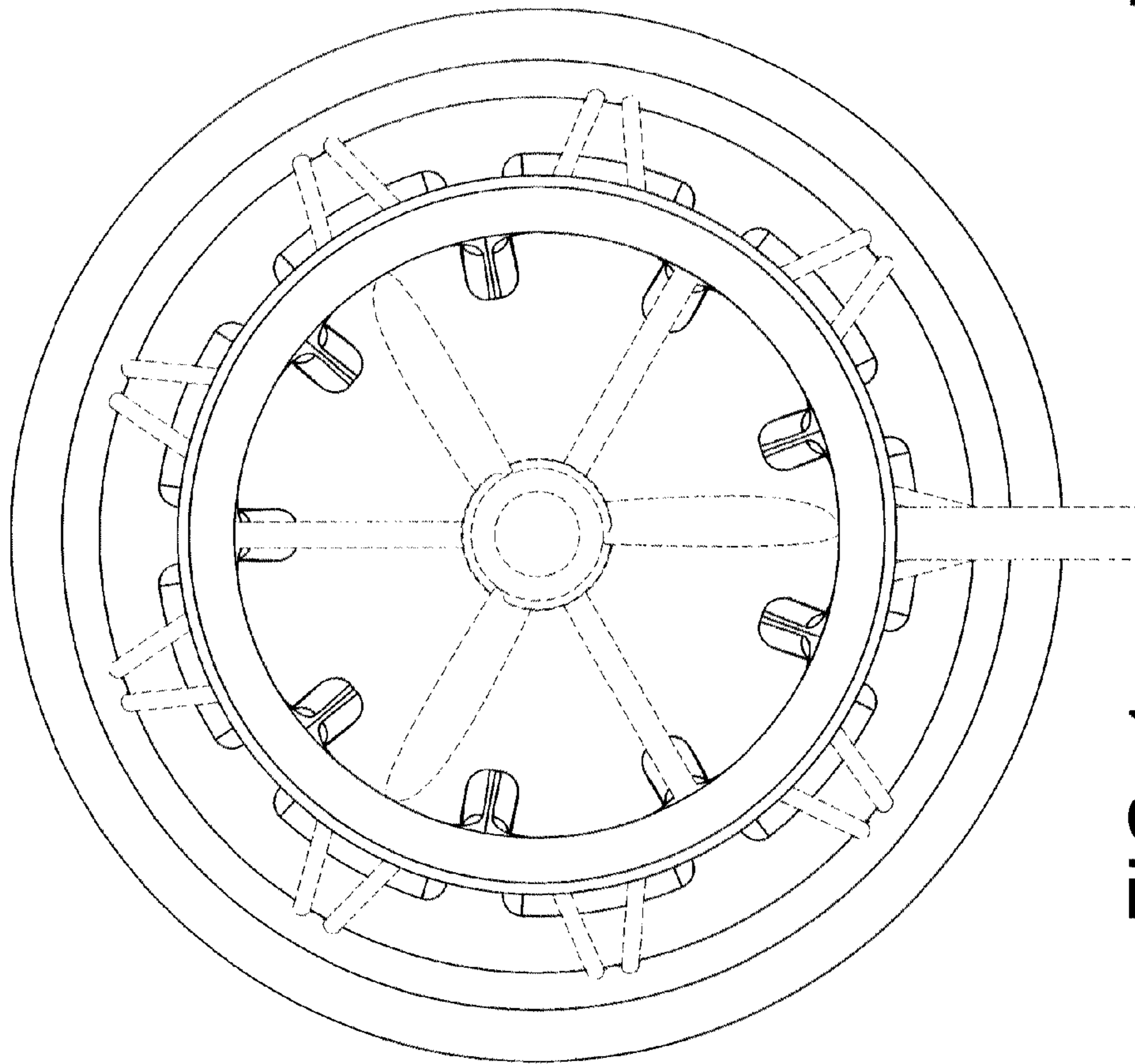

FIG. 1

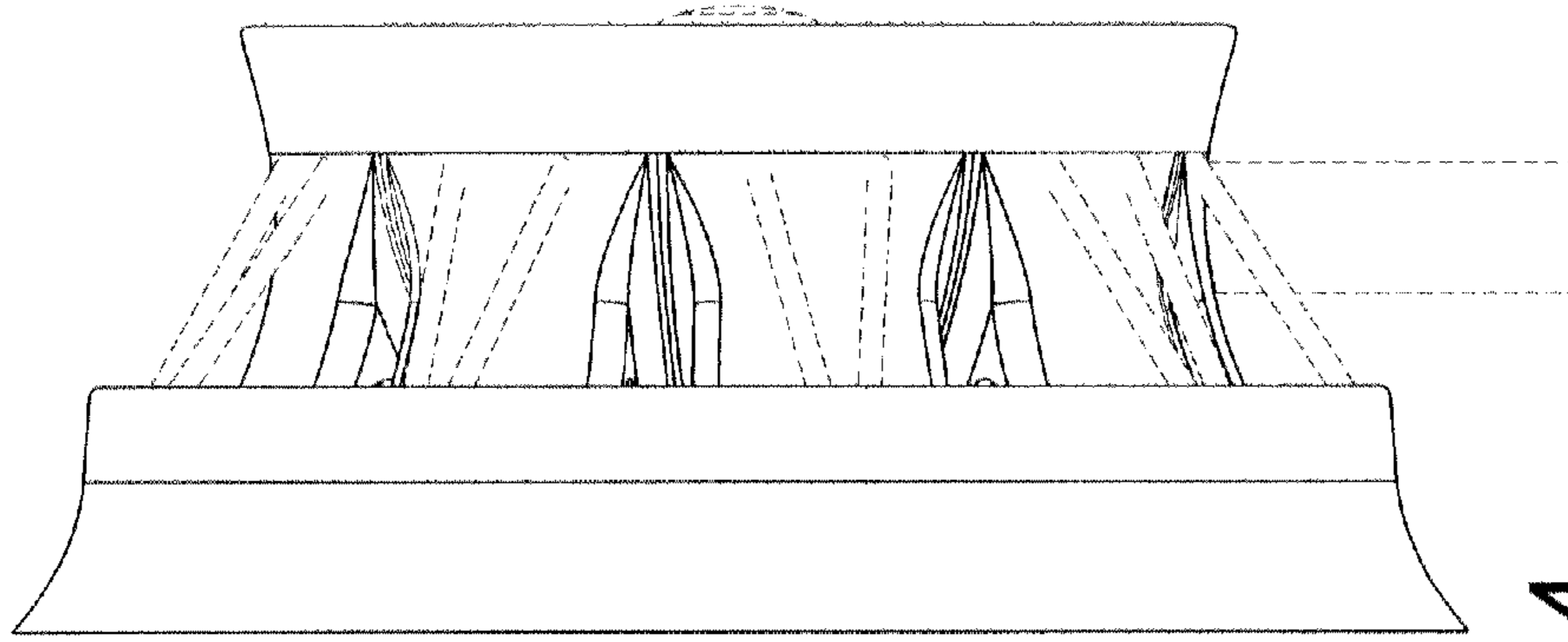

FIG. 4

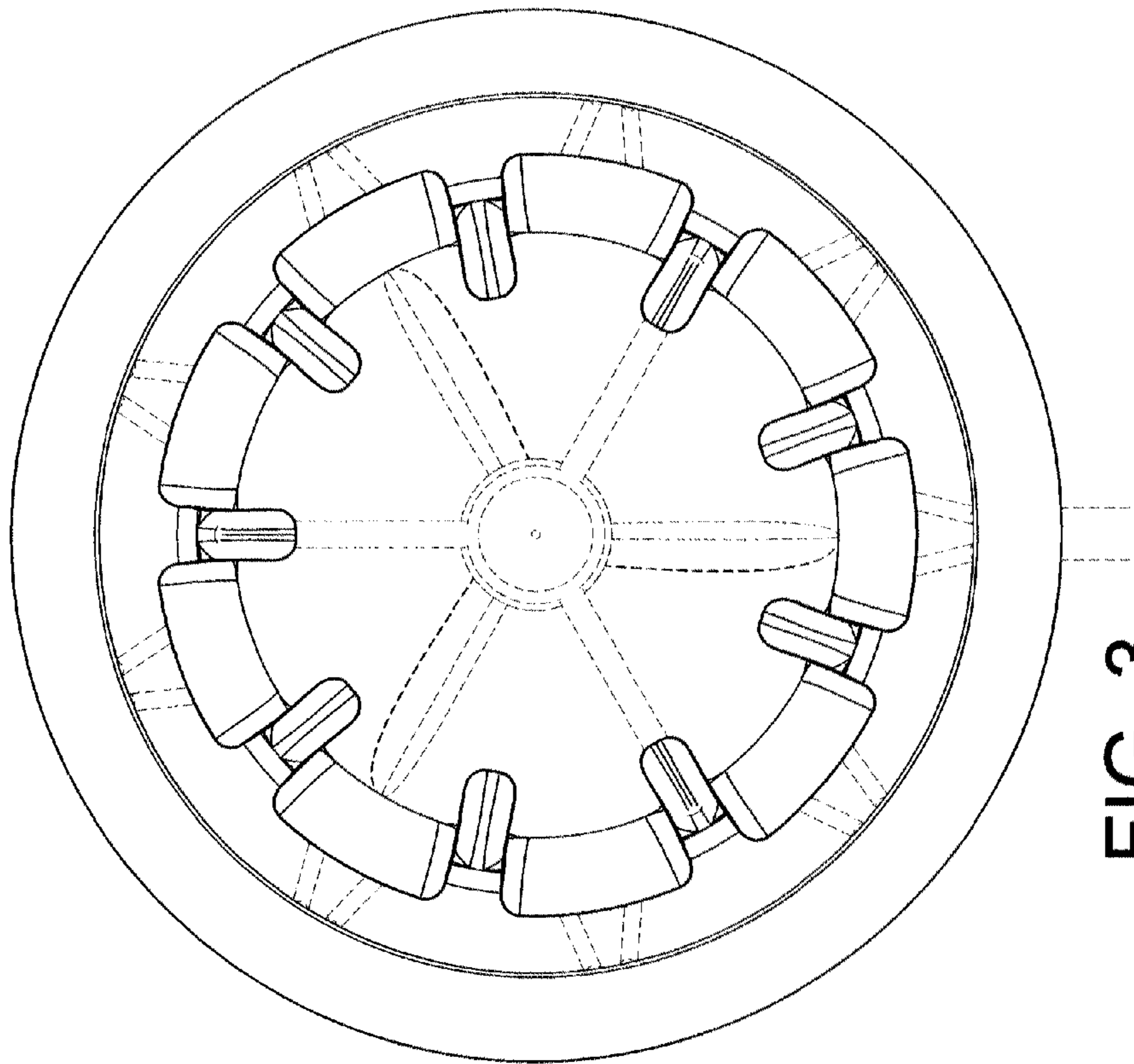

FIG. 3

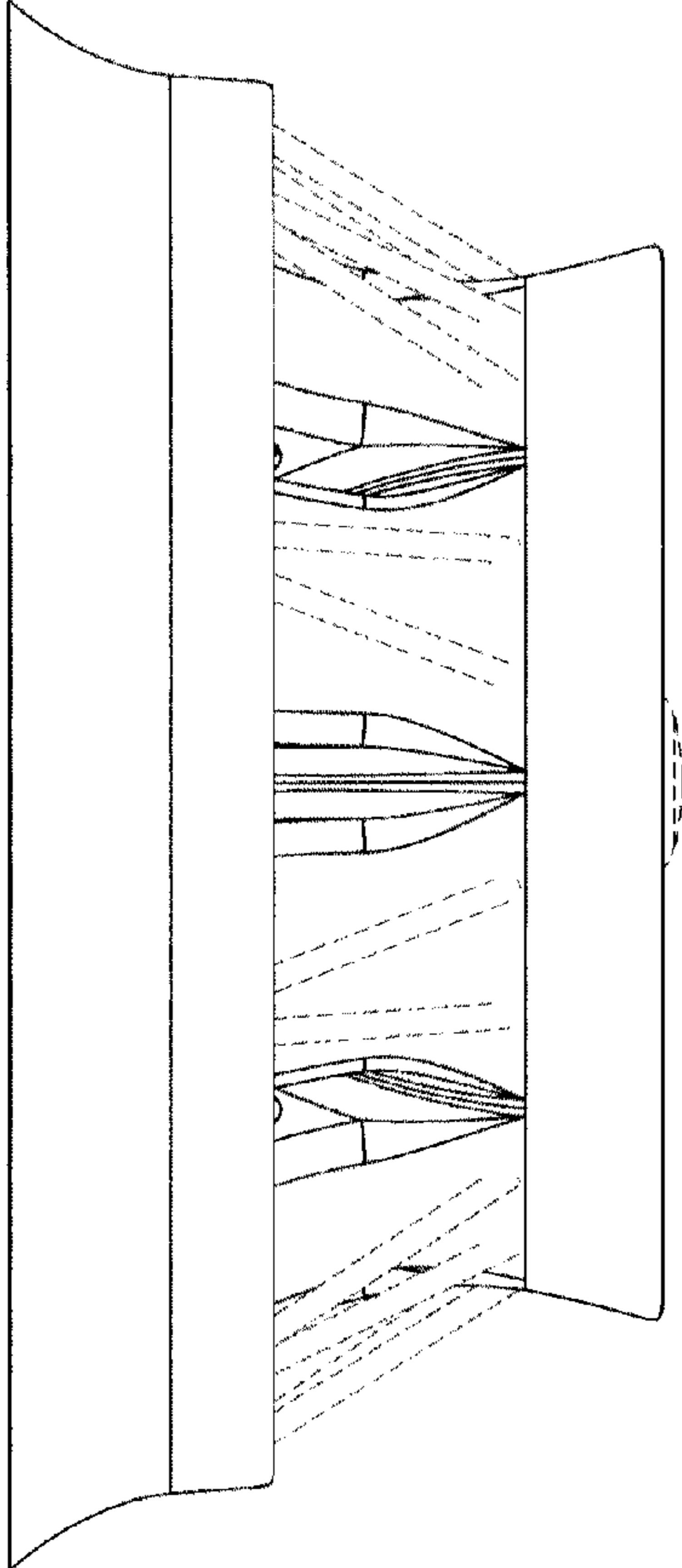

FIG. 5

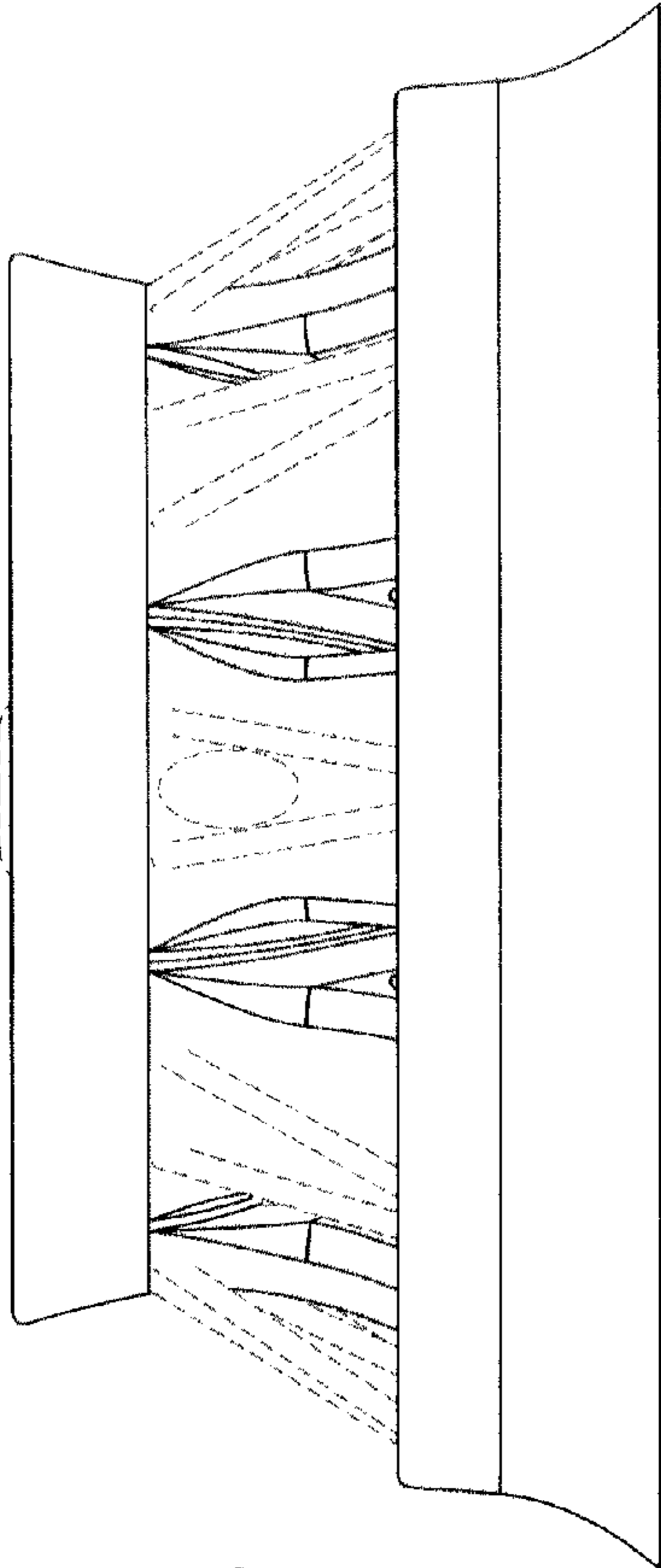

FIG. 6

FIG. 7

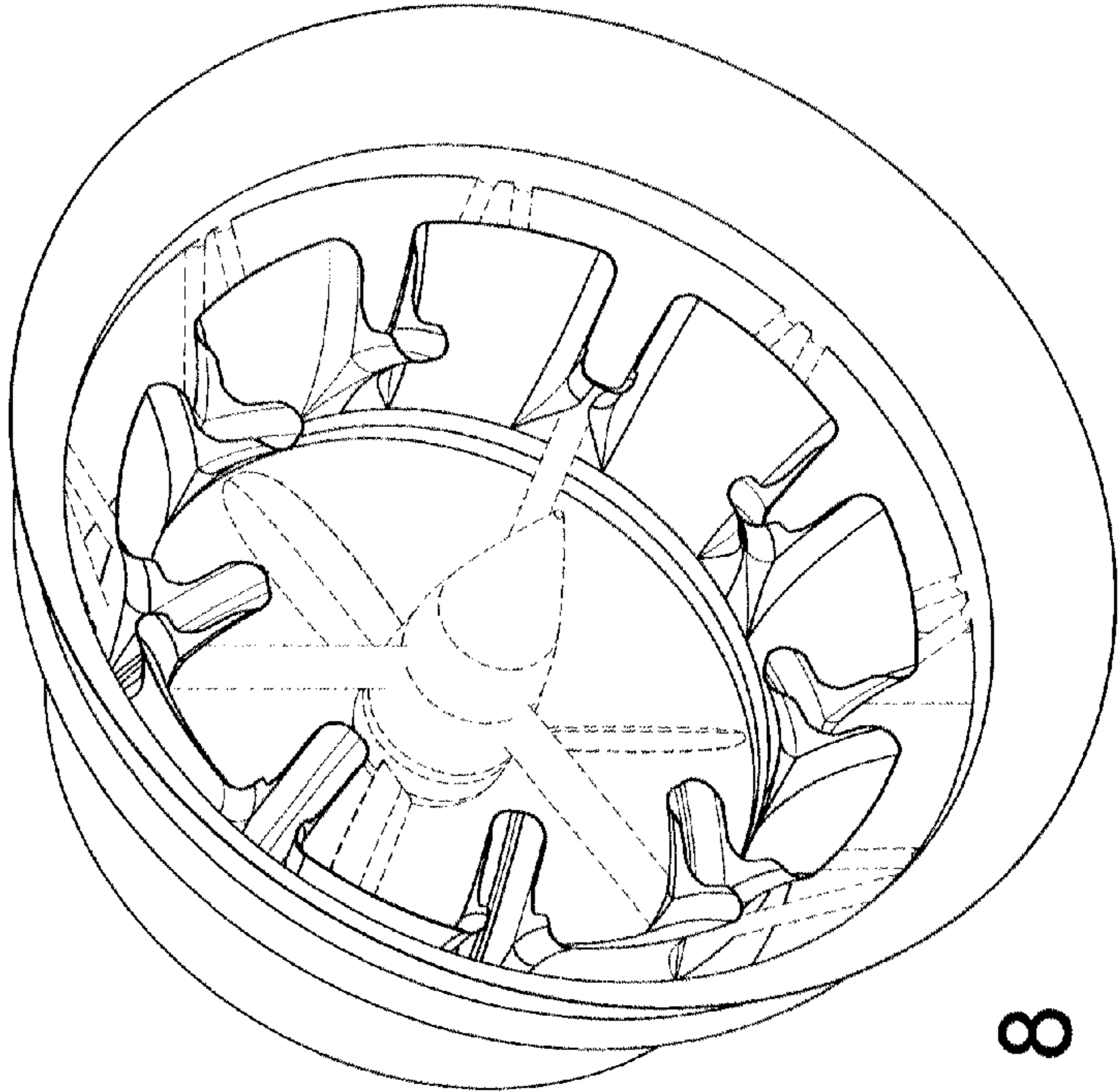

FIG. 8

