



US00D665287S

(12) **United States Design Patent**
Fukano et al.

(10) **Patent No.:** **US D665,287 S**

(45) **Date of Patent:** **** Aug. 14, 2012**

(54) **ELECTROMAGNETIC FLOW METER**

(75) Inventors: **Yoshihiro Fukano**, Tsukubamirai (JP);
Takamitsu Suzuki, Tsukubamirai (JP)

(73) Assignee: **SMC Corporation**, Chiyoda-ku, Tokyo
(JP)

(**) Term: **14 Years**

(21) Appl. No.: **29/411,015**

(22) Filed: **Jan. 16, 2012**

(30) **Foreign Application Priority Data**

Jul. 15, 2011 (JP) 2011-016291

(51) **LOC (9) Cl.** **10-06**

(52) **U.S. Cl.** **D10/96**

(58) **Field of Classification Search** D10/96,
D10/97, 99, 100, 101; 116/264, 276; 73/273,
73/323, 861-861.41

See application file for complete search history.

(56) **References Cited**

U.S. PATENT DOCUMENTS

D397,053 S * 8/1998 Lloyd D10/99
D440,896 S * 4/2001 Asai et al. D10/96

D447,072 S * 8/2001 Asai et al. D10/96
D602,794 S * 10/2009 Oshima D10/96
D602,795 S * 10/2009 Oshima D10/96
2004/0261519 A1 * 12/2004 Nozoe et al. 73/204.21
2009/0260453 A1 * 10/2009 Kawakami et al. 73/861.12
2012/0038143 A1 * 2/2012 Shih 73/861.08

* cited by examiner

Primary Examiner — Antoine D Davis

(74) *Attorney, Agent, or Firm* — Yokoi & Co., U.S.A., Inc.;
Toshiyuki Yokoi

(57) **CLAIM**

The ornamental design for an electromagnetic flow meter, as shown and described.

DESCRIPTION

FIG. 1 shows a front view of an electromagnetic flow meter showing our new design;
FIG. 2 shows a rear view thereof;
FIG. 3 shows a right side view thereof;
FIG. 4 shows a left side view thereof;
FIG. 5 shows a top view thereof;
FIG. 6 shows a bottom view thereof; and,
FIG. 7 shows a top, front and left side perspective view thereof.

1 Claim, 4 Drawing Sheets

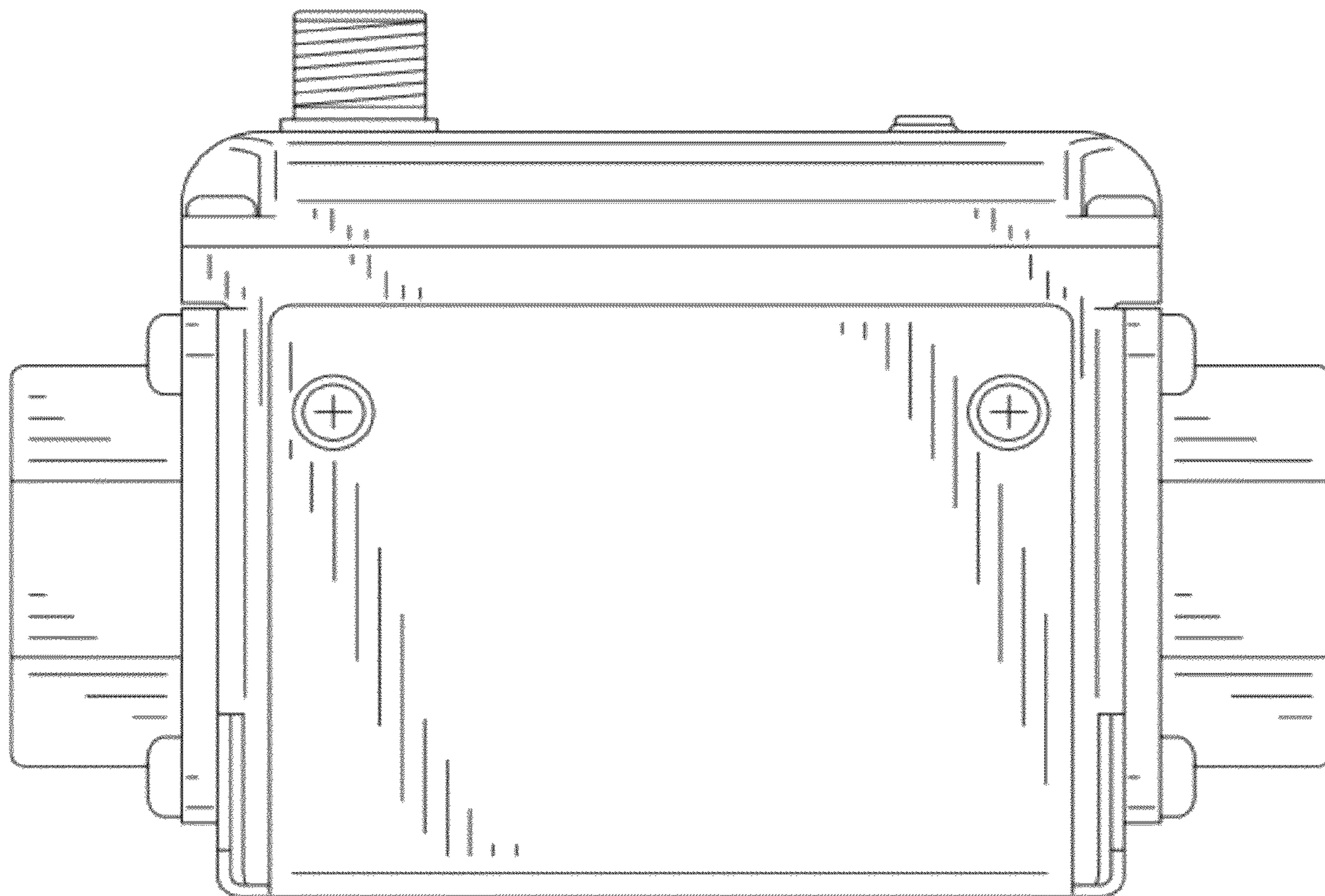

FIG. 1

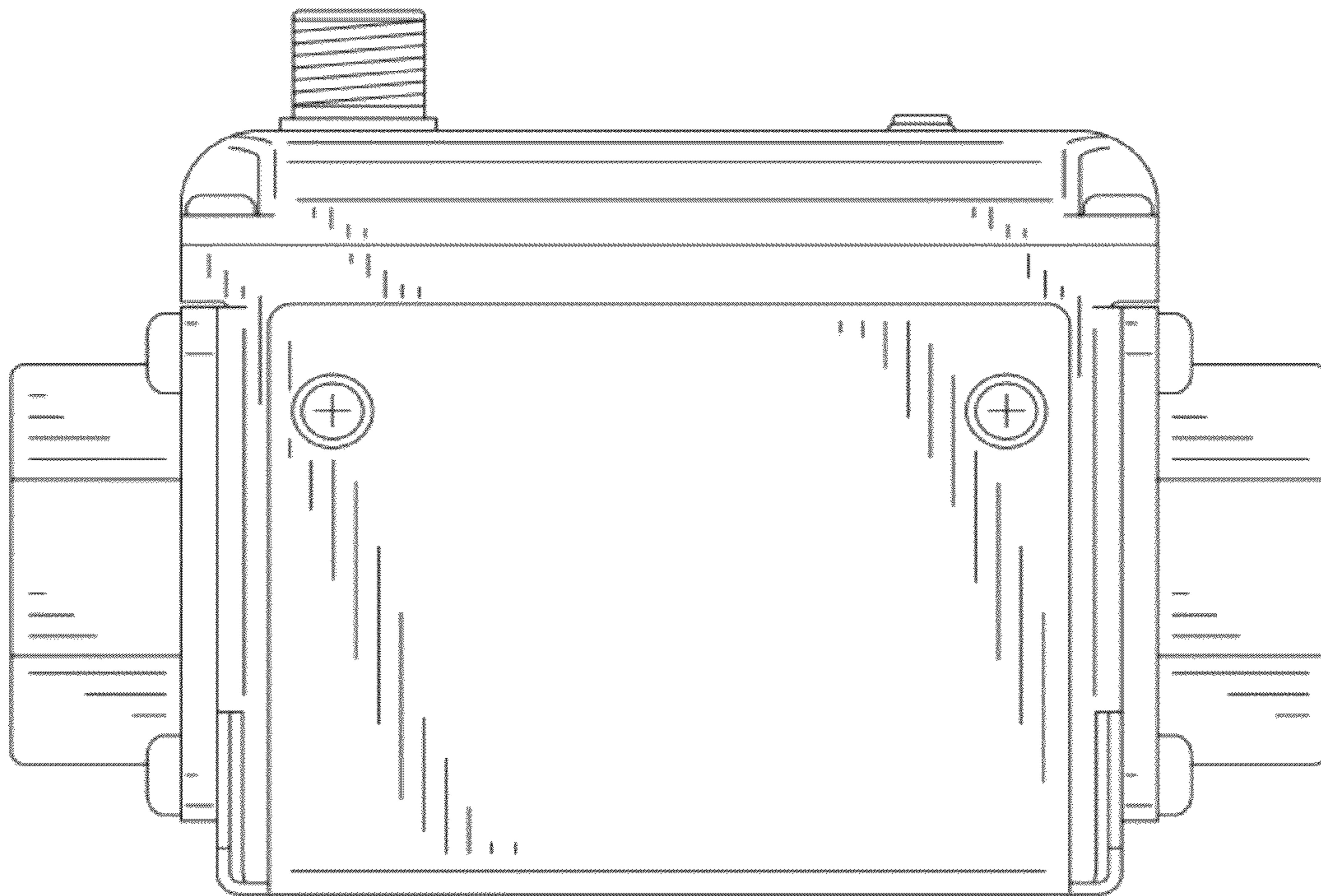

FIG. 2

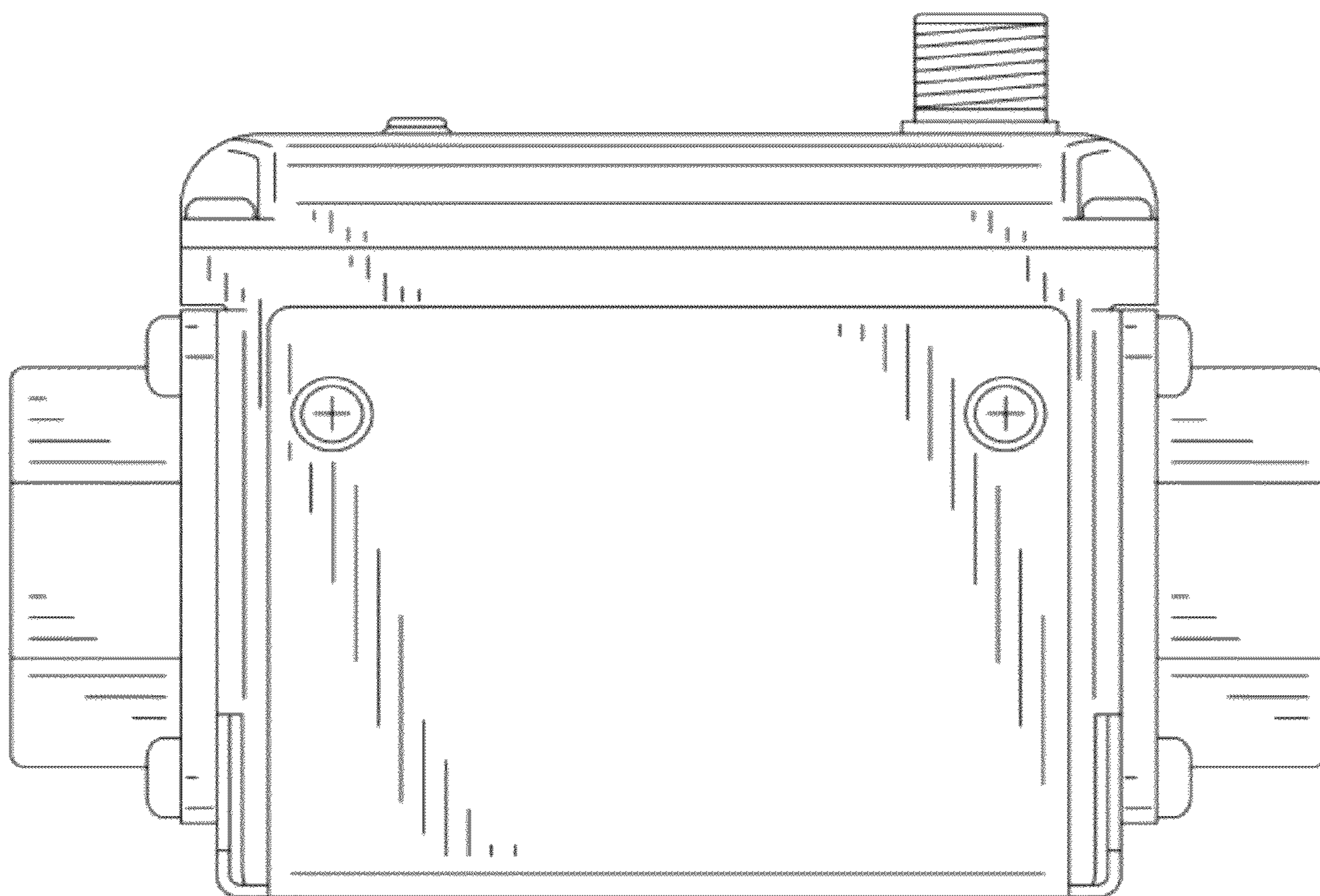

FIG. 3

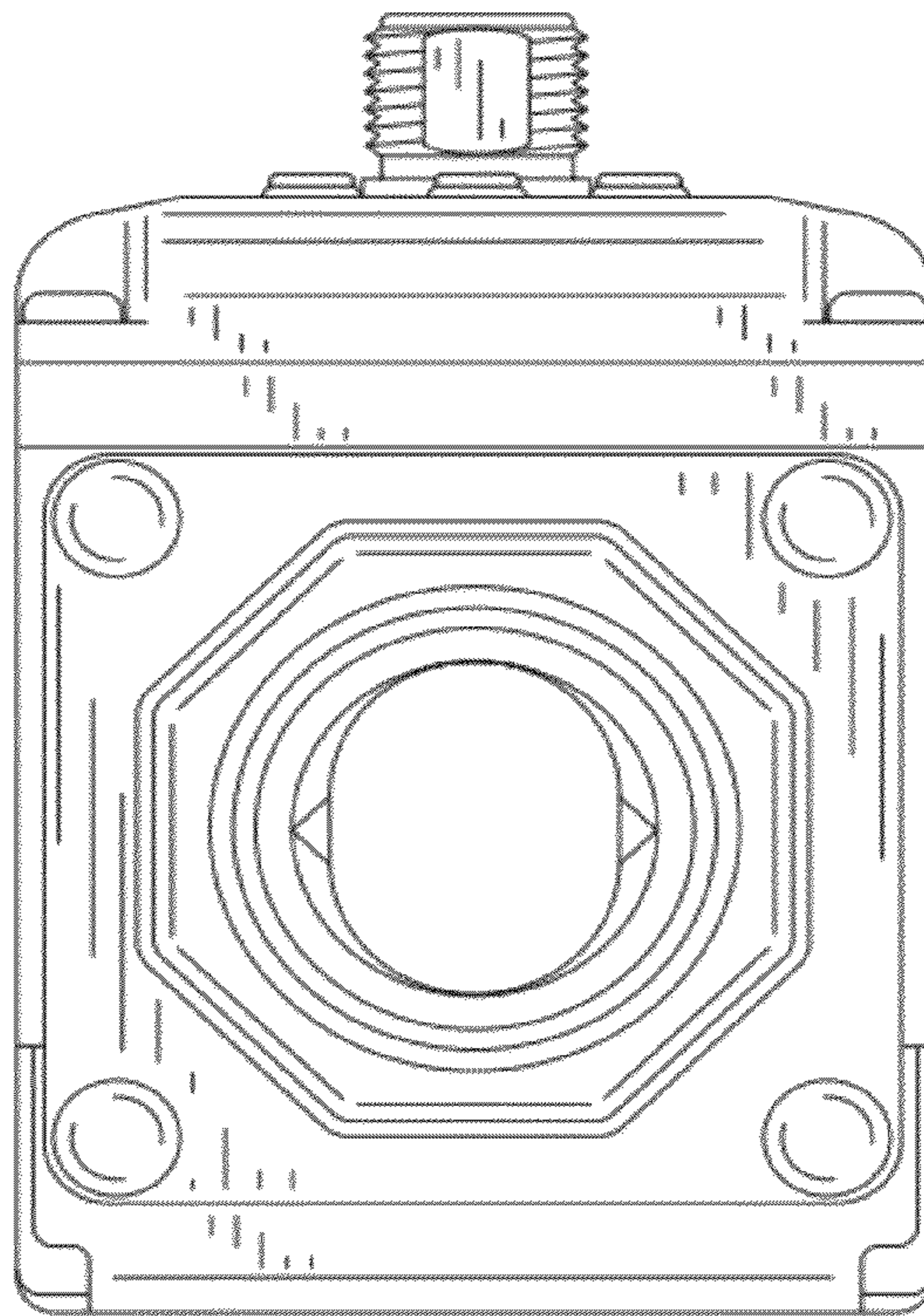

FIG. 4

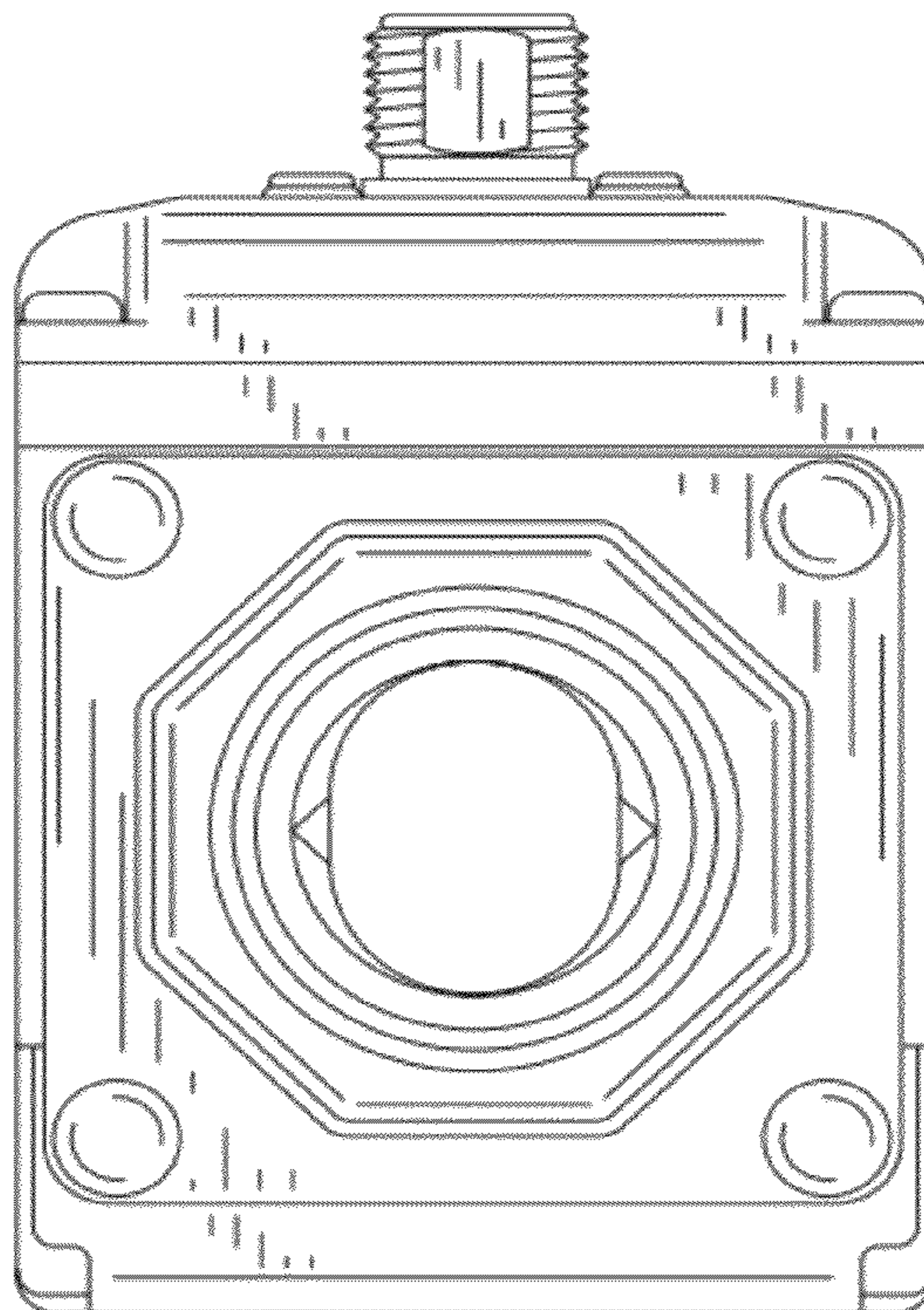

FIG. 5

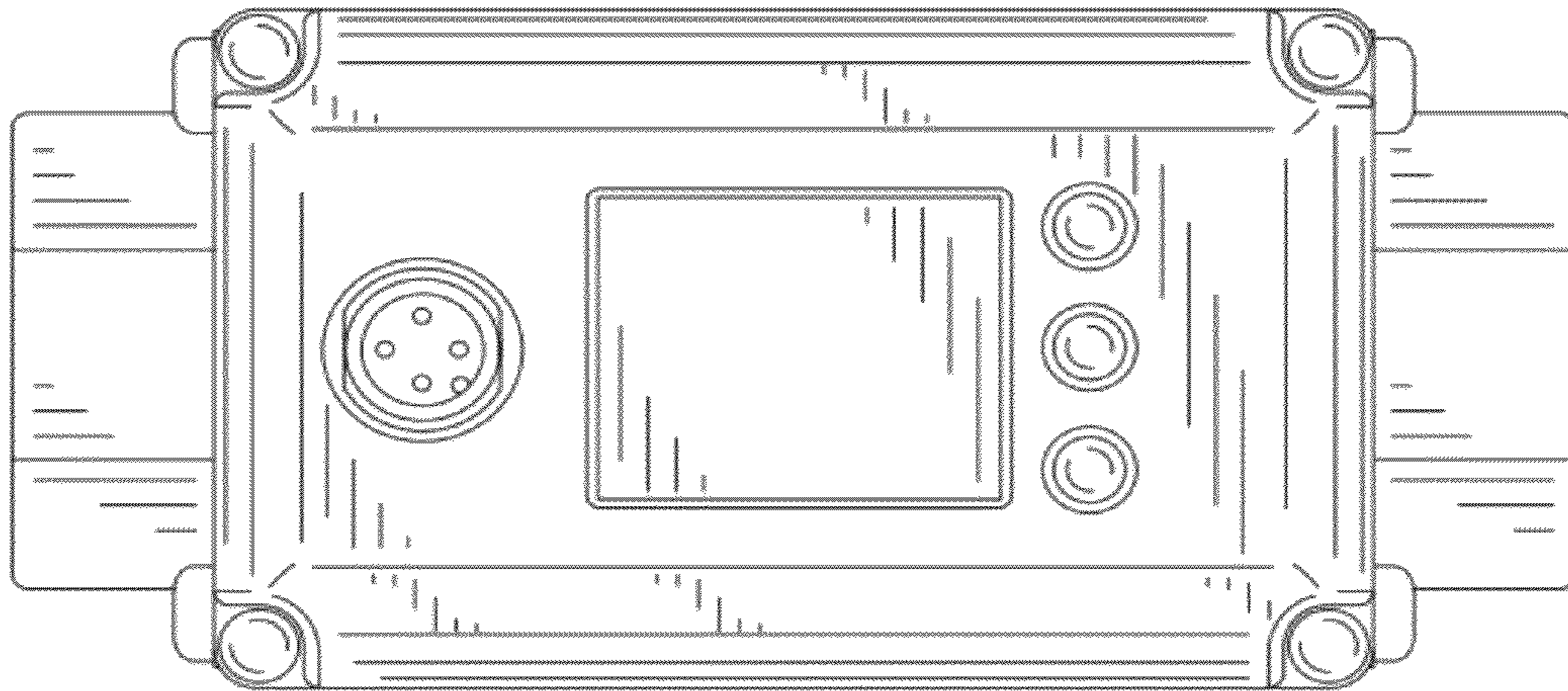

FIG. 6

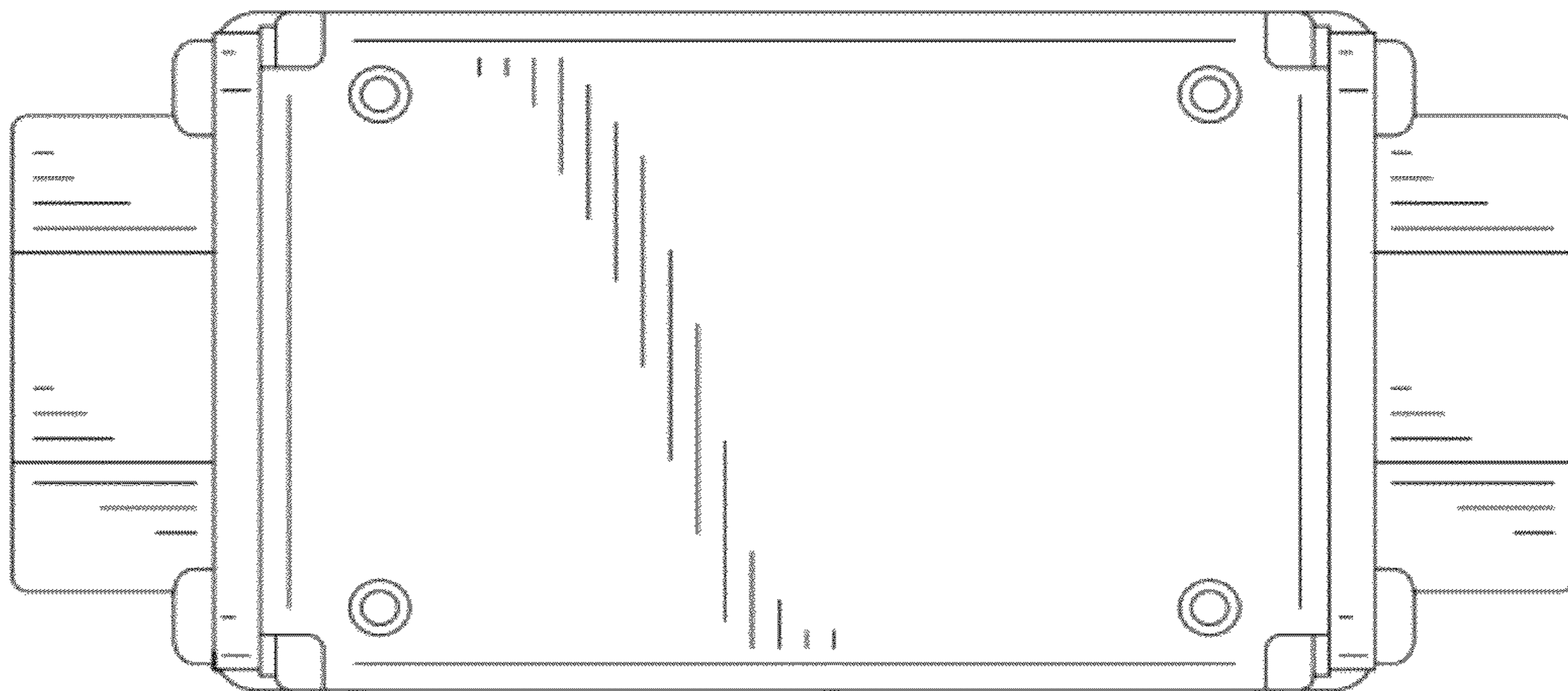

FIG. 7

