

US00D665262S

(12) **United States Design Patent**  
**Regas**

(10) **Patent No.:** **US D665,262 S**  
(45) **Date of Patent:** **\*\* Aug. 14, 2012**

(54) **BEVERAGE CONTAINER**

(76) Inventor: **John P. Regas**, Laguna Niguel, CA (US)

(\*\*) Term: **14 Years**

(21) Appl. No.: **29/402,175**

(22) Filed: **Sep. 21, 2011**

**Related U.S. Application Data**

(63) Continuation of application No. 29/303,771, filed on Feb. 15, 2008, now Pat. No. Des. 647,803.

(51) **LOC (9) Cl.** ..... **09-01**

(52) **U.S. Cl.** ..... **D9/516**

(58) **Field of Classification Search** ..... D9/516,  
D9/520, 544, 546, 560, 563, 566, 572, 573,  
D9/574; 215/381-385; 220/600, 608, 660,  
220/669, 675

See application file for complete search history.

(56) **References Cited**

**U.S. PATENT DOCUMENTS**

|           |     |         |            |       |         |
|-----------|-----|---------|------------|-------|---------|
| 1,611,443 | A * | 12/1926 | Hothersall | ..... | 222/542 |
| D83,658   | S * | 3/1931  | Becker     | ..... | D9/546  |
| 4,949,861 | A * | 8/1990  | Cochran    | ..... | 215/42  |
| 5,544,768 | A * | 8/1996  | Gargione   | ..... | 215/209 |
| D595,141  | S * | 6/2009  | Rica       | ..... | D9/544  |
| D601,024  | S * | 9/2009  | Rica       | ..... | D9/516  |

|          |     |         |              |       |        |
|----------|-----|---------|--------------|-------|--------|
| D603,716 | S * | 11/2009 | Rica         | ..... | D9/560 |
| D603,717 | S * | 11/2009 | Rica         | ..... | D9/560 |
| D604,174 | S * | 11/2009 | Rica         | ..... | D9/560 |
| D604,175 | S * | 11/2009 | Rica         | ..... | D9/560 |
| D605,055 | S * | 12/2009 | Serrano Diaz | ..... | D9/560 |
| D606,884 | S * | 12/2009 | Weggelaar    | ..... | D9/740 |
| D613,177 | S * | 4/2010  | Lee          | ..... | D9/560 |
| D614,958 | S * | 5/2010  | Smith et al. | ..... | D9/516 |
| D628,896 | S * | 12/2010 | Smith et al. | ..... | D9/542 |

\* cited by examiner

*Primary Examiner* — Elizabeth J Oswecki

(74) *Attorney, Agent, or Firm* — Kent M. Walker, Esq.

(57) **CLAIM**

The ornamental design for a beverage container, as shown and described.

**DESCRIPTION**

FIG. 1 is a an upper perspective view of my beverage container, showing my new design;

FIG. 2 is a front elevational view of the design of FIG. 1;

FIG. 3 is a rear elevational view of the design of FIG. 1;

FIG. 4 is a left side elevational view of the design of FIG. 1,

the right side elevational view being a mirror image thereof;

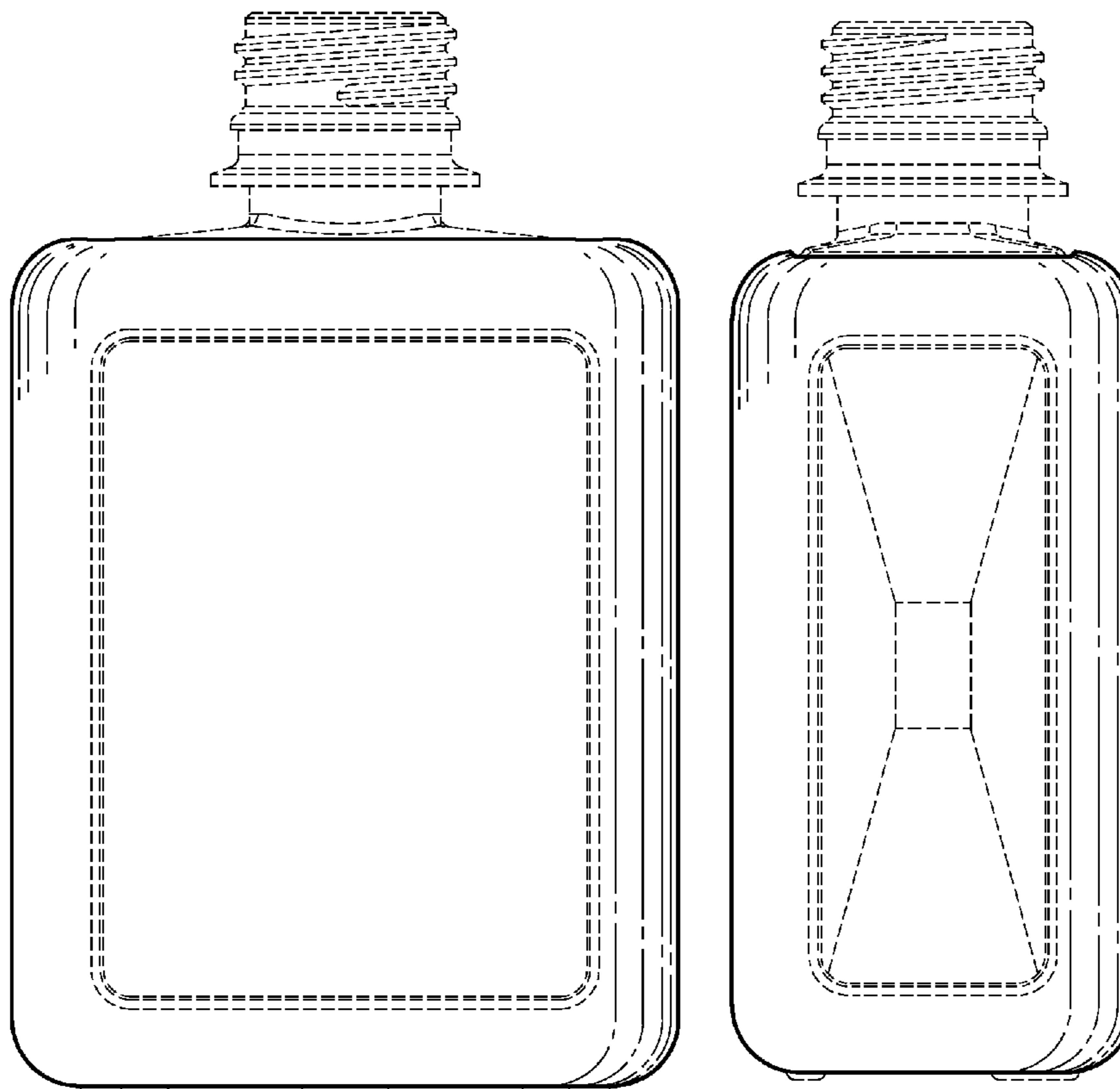
FIG. 5 is a top elevational view of the design of FIG. 1; and,

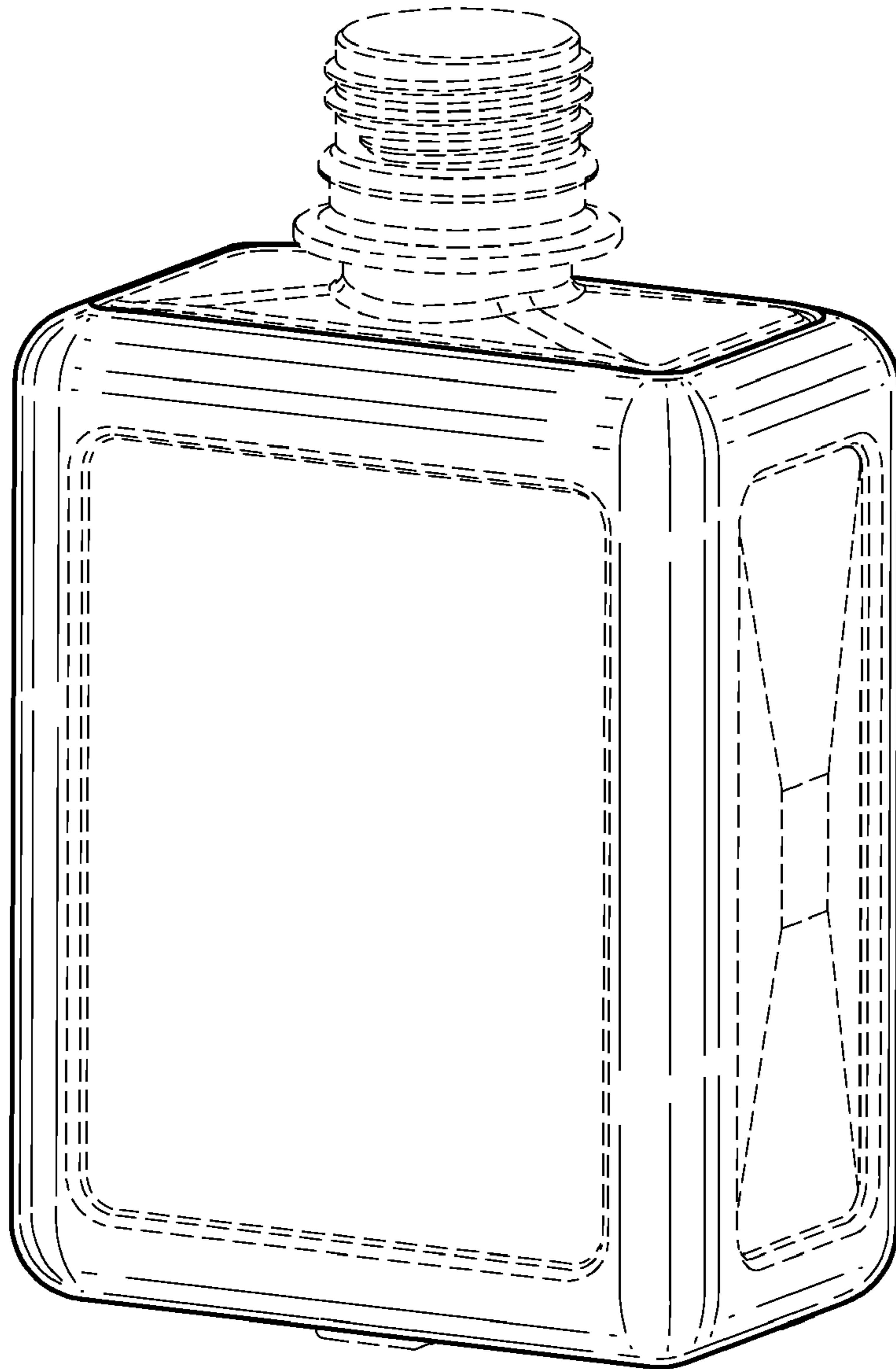
FIG. 6 is a bottom elevational view of the design of FIG. 1.

In the drawings, the broken lines in FIGS. 1-6 depict portions

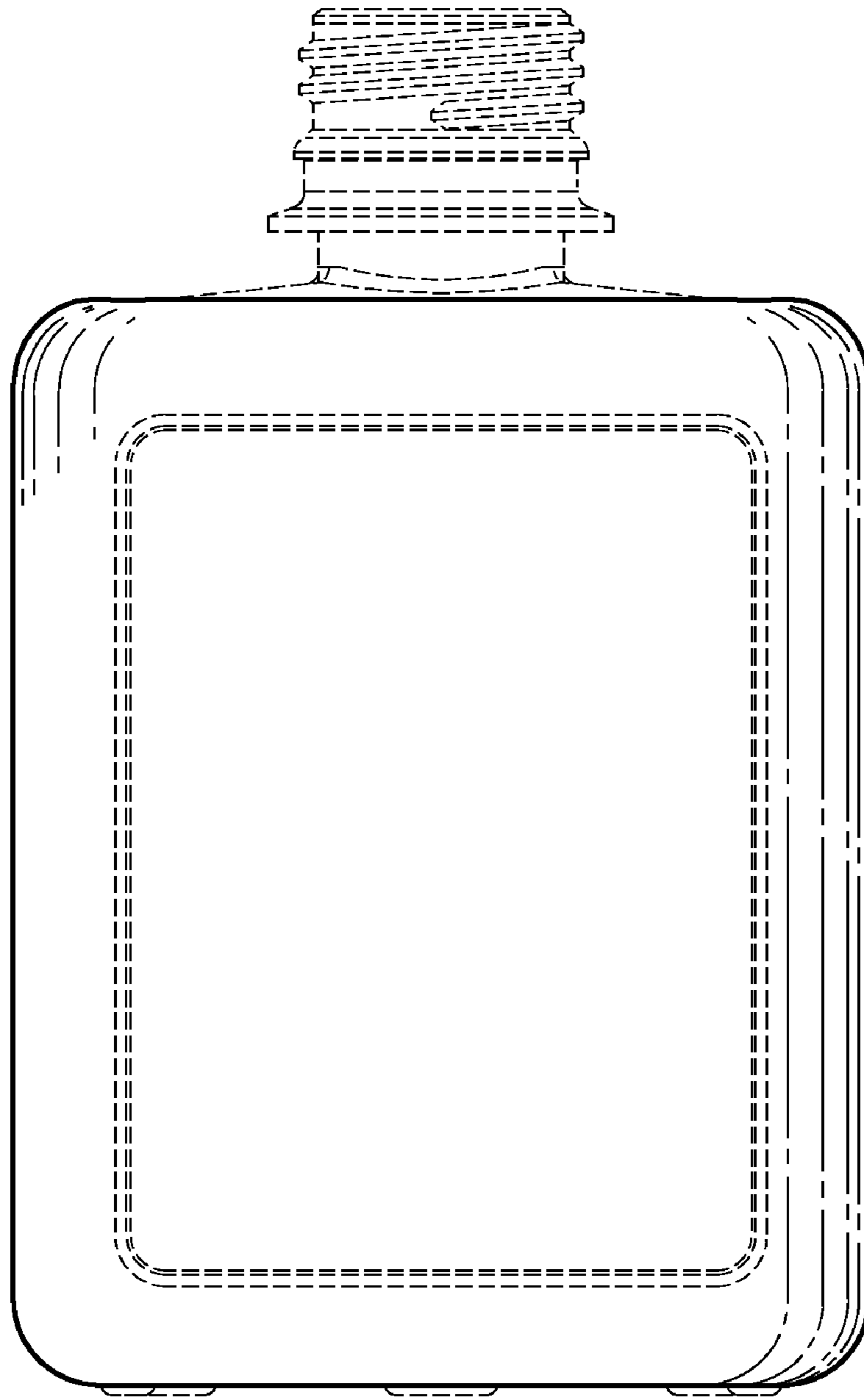
of the design that form no part of the claim.

**1 Claim, 5 Drawing Sheets**

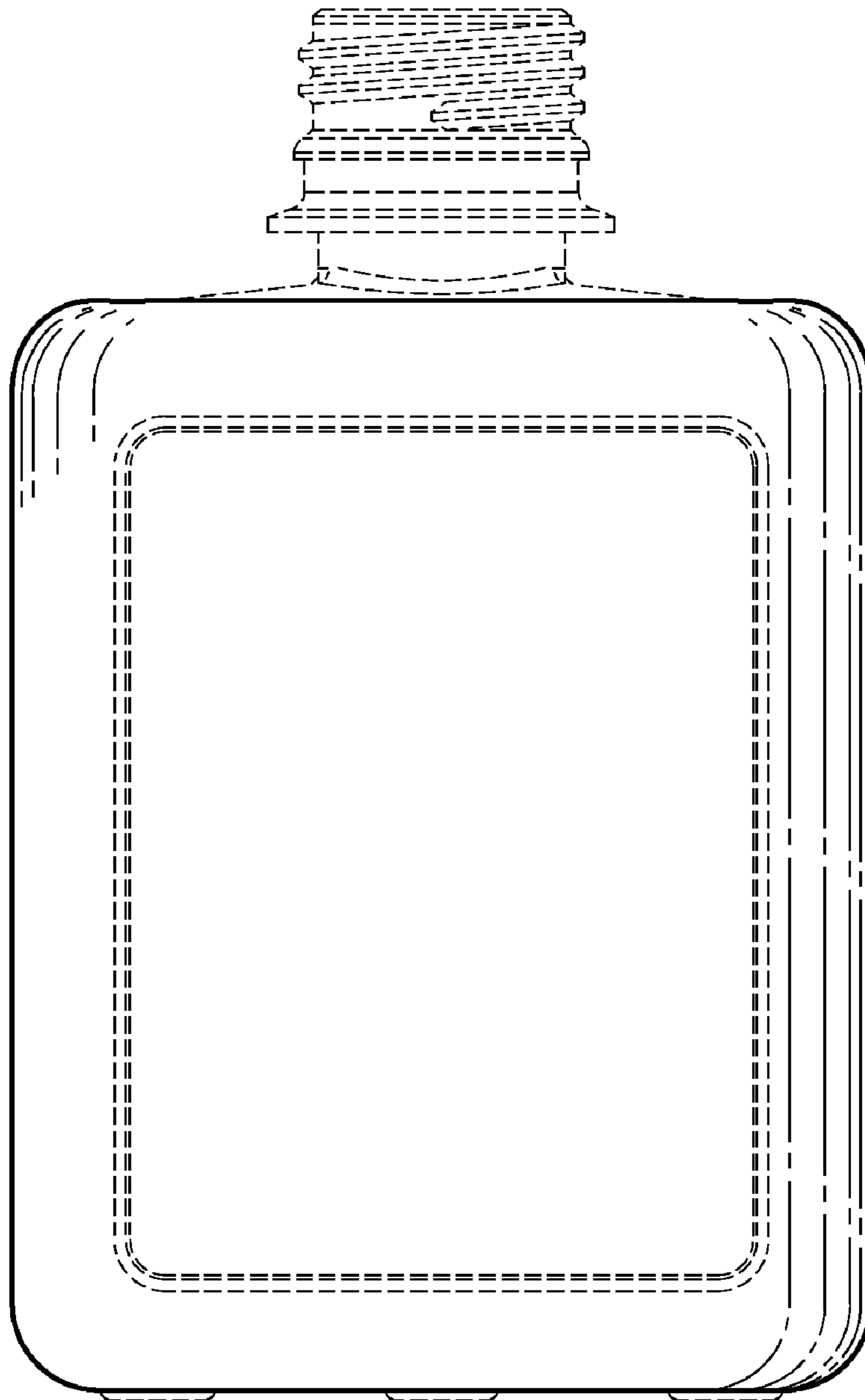




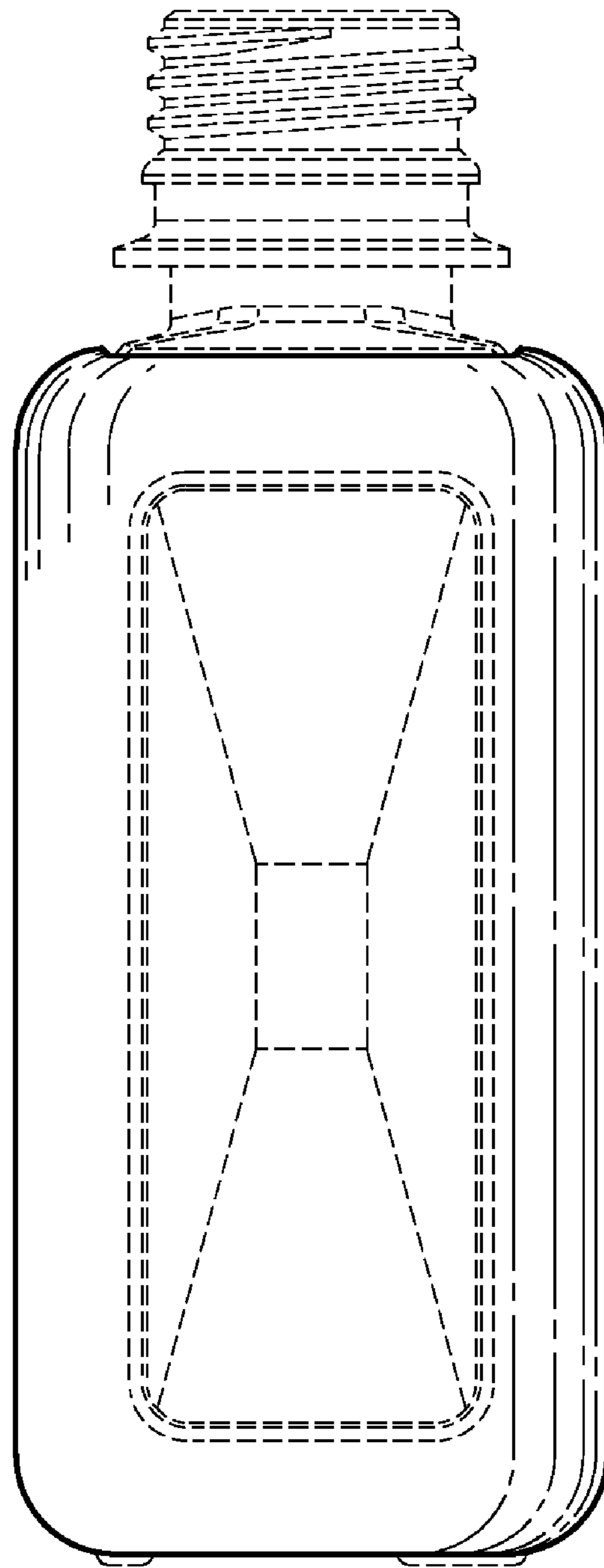
**FIG. 1**



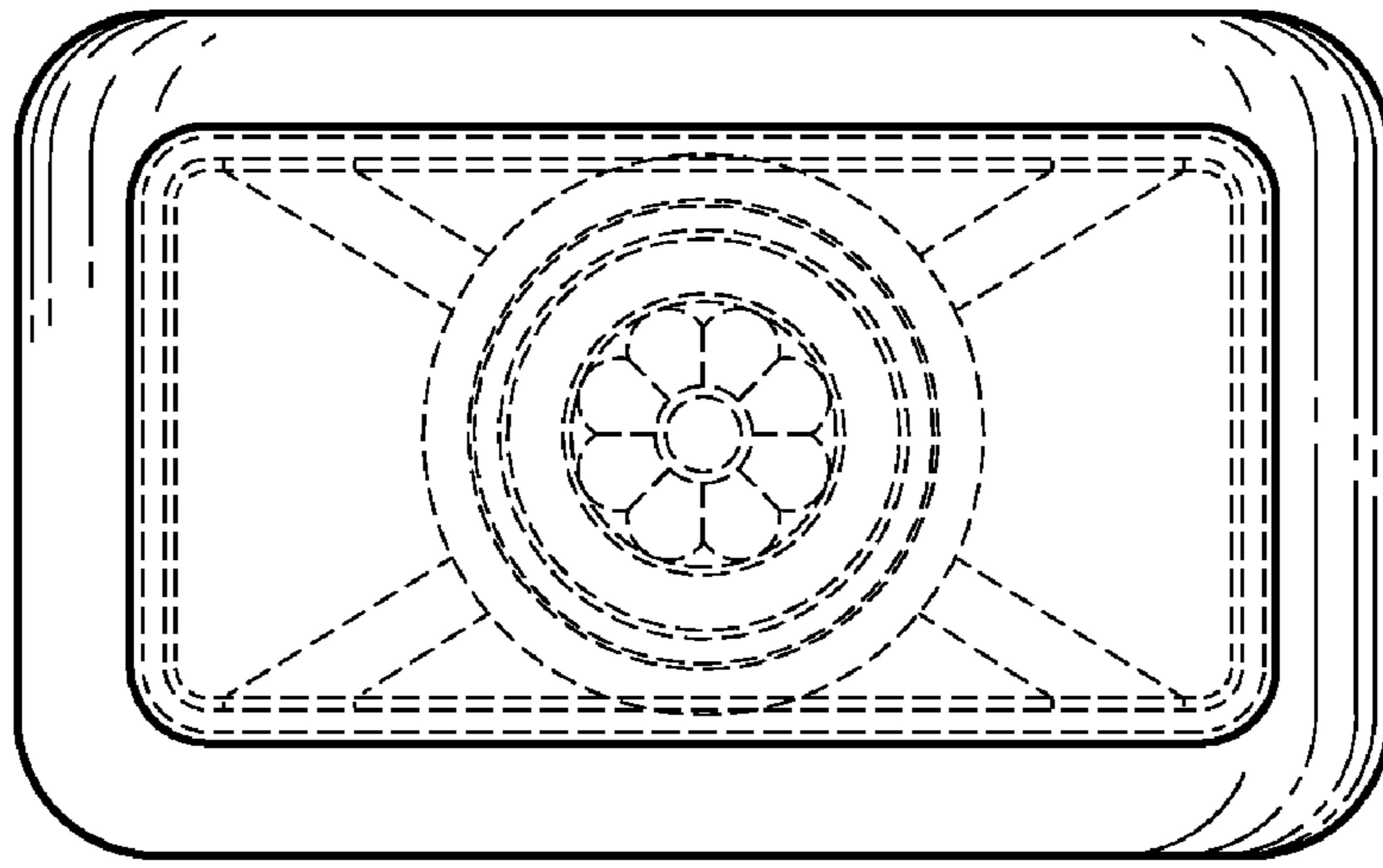
**FIG. 2**



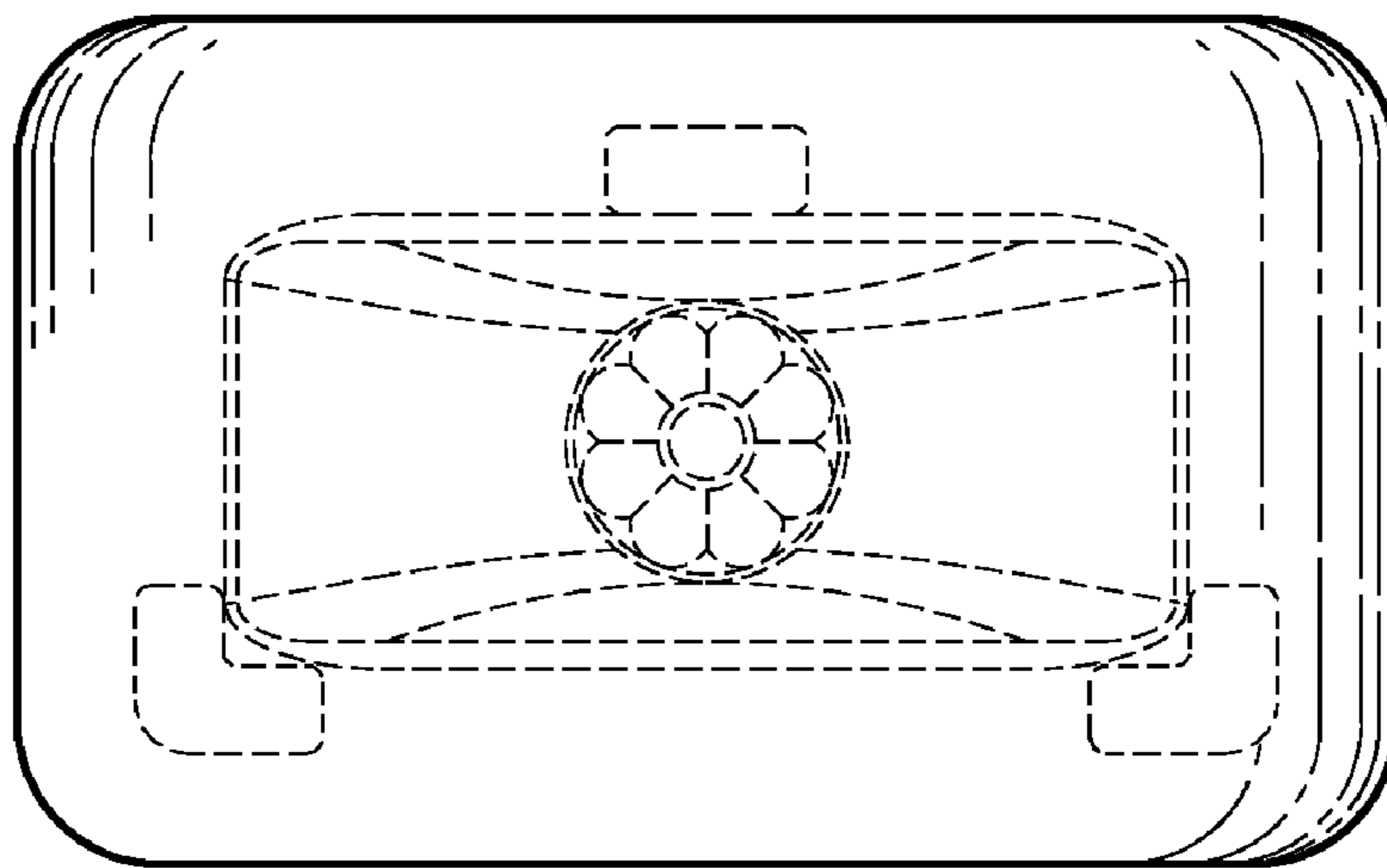
**FIG. 3**



**FIG. 4**



**FIG. 5**



**FIG. 6**