



US00D665236S

(12) **United States Design Patent**  
**Zemel**

(10) **Patent No.:** **US D665,236 S**  
(45) **Date of Patent:** **\*\* Aug. 14, 2012**

(54) **HAMBURGER PRESS**

(75) Inventor: **Marc Zemel**, Melville, NY (US)  
(73) Assignee: **Mr. BAR-B-Q-, Inc.**, Old Bethpage, NY (US)  
(\*\*) Term: **14 Years**

(21) Appl. No.: **29/408,583**  
(22) Filed: **Dec. 14, 2011**

(51) **LOC (9) Cl.** ..... **07-04**  
(52) **U.S. Cl.** ..... **D7/675**  
(58) **Field of Classification Search** ..... D7/672-677,  
D7/354, 357; 99/537; 249/170, 112; 30/114,  
30/152, 301, 314-316, 303, 305, 130, 299  
See application file for complete search history.

(56) **References Cited**

**U.S. PATENT DOCUMENTS**

2,191,921	A	2/1940	Ziringer	
D155,422	S	10/1949	Henderson	
2,722,713	A	11/1955	Oestermeyer	
D206,606	S	1/1967	Brown	
D226,959	S	* 5/1973	Pasquale	D7/676
D226,960	S	* 5/1973	Pasquale	D7/672
3,780,978	A	* 12/1973	Proul	249/135
D234,113	S	1/1975	Wright	
D236,312	S	8/1975	Brown	
3,934,308	A	* 1/1976	Neri	425/409
D245,827	S	9/1977	Korpi	
4,106,162	A	8/1978	Fournier	
D263,398	S	* 3/1982	Tiller	D15/90
D282,136	S	* 1/1986	Skermetta	D7/675
D282,893	S	* 3/1986	Daenen	D7/676
D333,759	S	* 3/1993	Ferrin	D7/672
D352,206	S	11/1994	Davis	
D353,968	S	1/1995	Cock	
D369,948	S	5/1996	Tobiasz	
D377,138	S	1/1997	Angelo	
D414,075	S	9/1999	Mishan	
D417,368	S	* 12/1999	O'Neill	D7/606

(Continued)

**OTHER PUBLICATIONS**

U.S. Appl. No. 29/408,586, Marc Zemel.

*Primary Examiner* — Terry Wallace

(74) *Attorney, Agent, or Firm* — Carter, DeLuca, Farrell & Schmidt LLP

(57) **CLAIM**

The ornamental design for a hamburger press, as shown and described.

**DESCRIPTION**

FIG. 1 is a front side perspective view of a hamburger press in accordance with the present design;  
FIG. 2 is a bottom side perspective view thereof;  
FIG. 3 is a top plan view thereof;  
FIG. 4 is a bottom plan view thereof;  
FIG. 5 is a front elevational view thereof;  
FIG. 6 is a rear elevational view thereof;  
FIG. 7 is a right side elevational view thereof;  
FIG. 8 is left side elevational view thereof;  
FIG. 9 is an exploded isometric front perspective view thereof;  
FIG. 10 is an exploded isometric bottom perspective view thereof;  
FIG. 11 is a top plan view of the exploded isometric views of FIGS. 9 and 10;  
FIG. 12 is a bottom plan view of the exploded isometric views of FIGS. 9 and 10;  
FIG. 13 is an exploded isometric front elevational view thereof;  
FIG. 14 is an exploded isometric rear elevational view thereof;  
FIG. 15 is an exploded isometric right side elevational view thereof; and,  
FIG. 16 is an exploded isometric left side elevational view thereof.  
The stippling in the drawings is for shading purposes only.

**1 Claim, 9 Drawing Sheets**

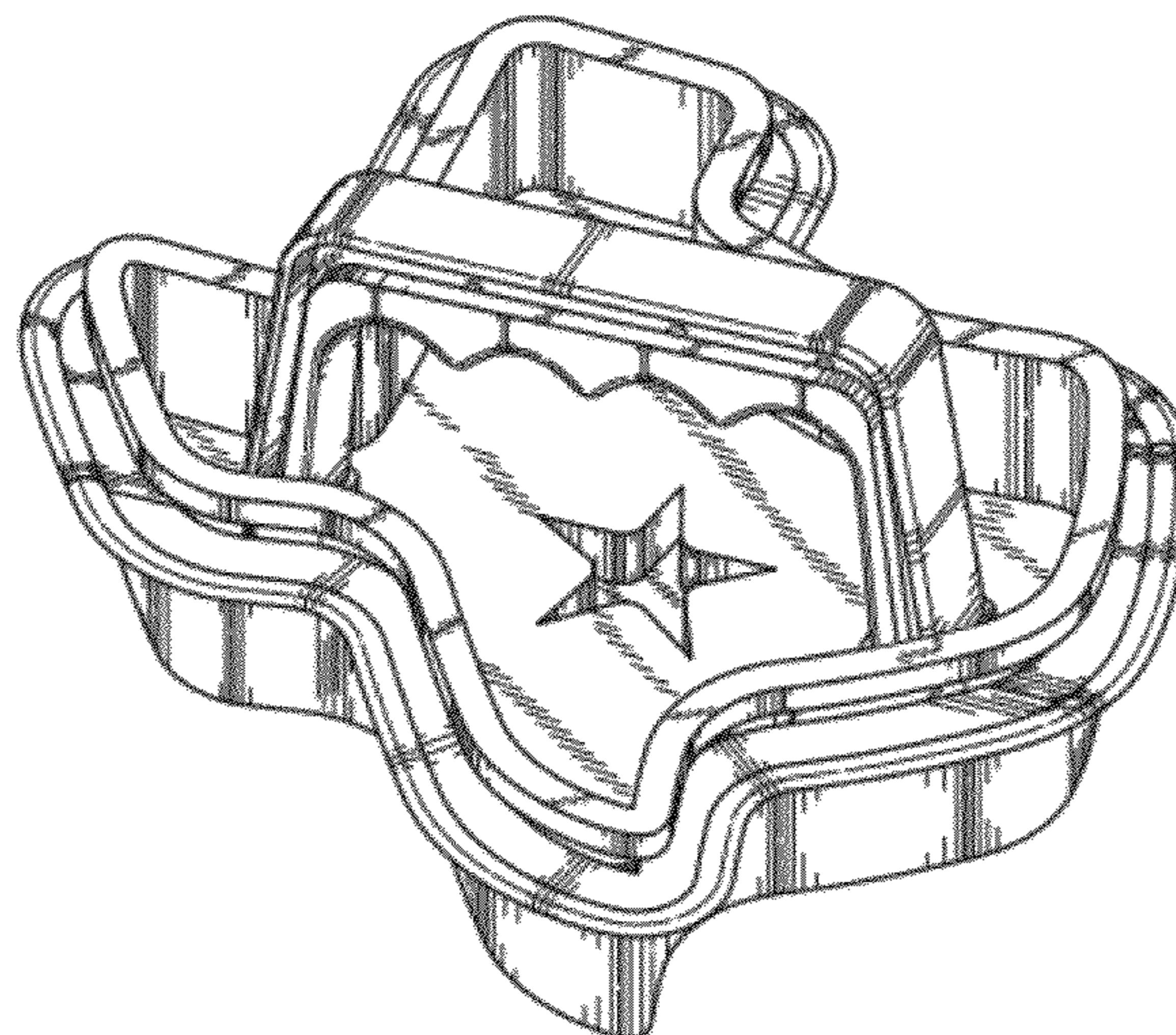

# US D665,236 S

Page 2

---

## U.S. PATENT DOCUMENTS

D433,898 S	*	11/2000	Hunt	.....	D8/38	D621,668 S		8/2010	Zemel	
D556,918 S	*	12/2007	Woodring	.....	D25/113	D653,508 S	*	2/2012	Nguyen	..... D7/675
D575,097 S		8/2008	Courington et al.			2009/0246311 A1	*	10/2009	Hauser	..... 425/519
D595,998 S		7/2009	Hauser							

\* cited by examiner

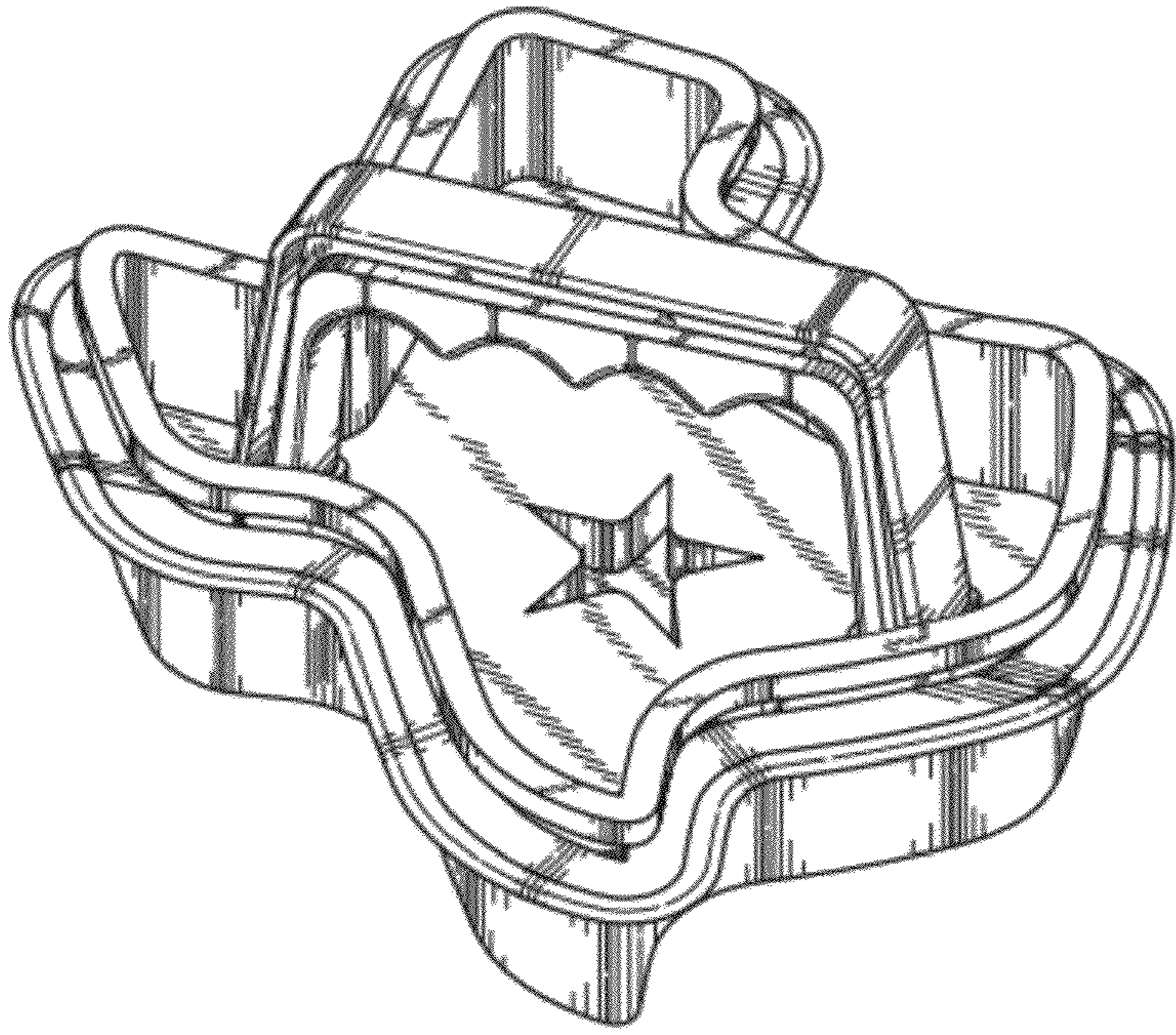

FIG. 1

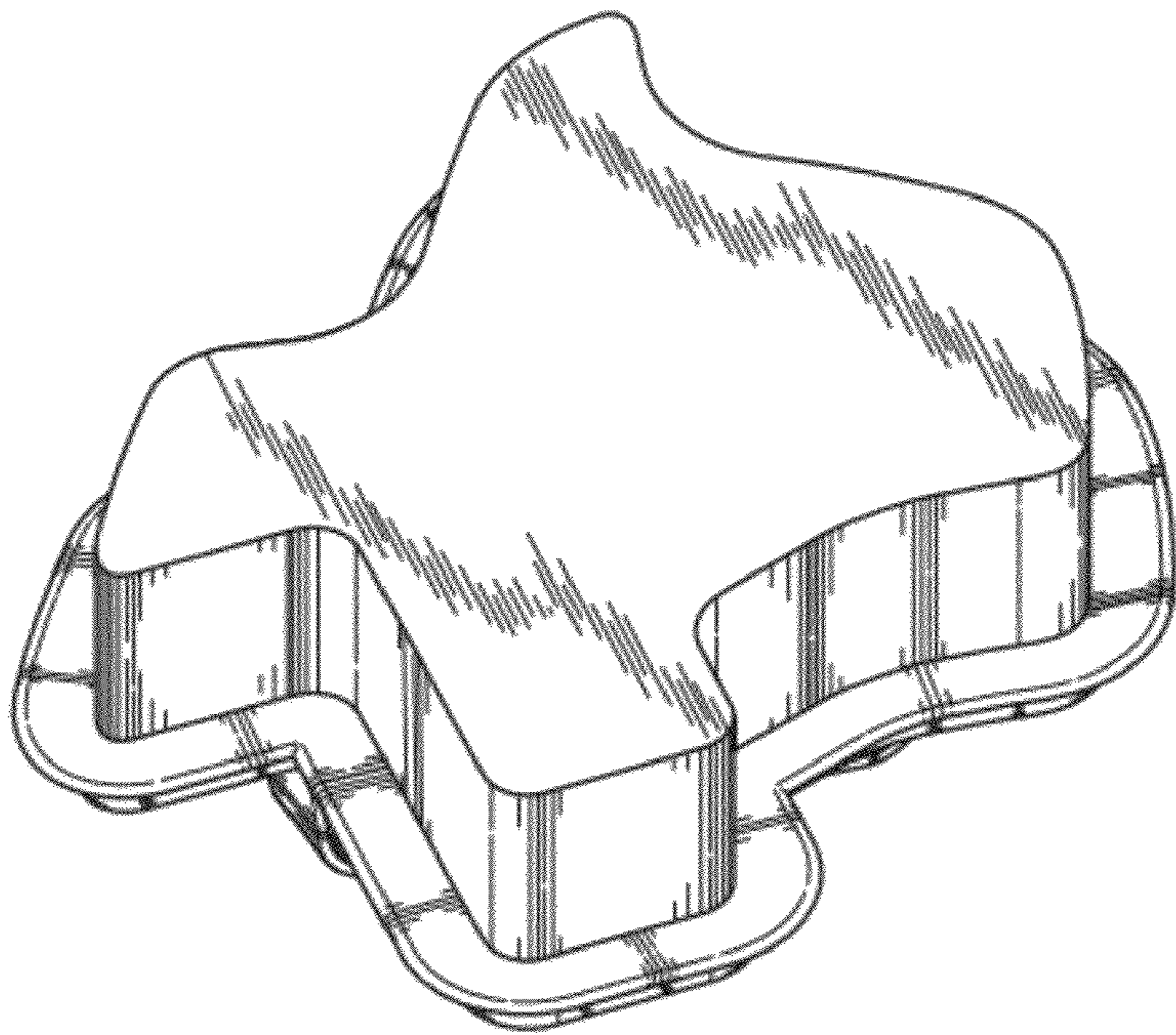

FIG. 2

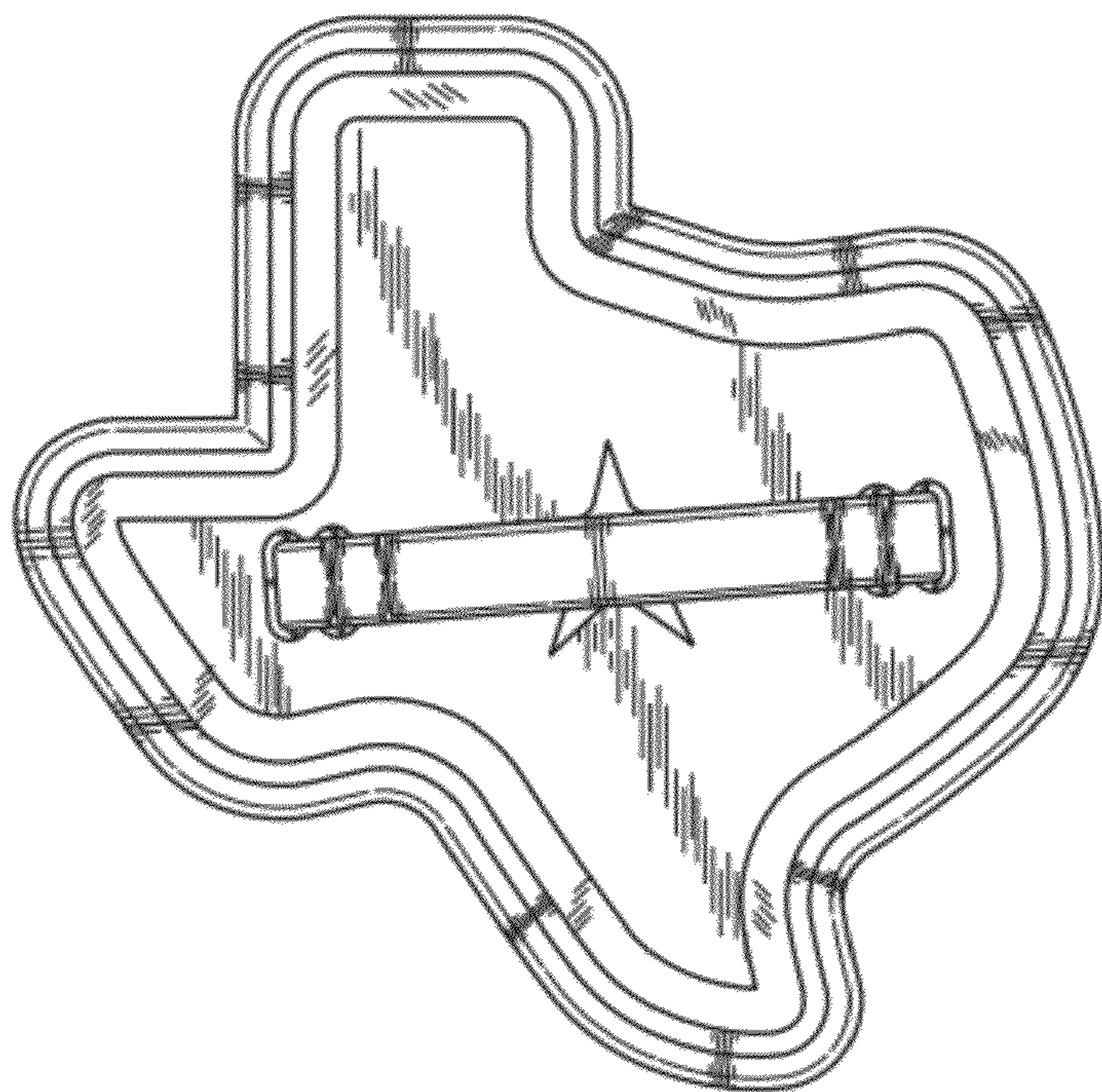

FIG. 3

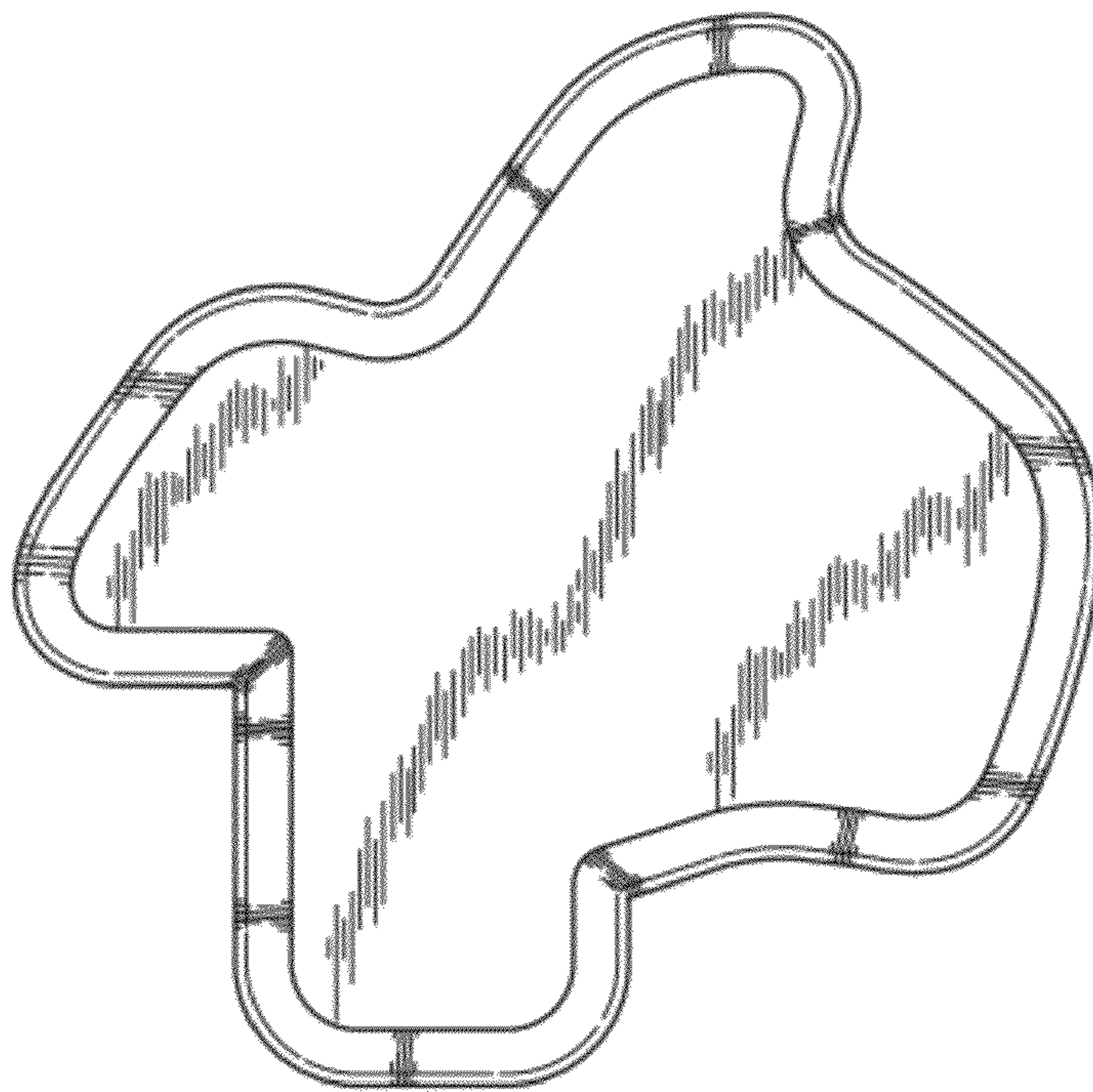

FIG. 4

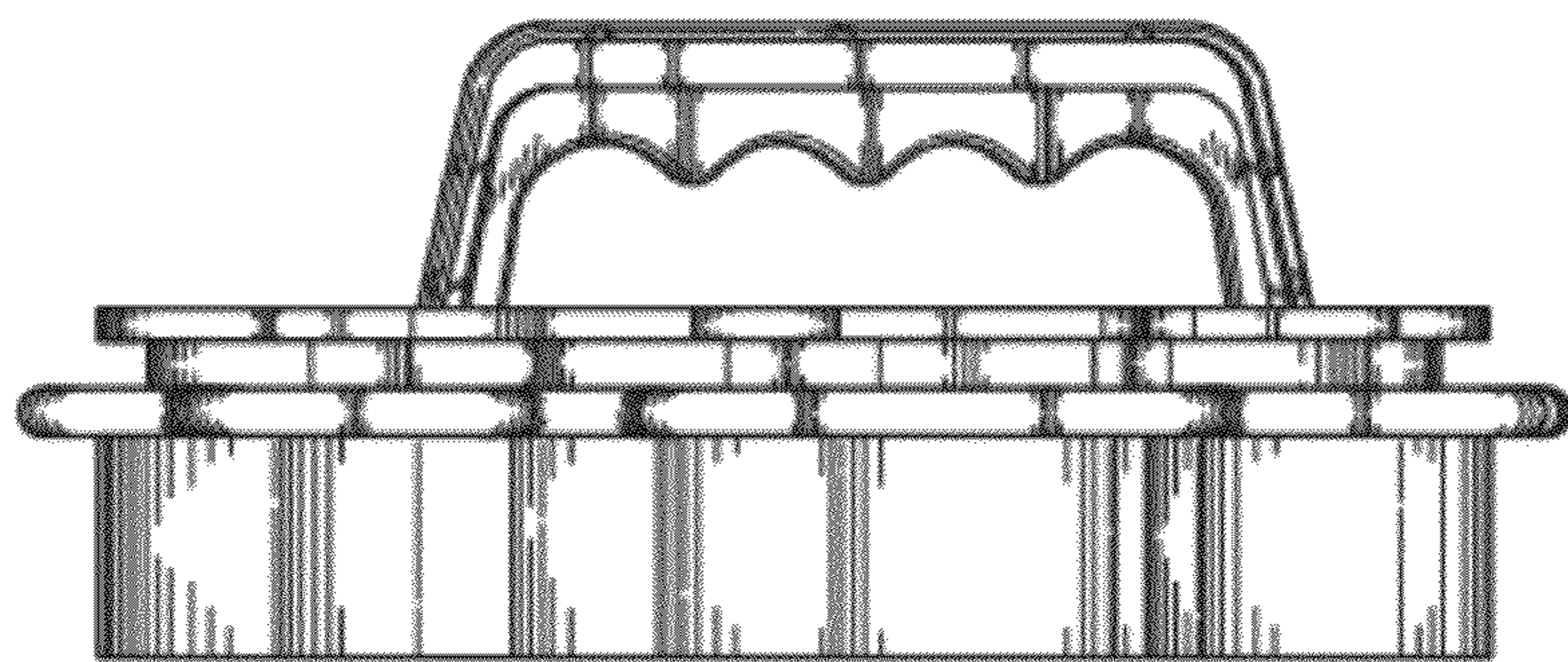

FIG. 5

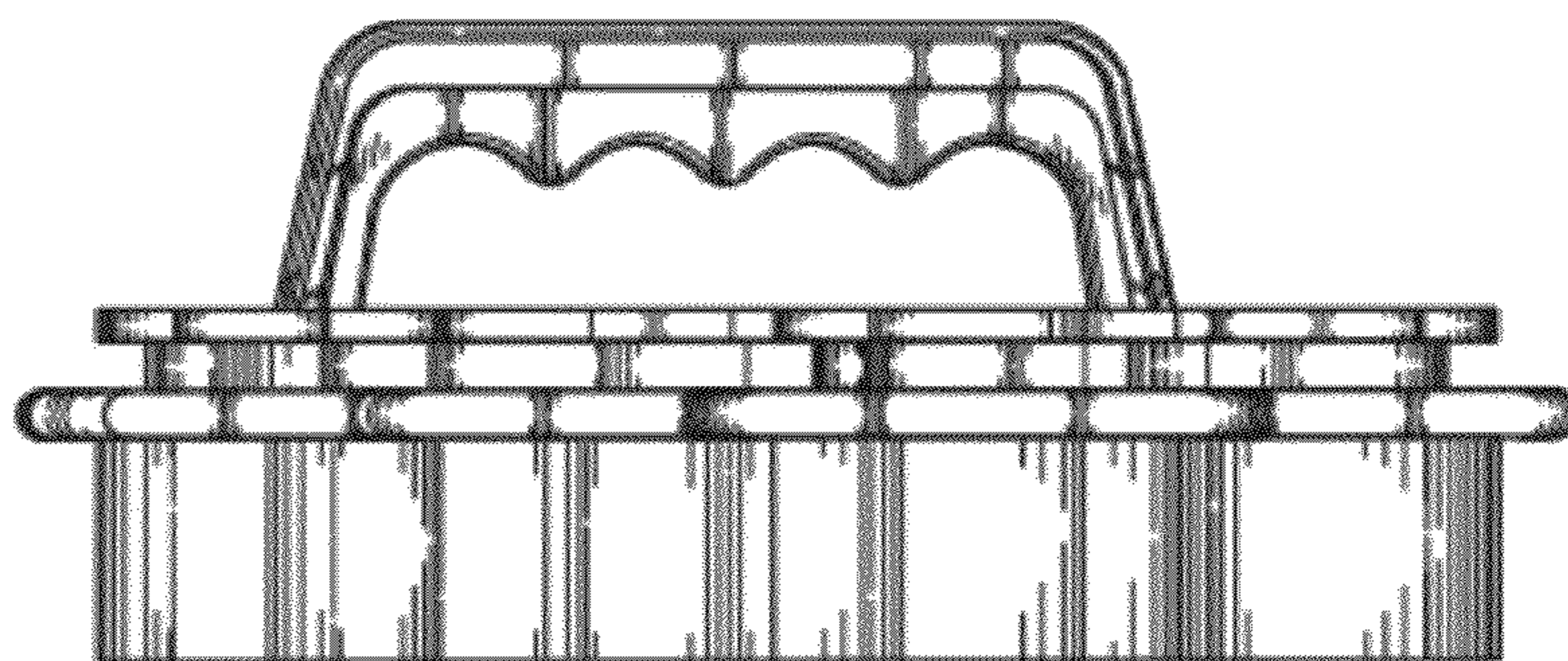

FIG. 6

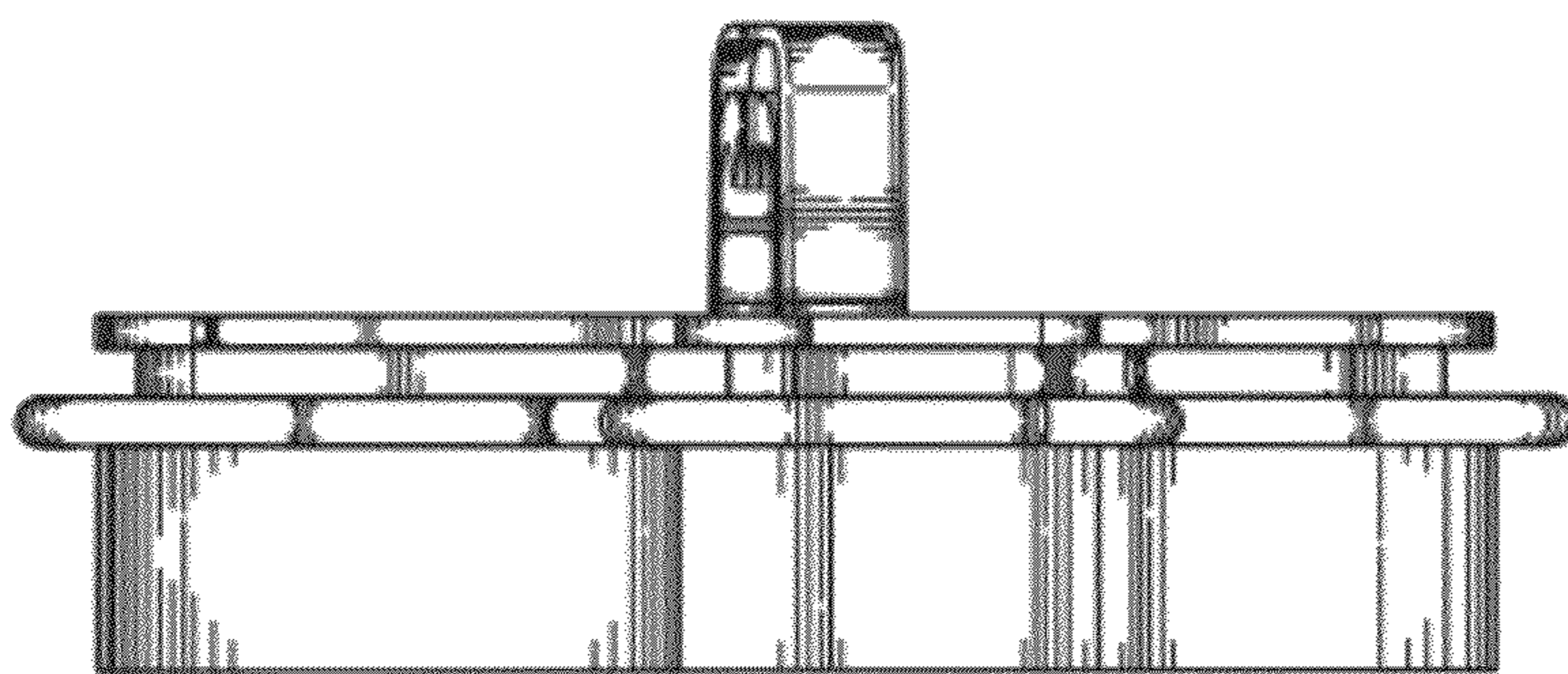

FIG. 7

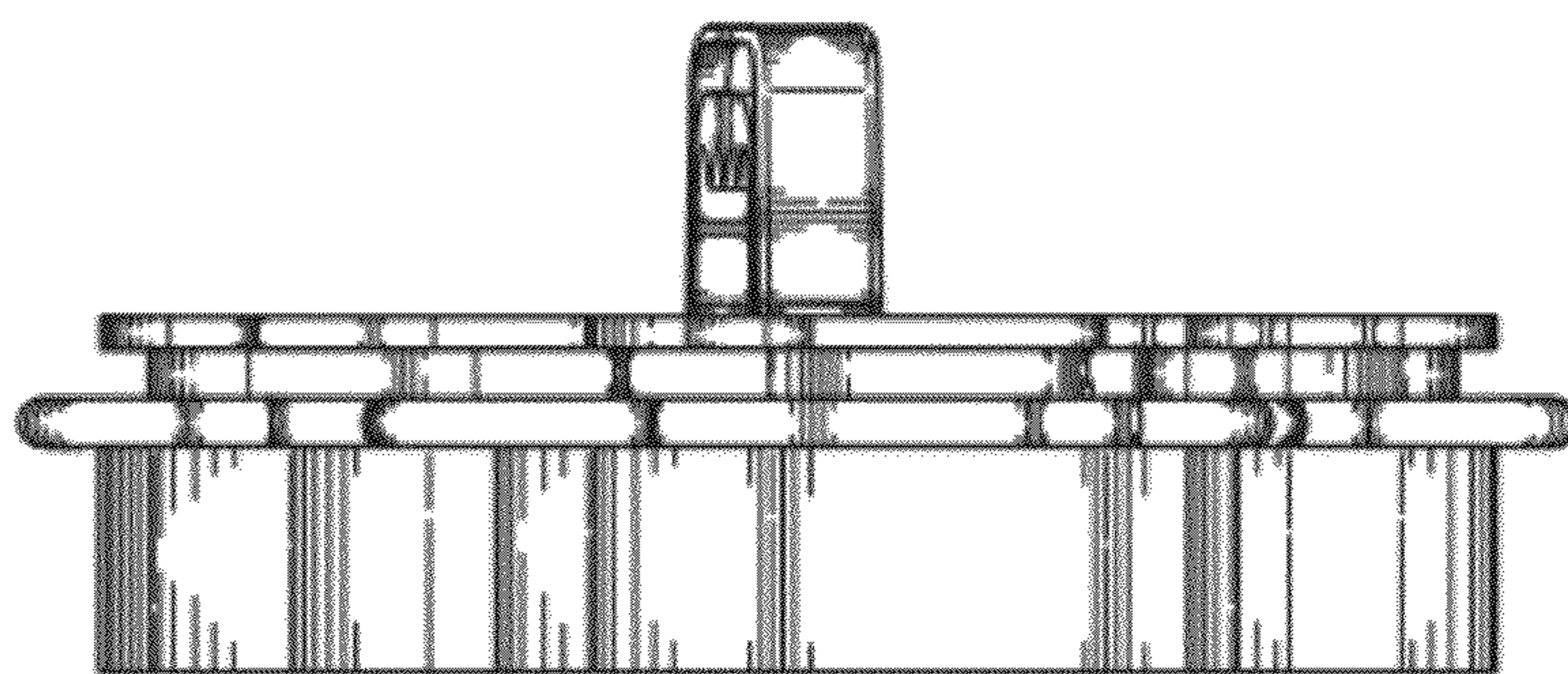

FIG. 8

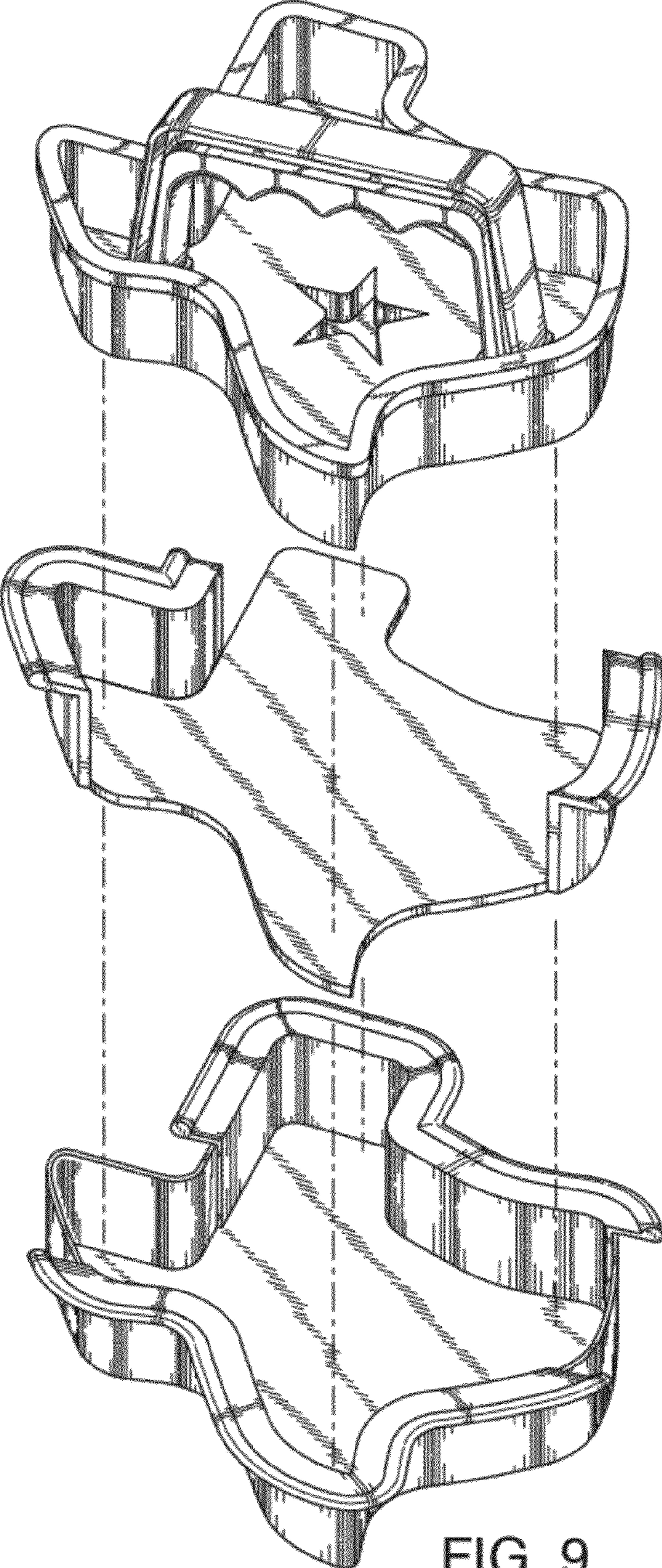

FIG. 9

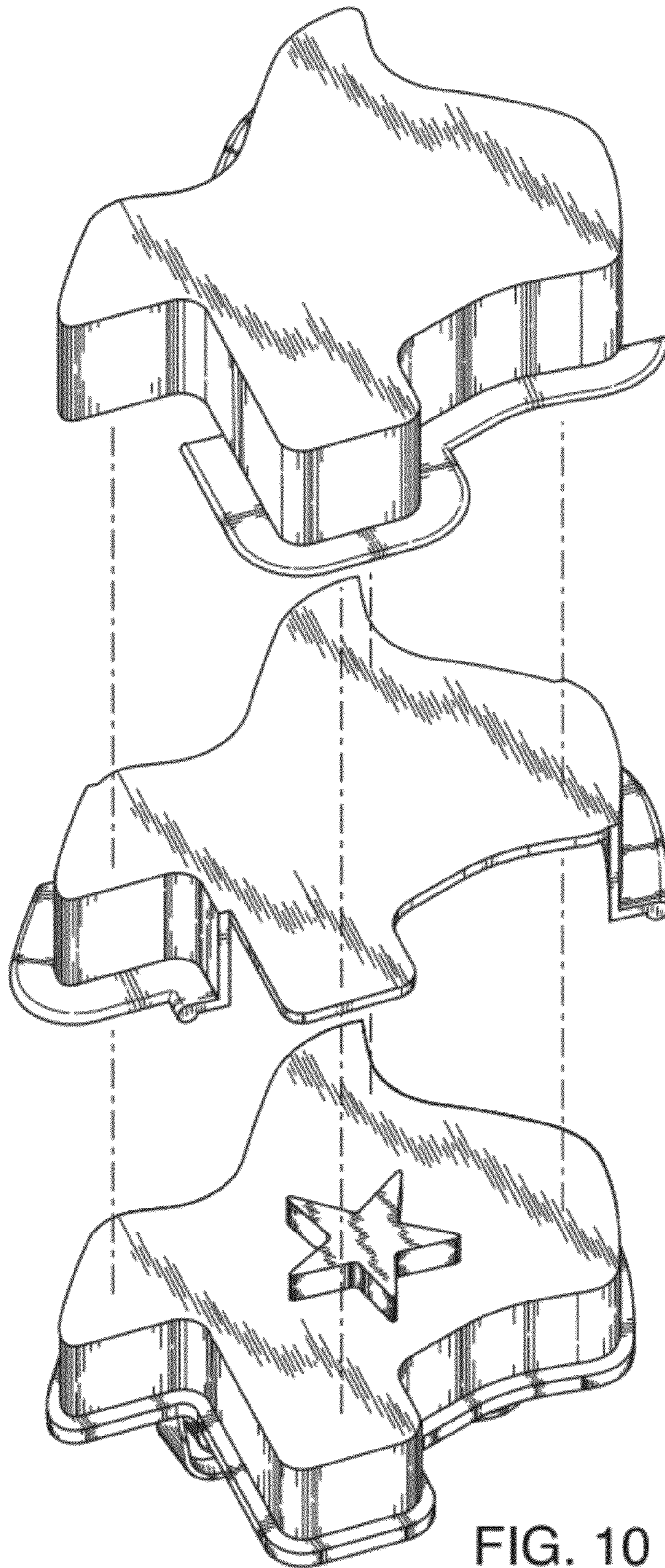

FIG. 10



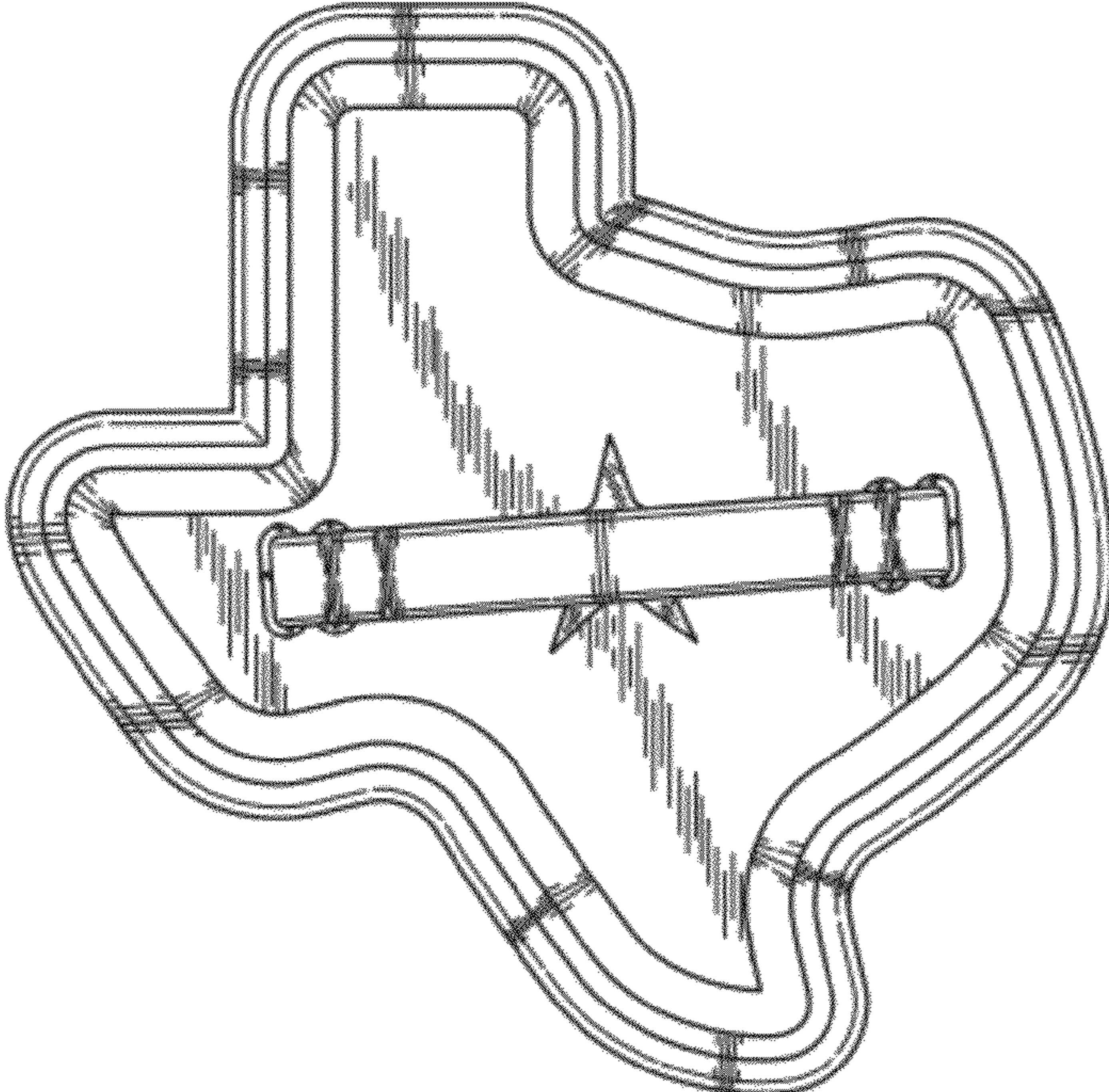

FIG. 11

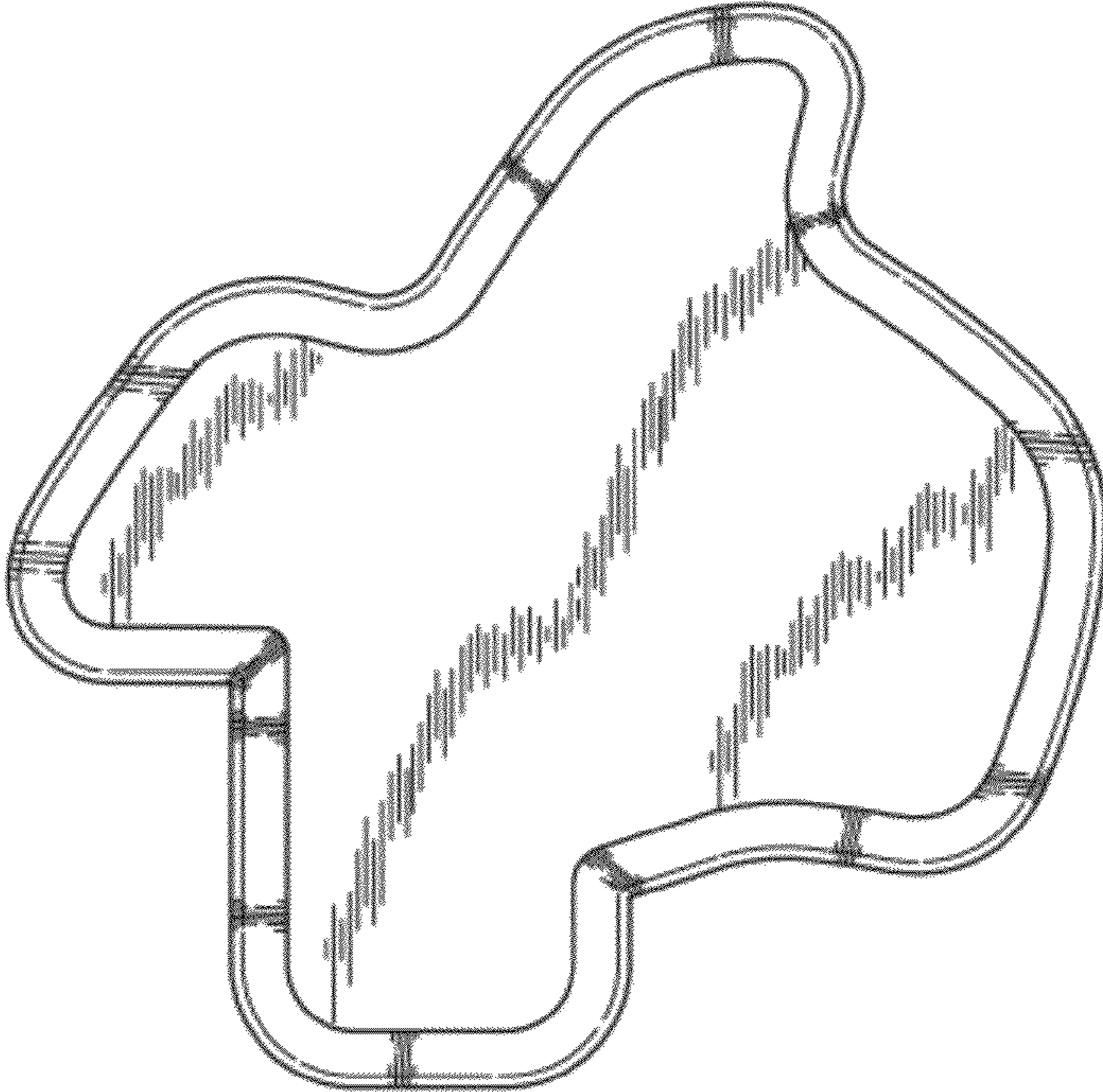

FIG. 12

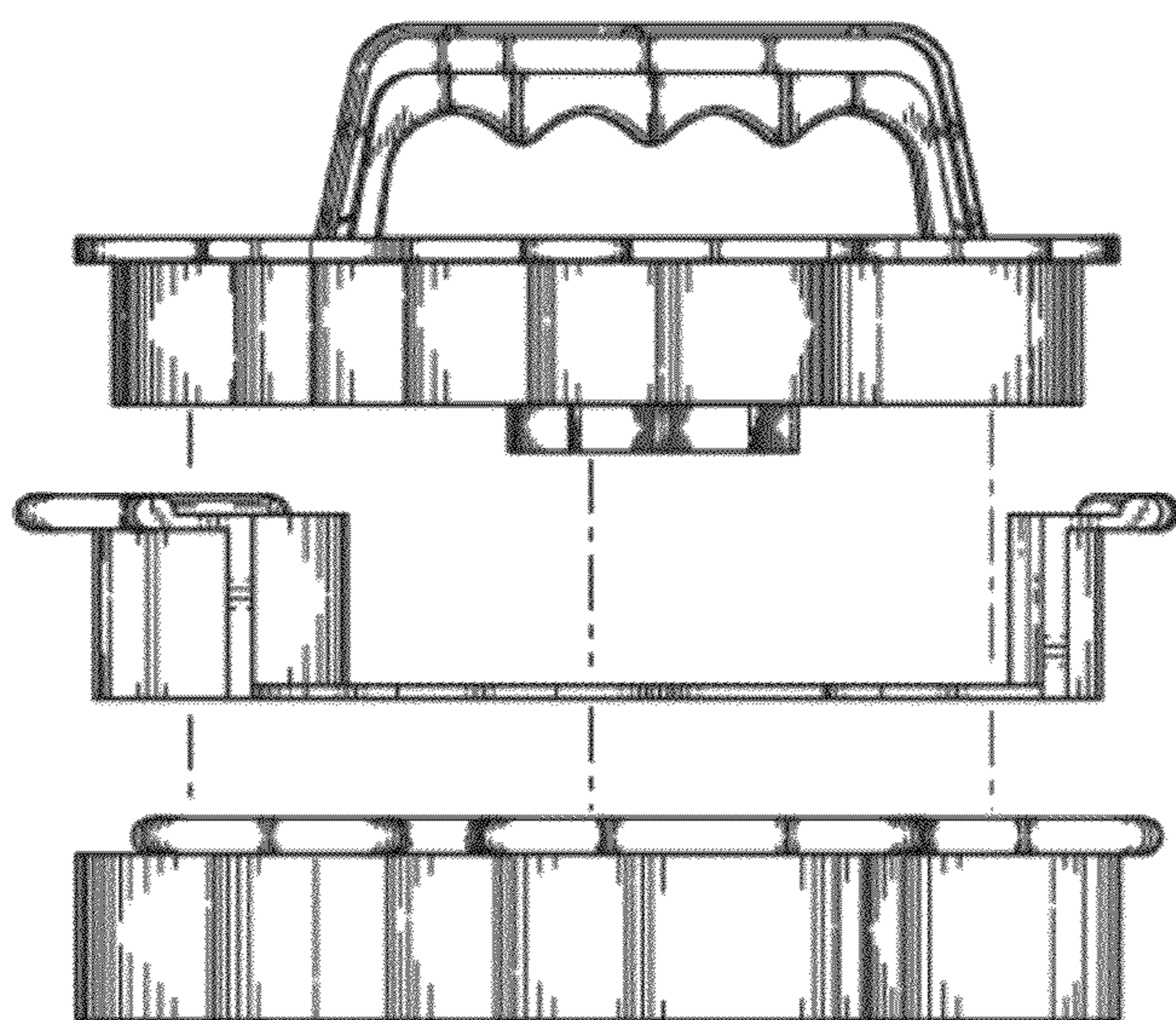

FIG. 13

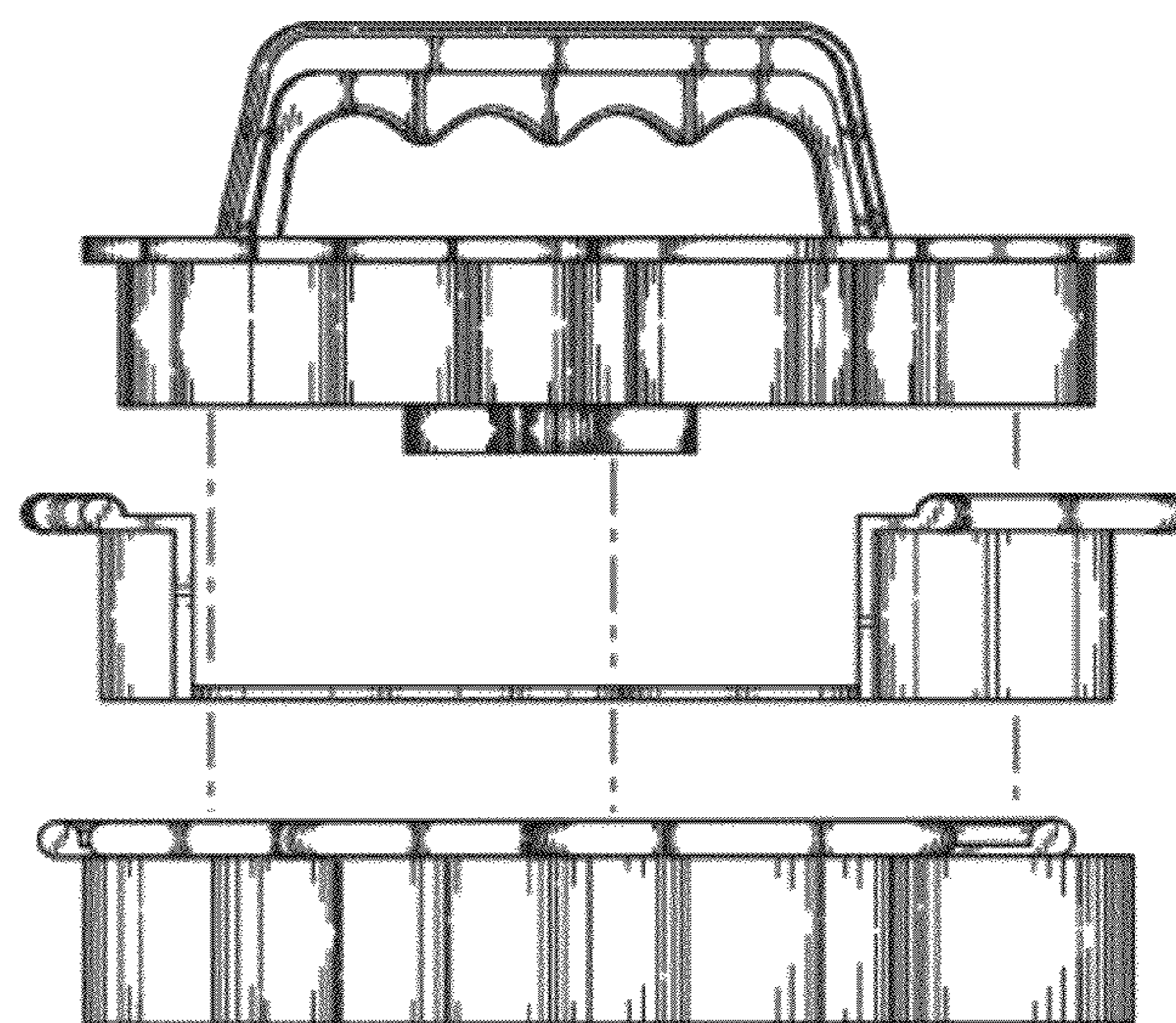

FIG. 14

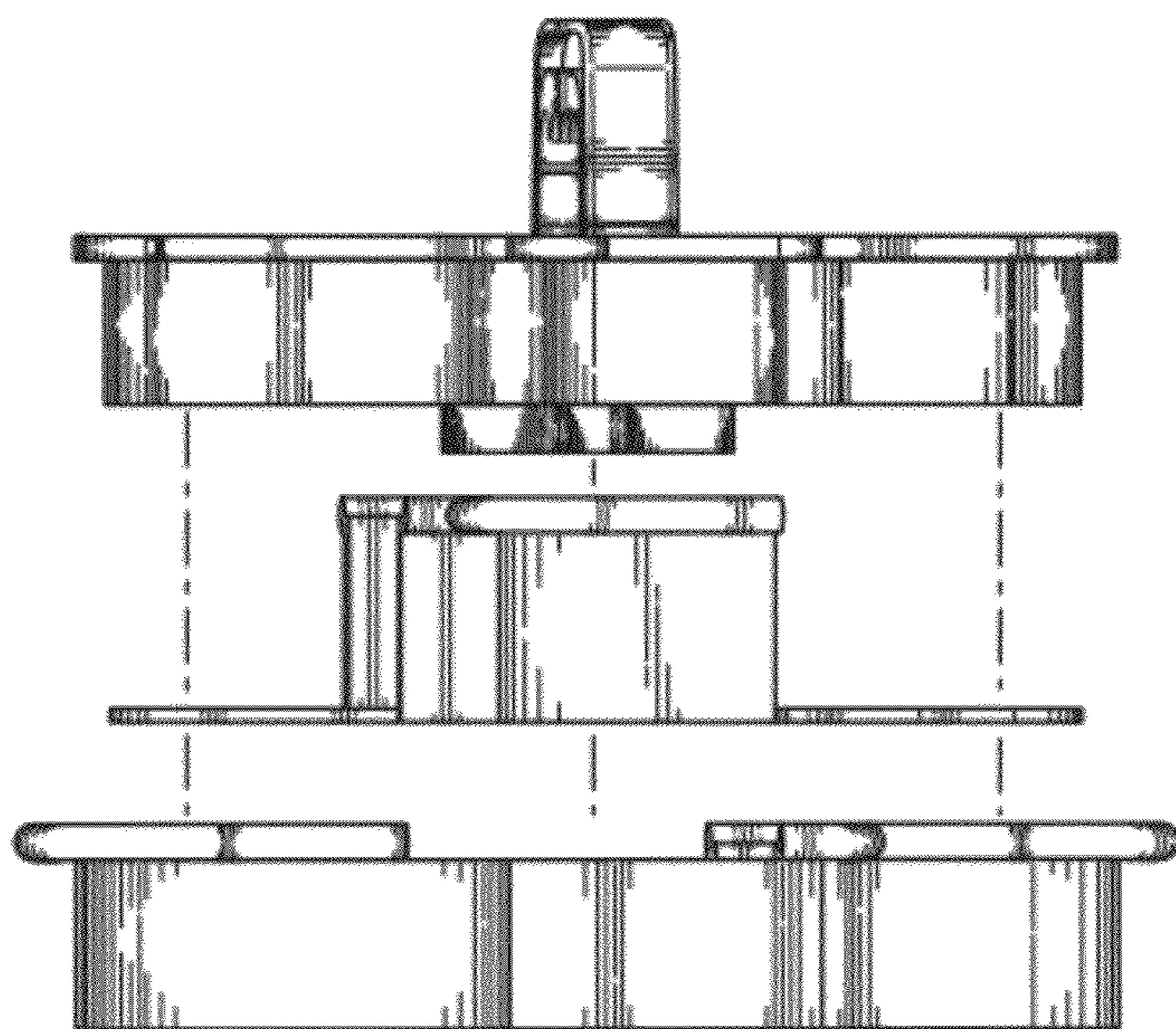

FIG. 15

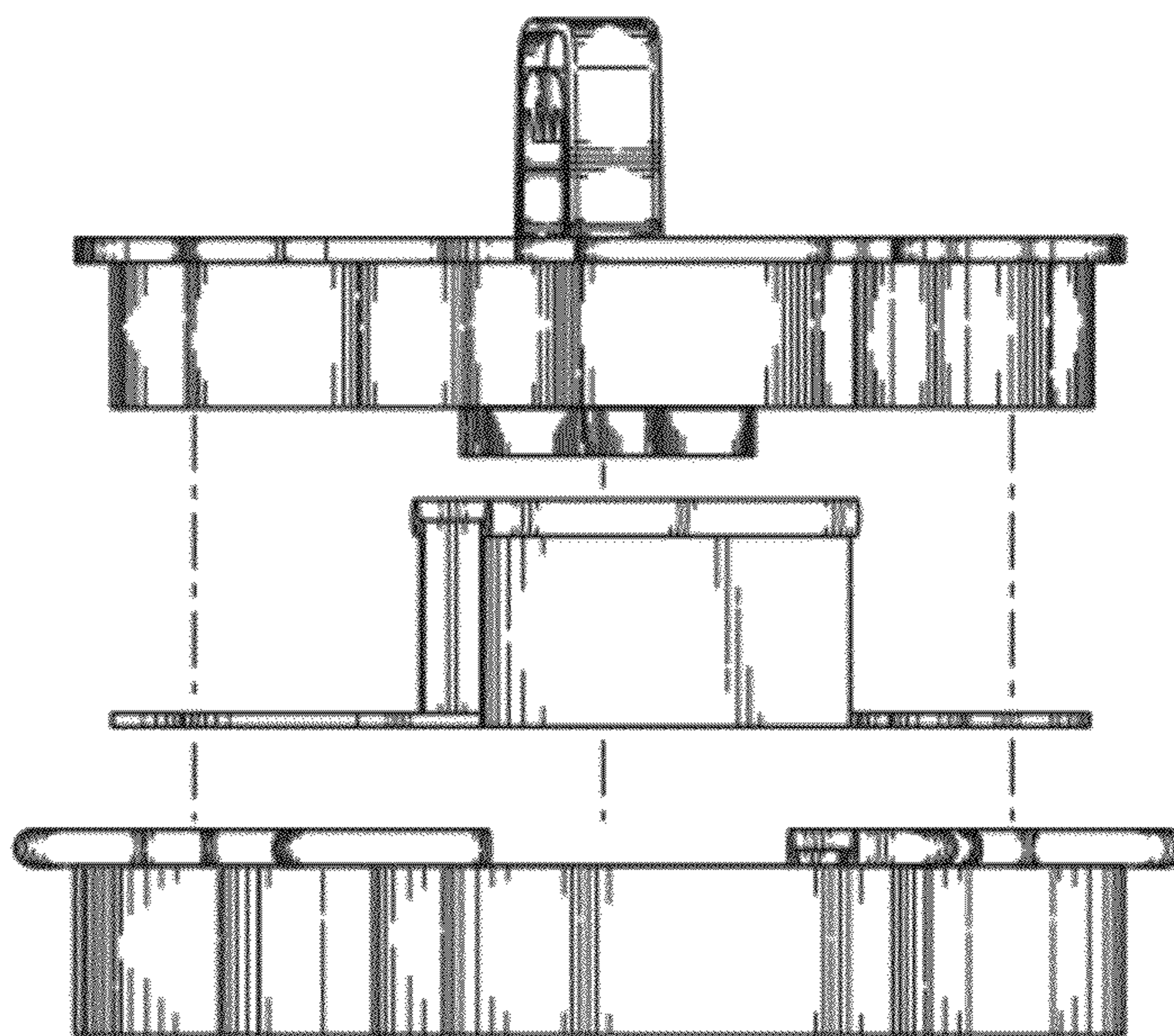

FIG. 16