

US00D665219S

(12) **United States Design Patent**
Ohmae et al.

(10) **Patent No.:** **US D665,219 S**

(45) **Date of Patent:** **** *Aug. 14, 2012**

(54) **MICROWAVE OVEN**

(75) Inventors: **Ken Ohmae**, Shiga (JP); **Muneyuki Nagai**, Nara (JP); **Haruka Ohno**, Kyoto (JP)

(73) Assignee: **Panasonic Corporation**, Osaka (JP)

(*) Notice: This patent is subject to a terminal disclaimer.

(**) Term: **14 Years**

(21) Appl. No.: **29/392,423**

(22) Filed: **May 20, 2011**

(51) **LOC (9) Cl.** **07-02**

(52) **U.S. Cl.** **D7/351**

(58) **Field of Classification Search** D7/350.1, D7/350.3, 350.4, 351, 402, 403, 405, 406; 219/756, 757, 758, 391; 126/19 M, 21 A, 126/275 E; 99/352

See application file for complete search history.

(56) **References Cited**

U.S. PATENT DOCUMENTS

D437,179 S *	2/2001	Ozaki et al.	D7/351
D455,931 S	4/2002	Mimura et al.		
D476,521 S *	7/2003	Fukuda et al.	D7/351
D478,465 S *	8/2003	Kanza	D7/351

D522,801 S *	6/2006	Lee	D7/351
D531,447 S *	11/2006	Lee et al.	D7/350.4
D532,645 S *	11/2006	Lee	D7/351
D545,611 S *	7/2007	Sakata	D7/351
D561,529 S	2/2008	Suh et al.		
D577,246 S *	9/2008	Kikumoto	D7/351
D579,270 S *	10/2008	Green et al.	D7/405
D583,614 S *	12/2008	Chung et al.	D7/351
D599,163 S *	9/2009	Oomae	D7/351
D632,125 S *	2/2011	Kim et al.	D7/351
D633,326 S *	3/2011	Shin et al.	D7/351

* cited by examiner

Primary Examiner — Ruth McInroy

(74) *Attorney, Agent, or Firm* — Brinks Hofer Gilson & Lione

(57) **CLAIM**

We claim the ornamental design for a microwave oven, as shown and described.

DESCRIPTION

FIG. 1 is a front perspective view of a microwave oven of the present invention;

FIG. 2 is a front view thereof;

FIG. 3 is a rear view thereof;

FIG. 4 is a first side view thereof;

FIG. 5 is a second side view thereof;

FIG. 6 is a top view thereof; and,

FIG. 7 is a bottom view thereof.

1 Claim, 4 Drawing Sheets

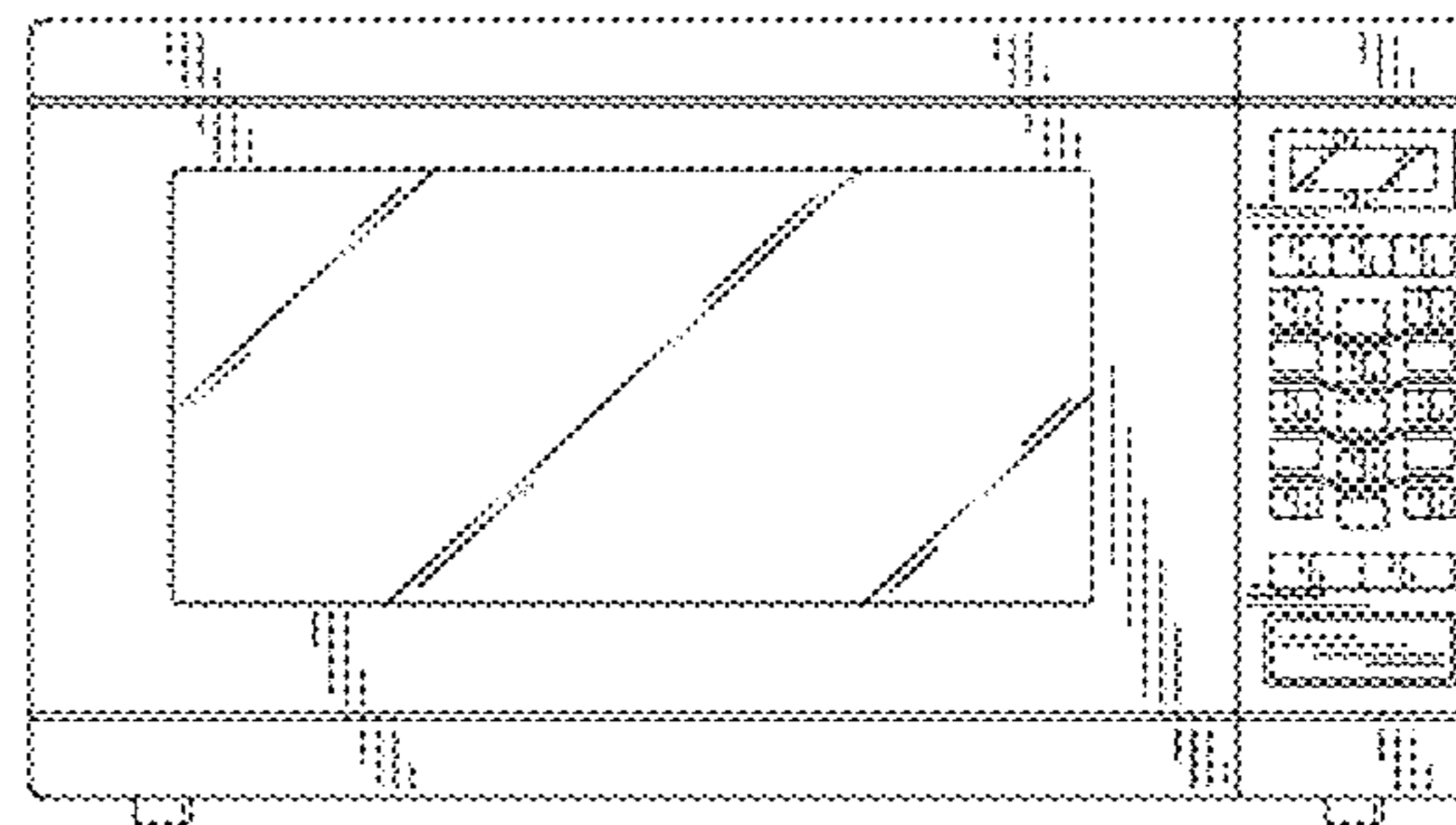
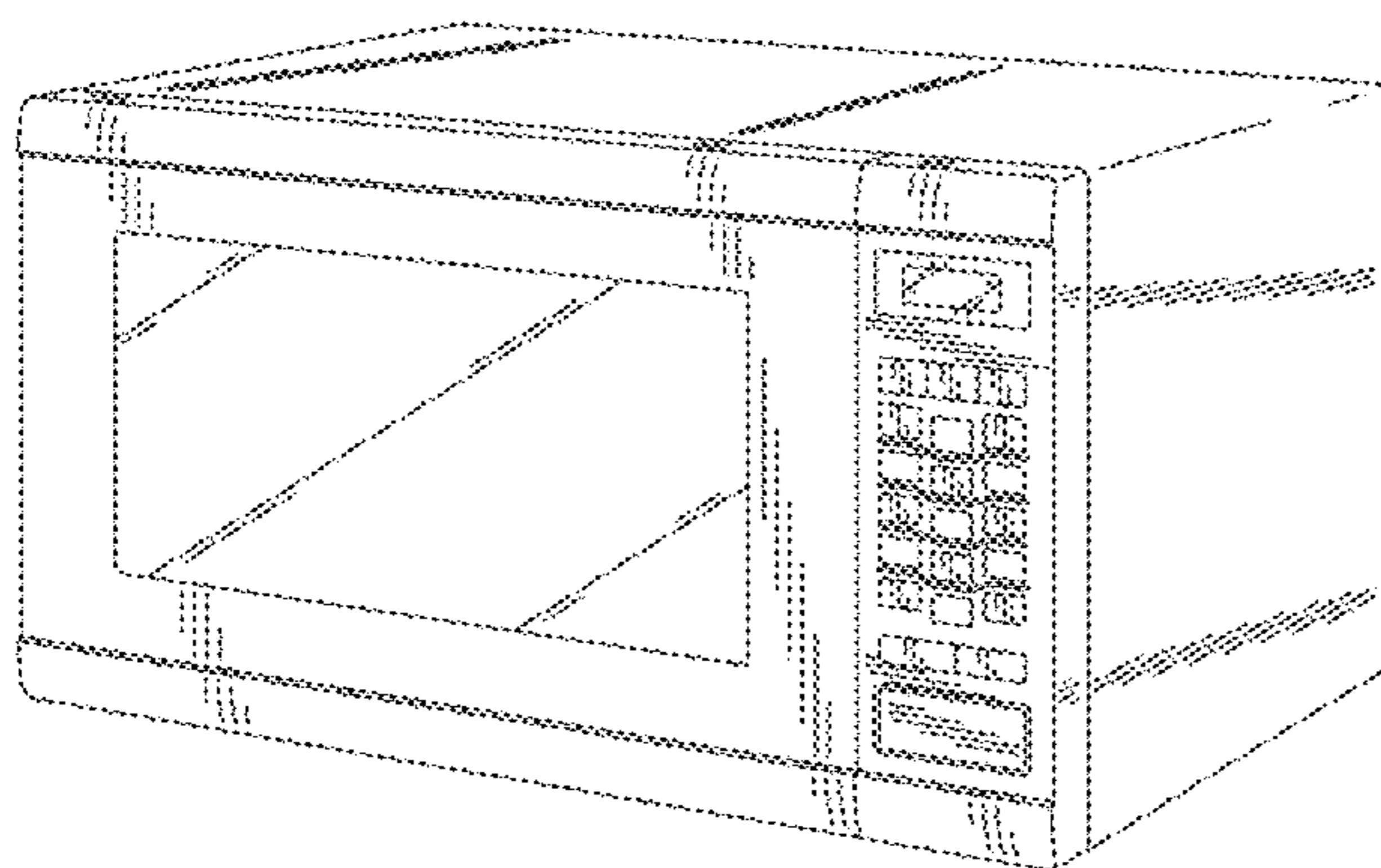

FIG. 1

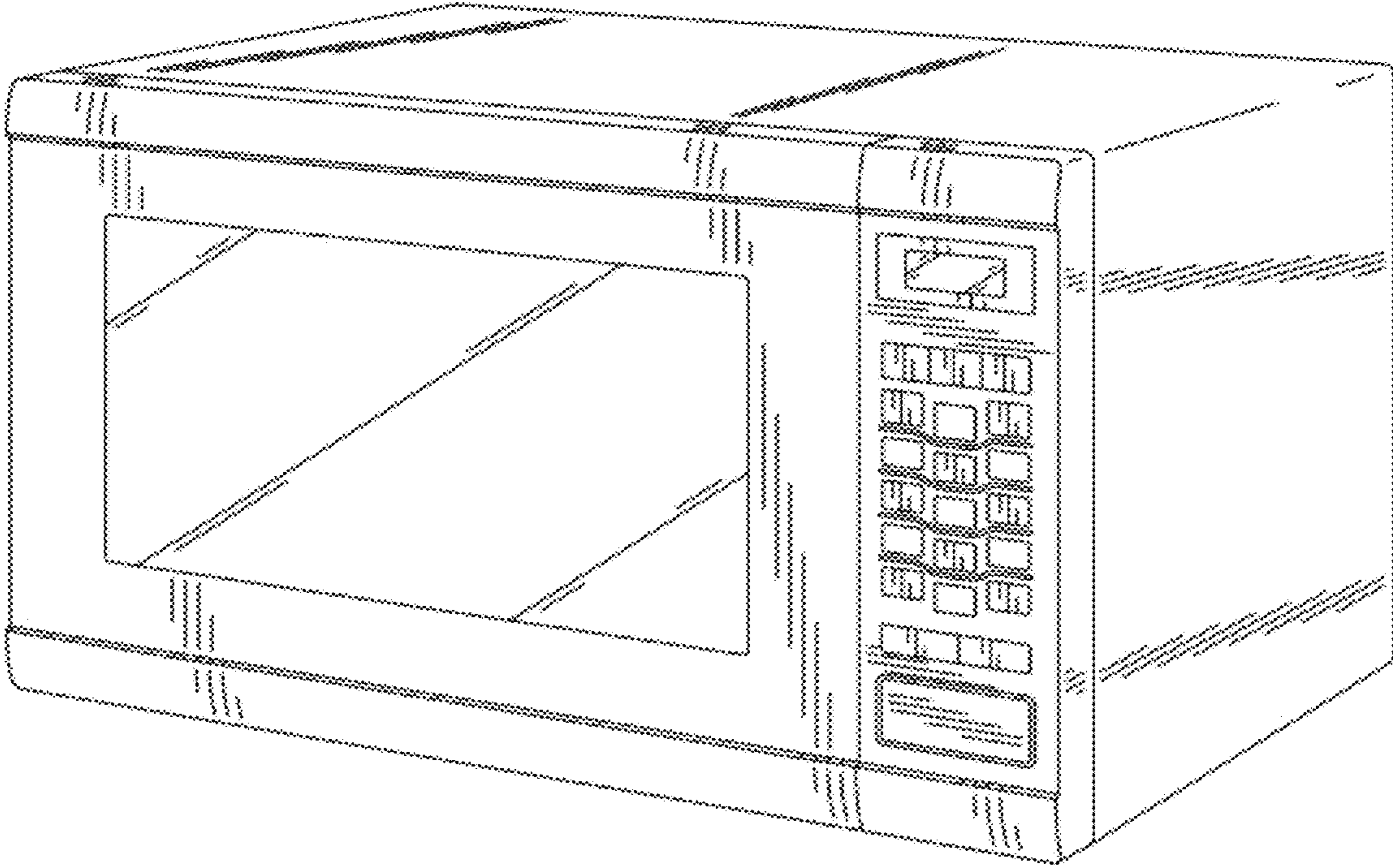

FIG.2

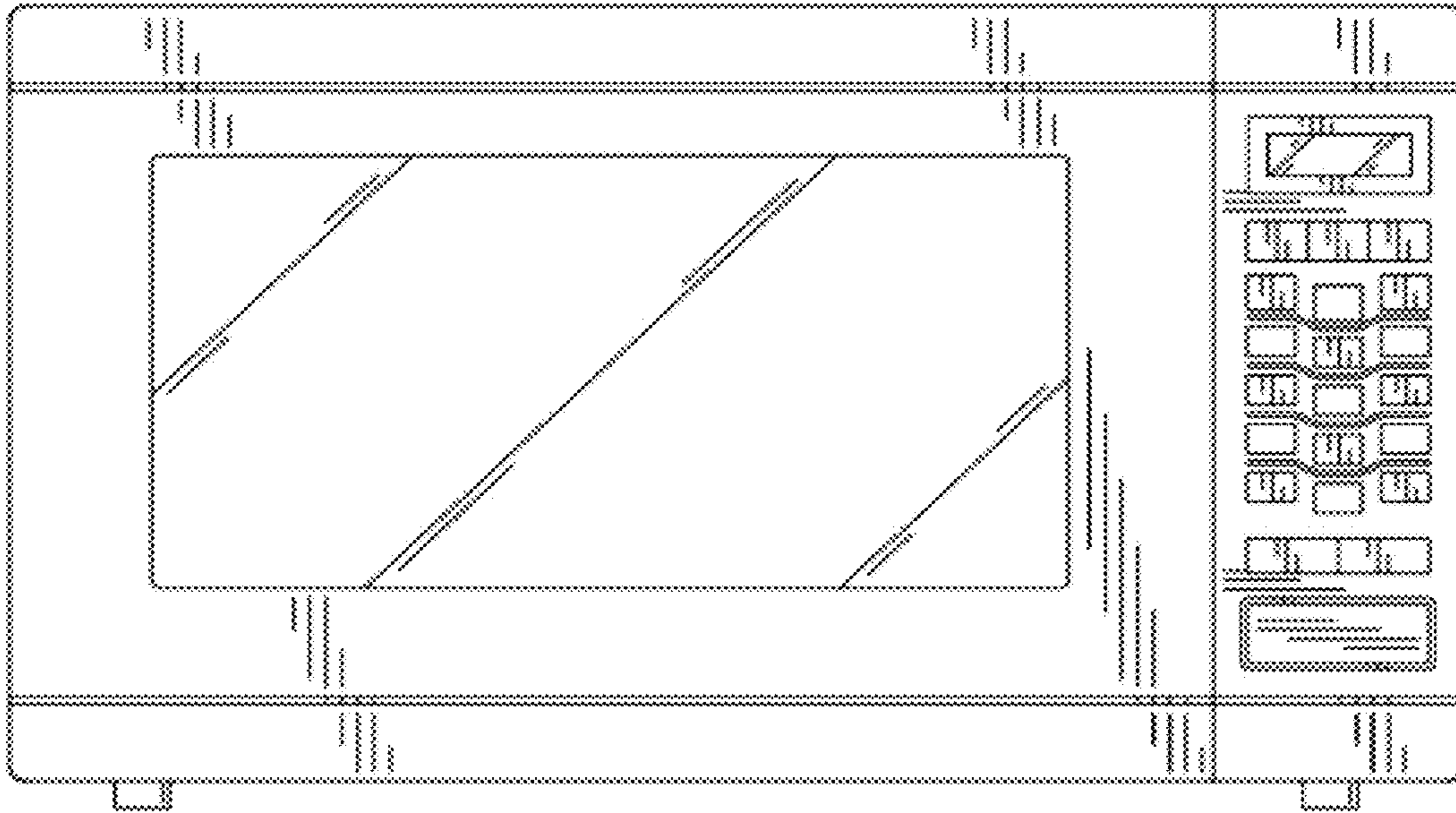

FIG.3

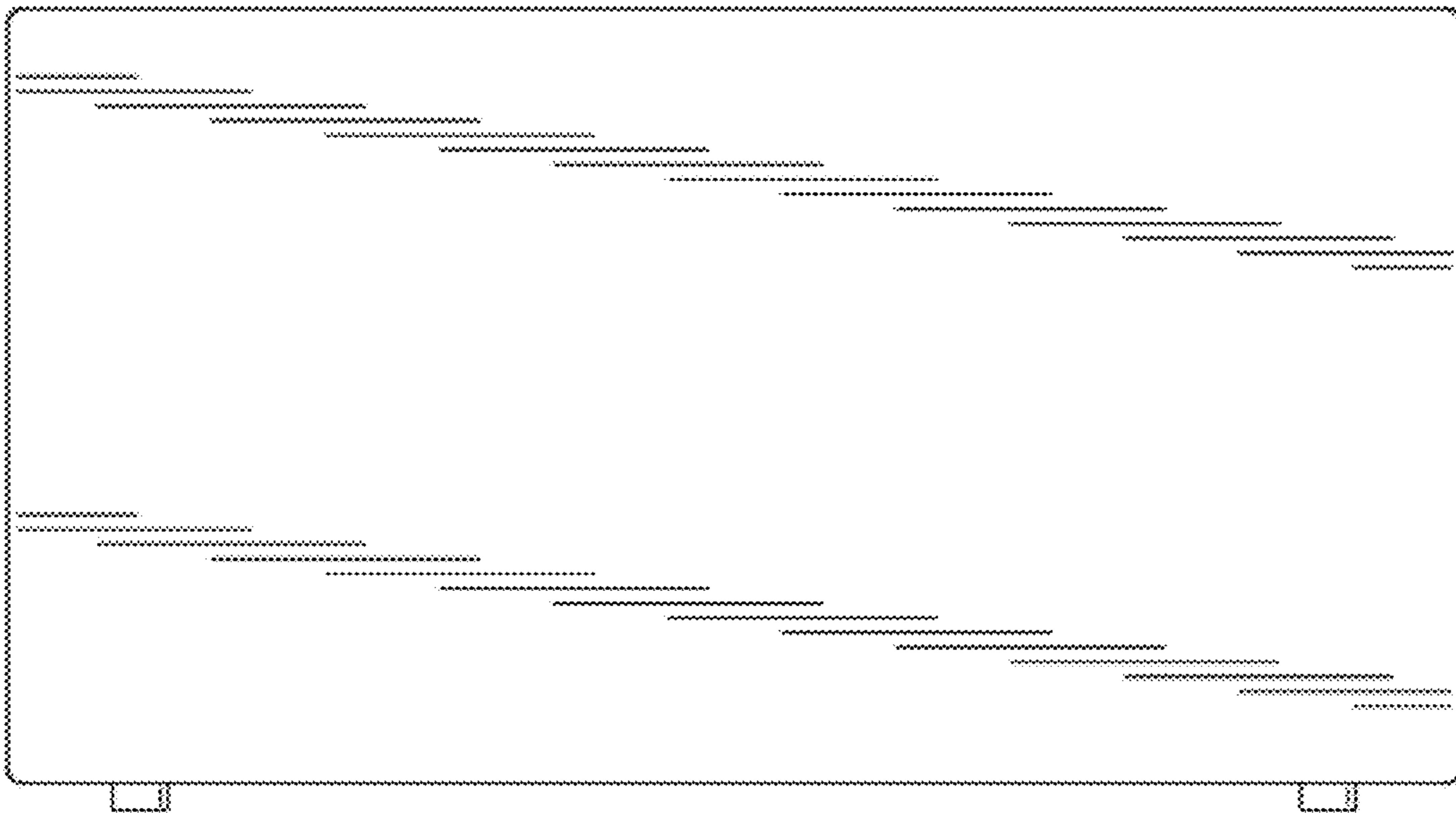

FIG.4

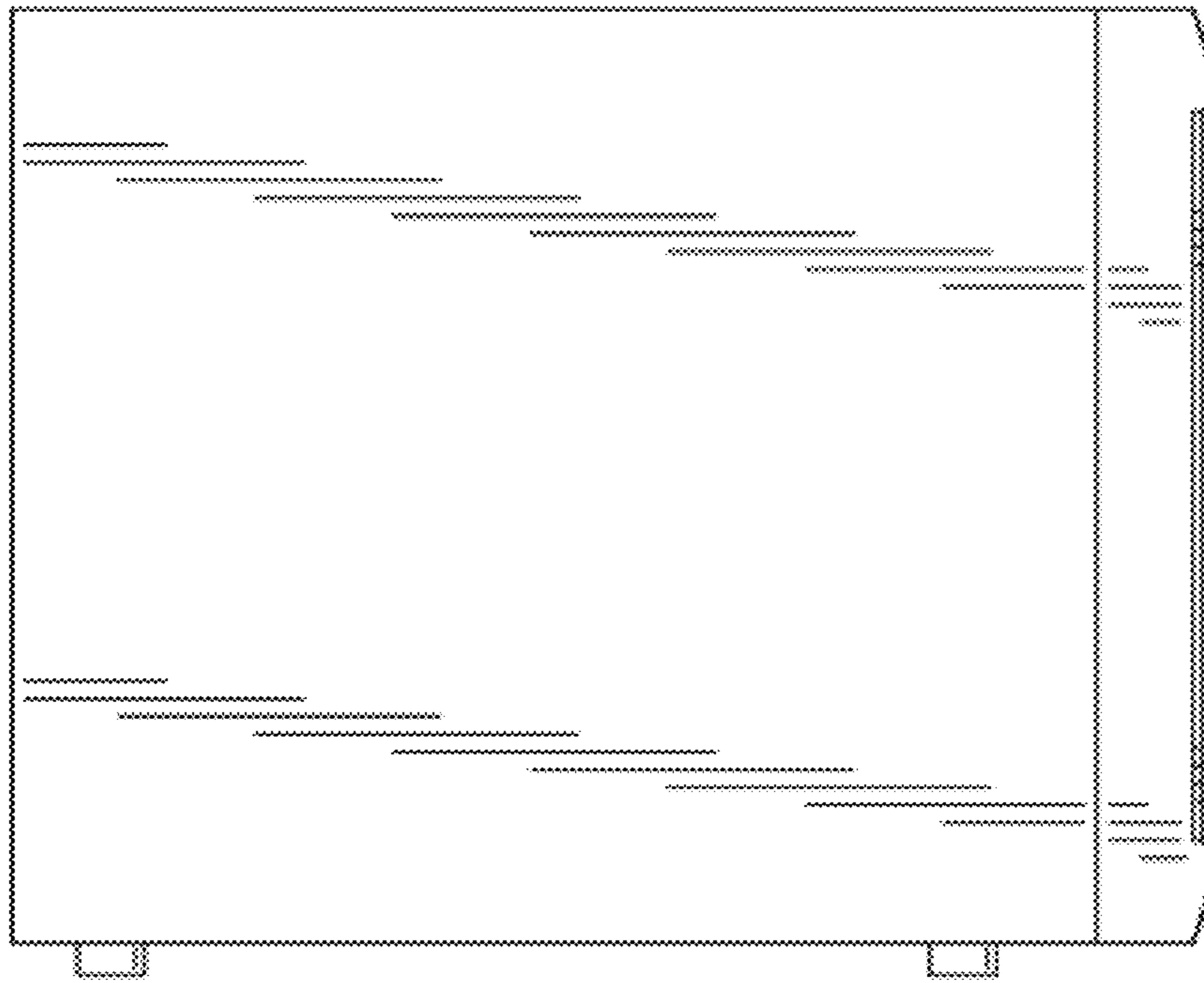

FIG.5

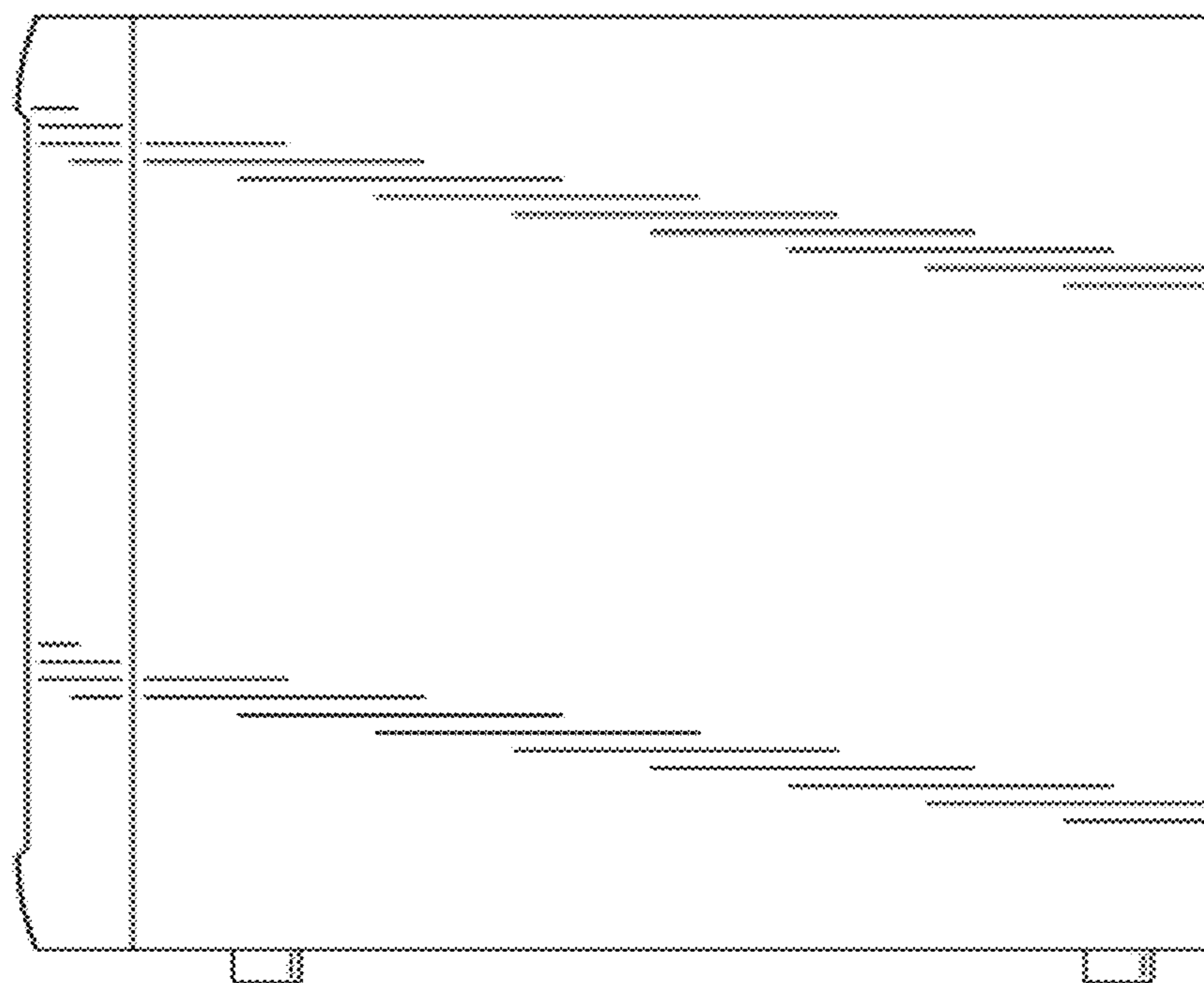

FIG. 6

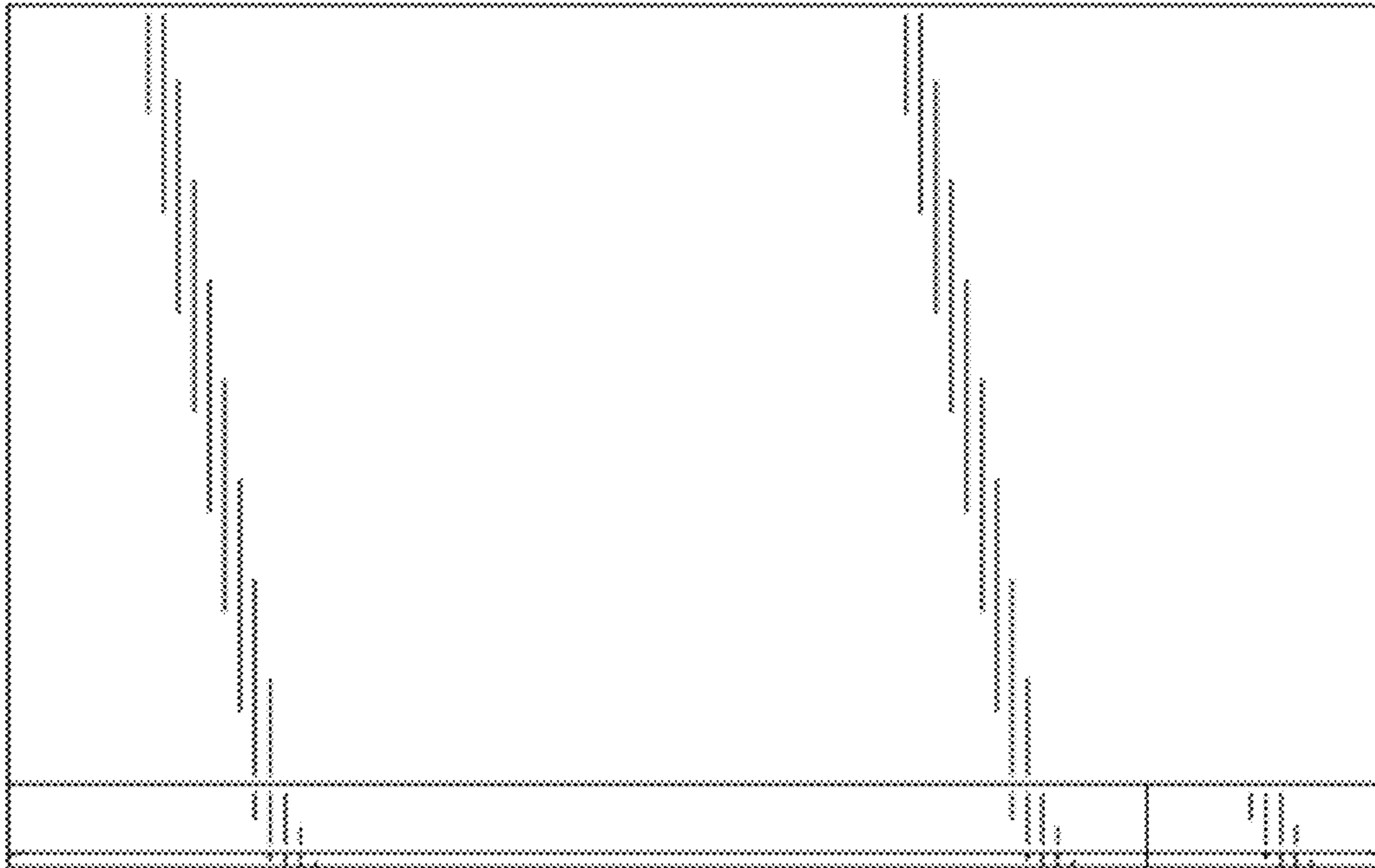

FIG. 7

