



US00D665127S

(12) **United States Design Patent**  
**Limongi**

(10) **Patent No.:** **US D665,127 S**

(45) **Date of Patent:** **\*\* Aug. 7, 2012**

(54) **APPLICATOR FOR COSMETICS**

(75) Inventor: **Michel Limongi**, Clichy (FR)

(73) Assignee: **Albéa Services**, Gennevilliers (FR)

(\*\*) Term: **14 Years**

(21) Appl. No.: **29/407,535**

(22) Filed: **Nov. 30, 2011**

(30) **Foreign Application Priority Data**

Jun. 1, 2011 (EM) ..... 001871989

(51) **LOC (9) Cl.** ..... **28-02**

(52) **U.S. Cl.** ..... **D28/7**

(58) **Field of Classification Search** ..... D28/7,  
D28/8, 20-22, 30-31, 76, 85, 99; 132/108,  
132/202, 208, 317.32, 321-329; 401/202-207,  
401/261-267; D9/723, 725-728; D24/119,  
D24/124, 133, 141, 152, 154, 211, 214, 215  
See application file for complete search history.

(56) **References Cited**

**U.S. PATENT DOCUMENTS**

2,103,261	A	12/1937	Hughes	
3,236,417	A	2/1966	Linton	
4,811,726	A *	3/1989	Goncalves et al.	601/154
5,131,384	A	7/1992	Obagi	
D341,445	S	11/1993	Morrison et al.	
D406,389	S *	3/1999	Henry	D28/7
D406,676	S	3/1999	Henry	

D426,916	S	6/2000	Ebert	
D428,142	S *	7/2000	Stromblad	D24/119
6,126,469	A	10/2000	Messer	
D450,153	S *	11/2001	Knieriemen	D28/7
6,925,672	B1	8/2005	Bromley	
D518,915	S	4/2006	Angeletta	
7,476,048	B2	1/2009	Prague	
D631,193	S	1/2011	Limongi et al.	

\* cited by examiner

*Primary Examiner* — Zenia Bennett

(74) *Attorney, Agent, or Firm* — Banner & Witcoff, Ltd.

(57) **CLAIM**

The ornamental design for an applicator for cosmetics, as shown and described.

**DESCRIPTION**

FIG. 1 is a top, front perspective view of an applicator for cosmetics showing my new design;  
 FIG. 2 is a front view thereof;  
 FIG. 3 is a right side view thereof;  
 FIG. 4 is a rear view thereof;  
 FIG. 5 is a left side view thereof;  
 FIG. 6 is a top view thereof;  
 FIG. 7 is a bottom view thereof;  
 FIG. 8 is a rear view of the applicator for cosmetics in which an upper portion of the applicator for cosmetics has been rotated 90 degrees; and,  
 FIG. 9 is a top perspective view thereof.  
 The broken lines showing the remainder of the applicator for cosmetics are for environmental purposes only and form no part of the claimed design.

**1 Claim, 8 Drawing Sheets**

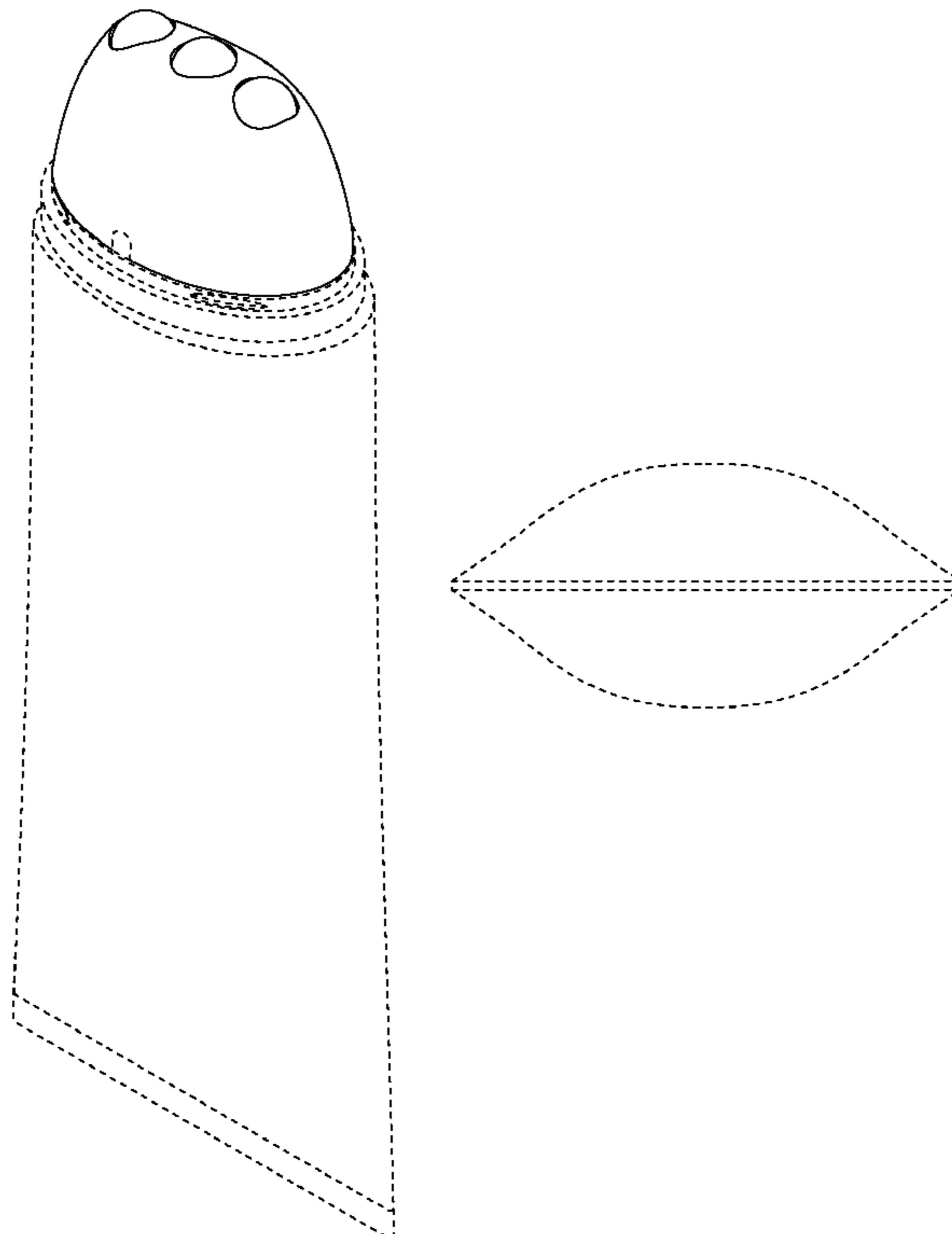

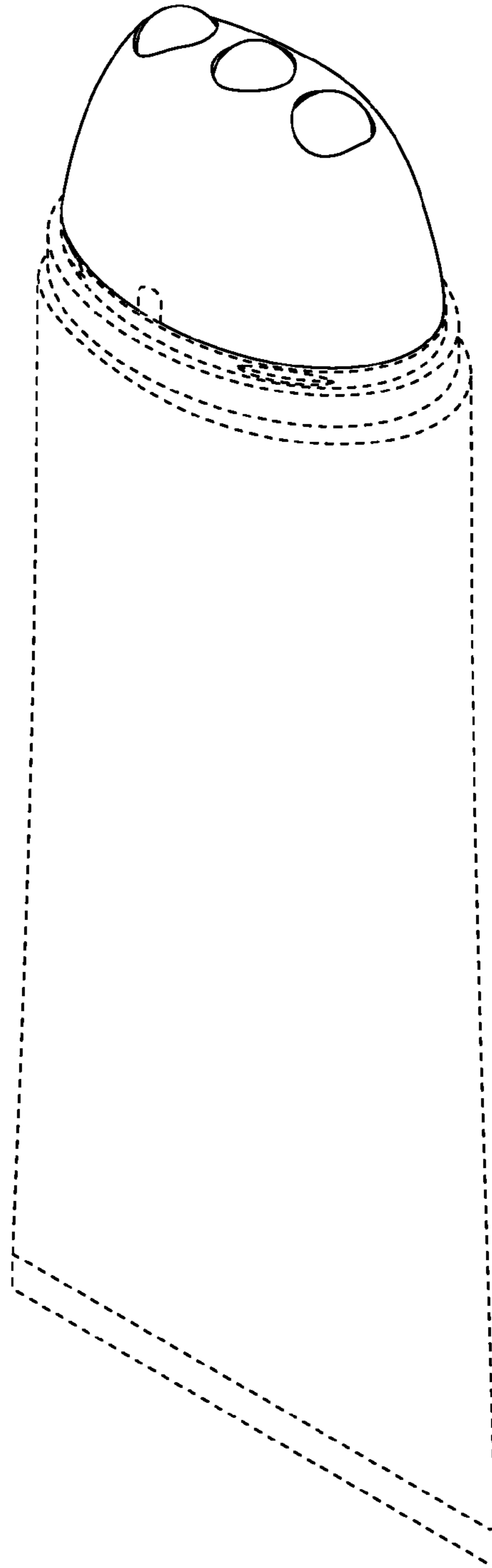

FIG. 1

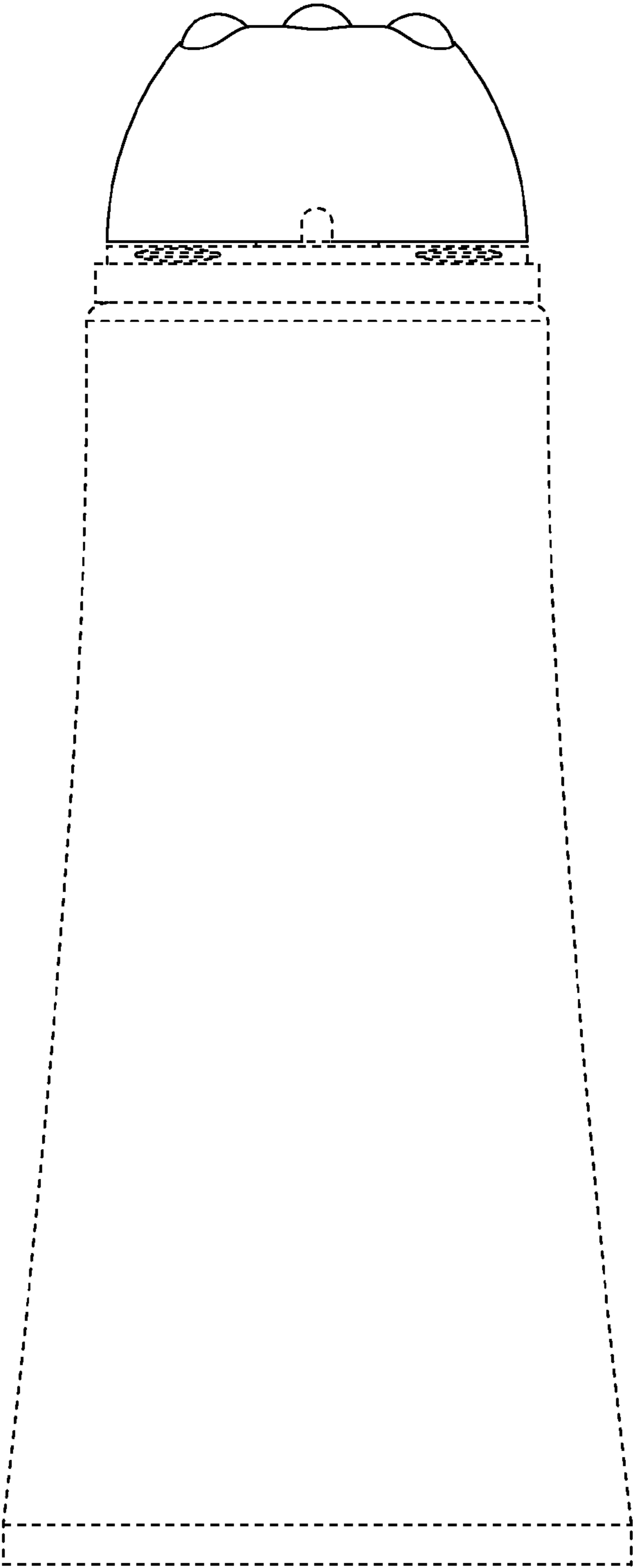

FIG. 2

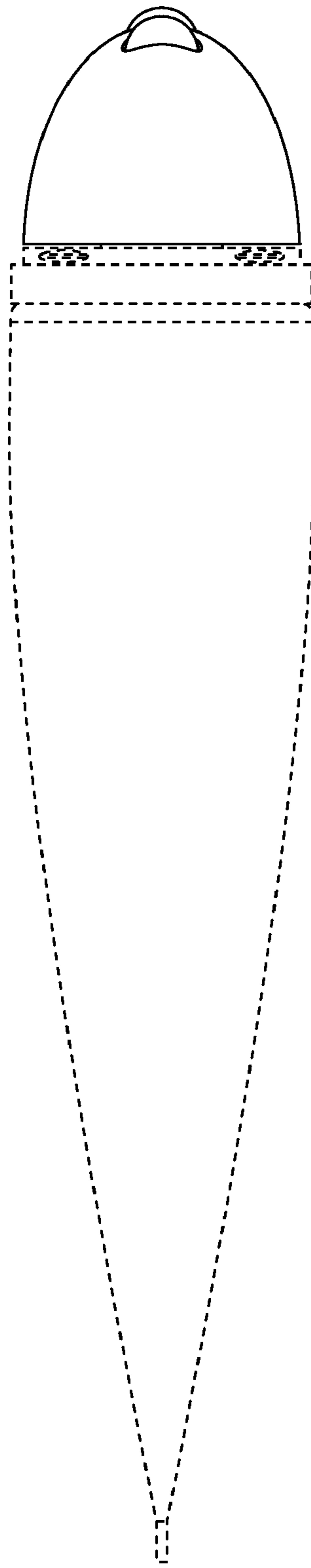

FIG. 3

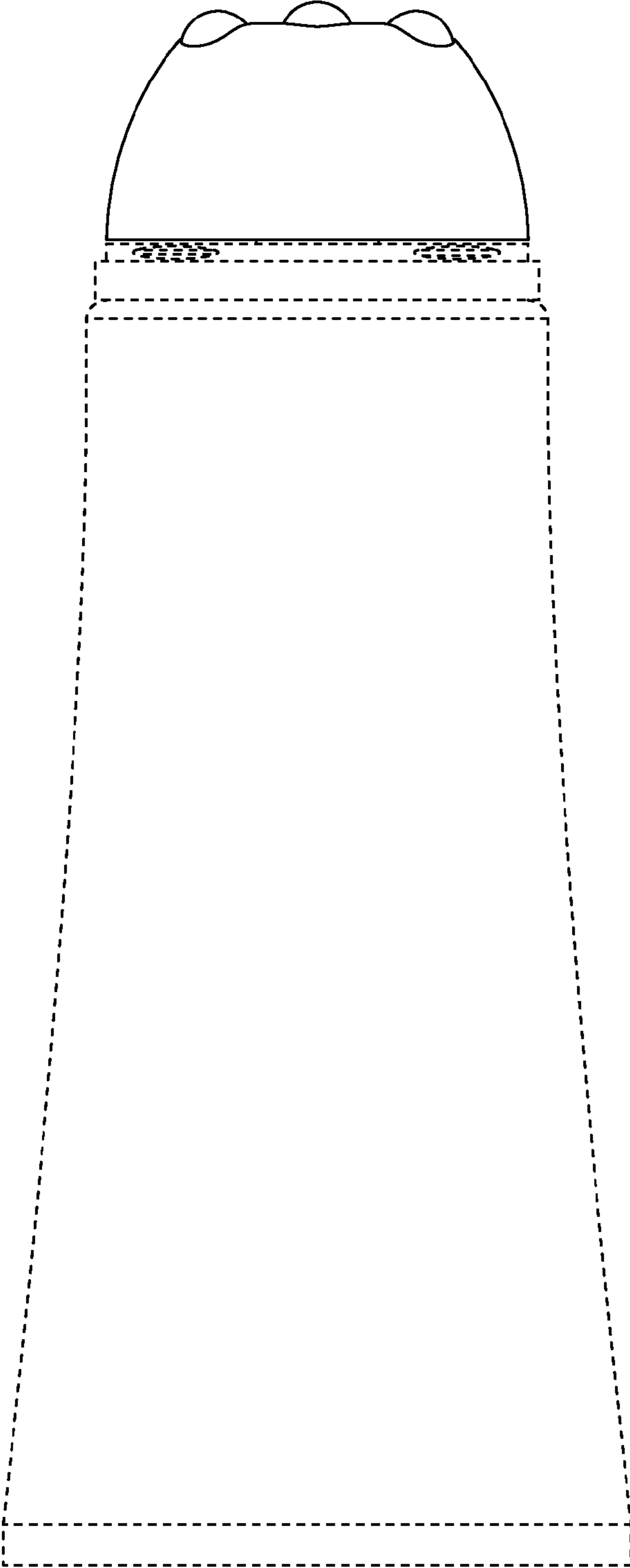

FIG. 4

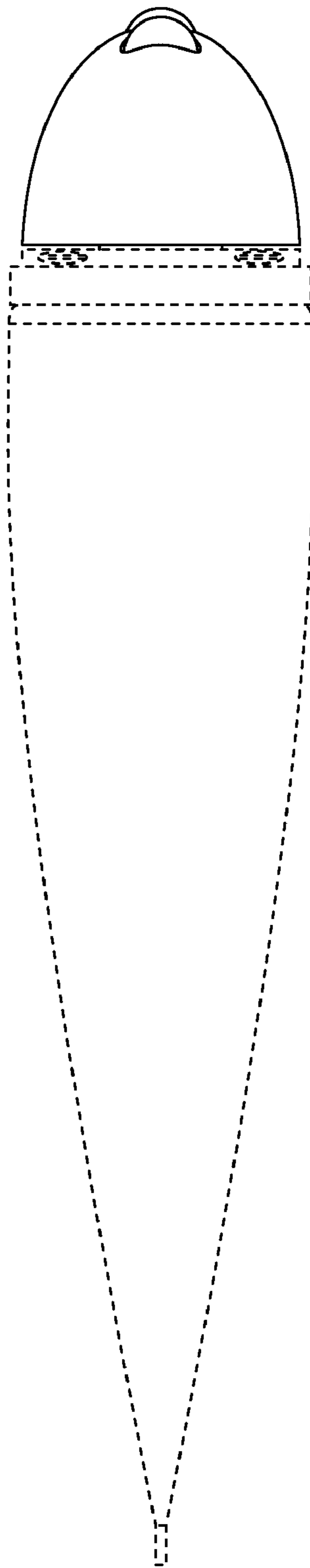

FIG. 5

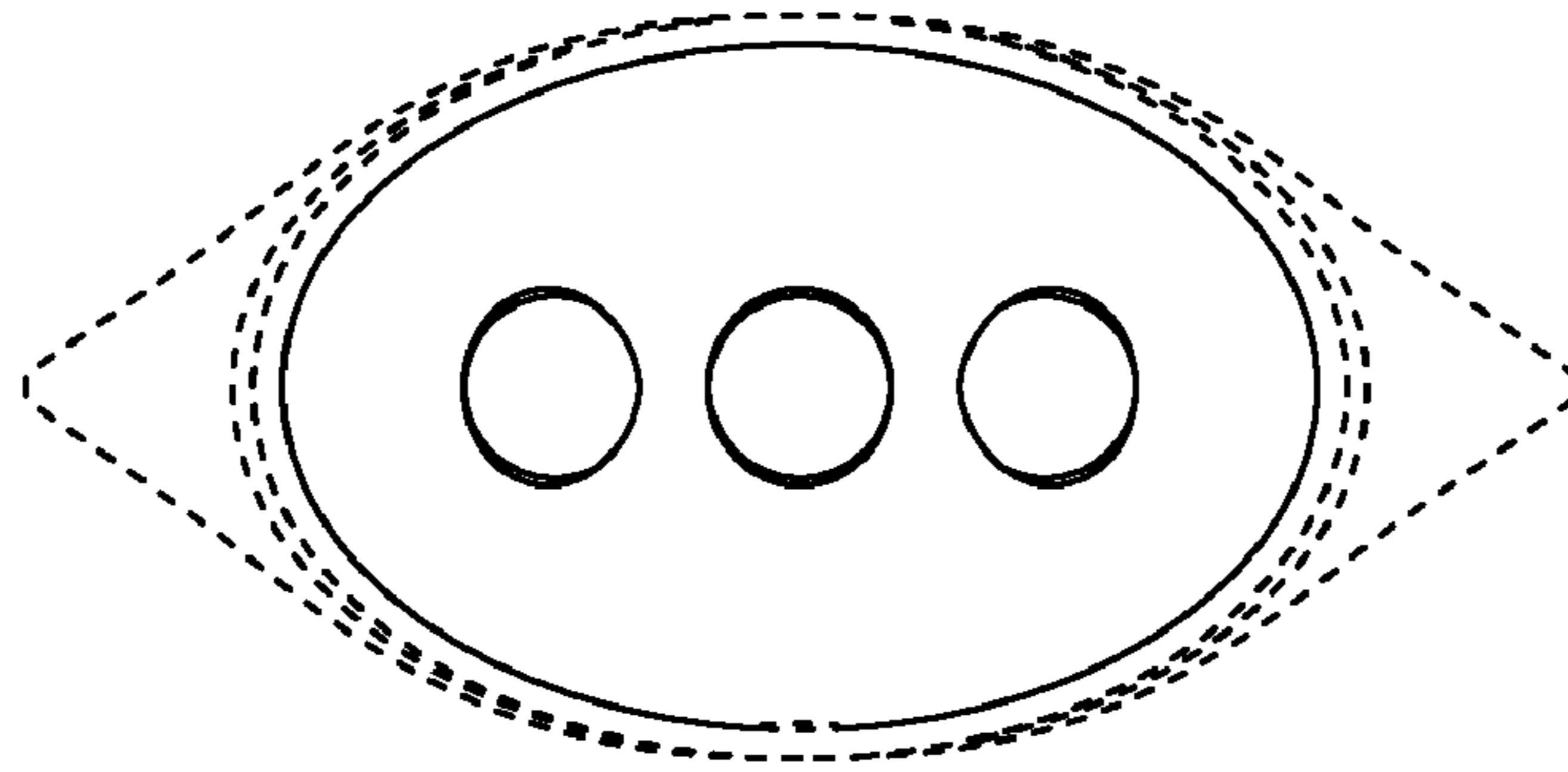

FIG. 6

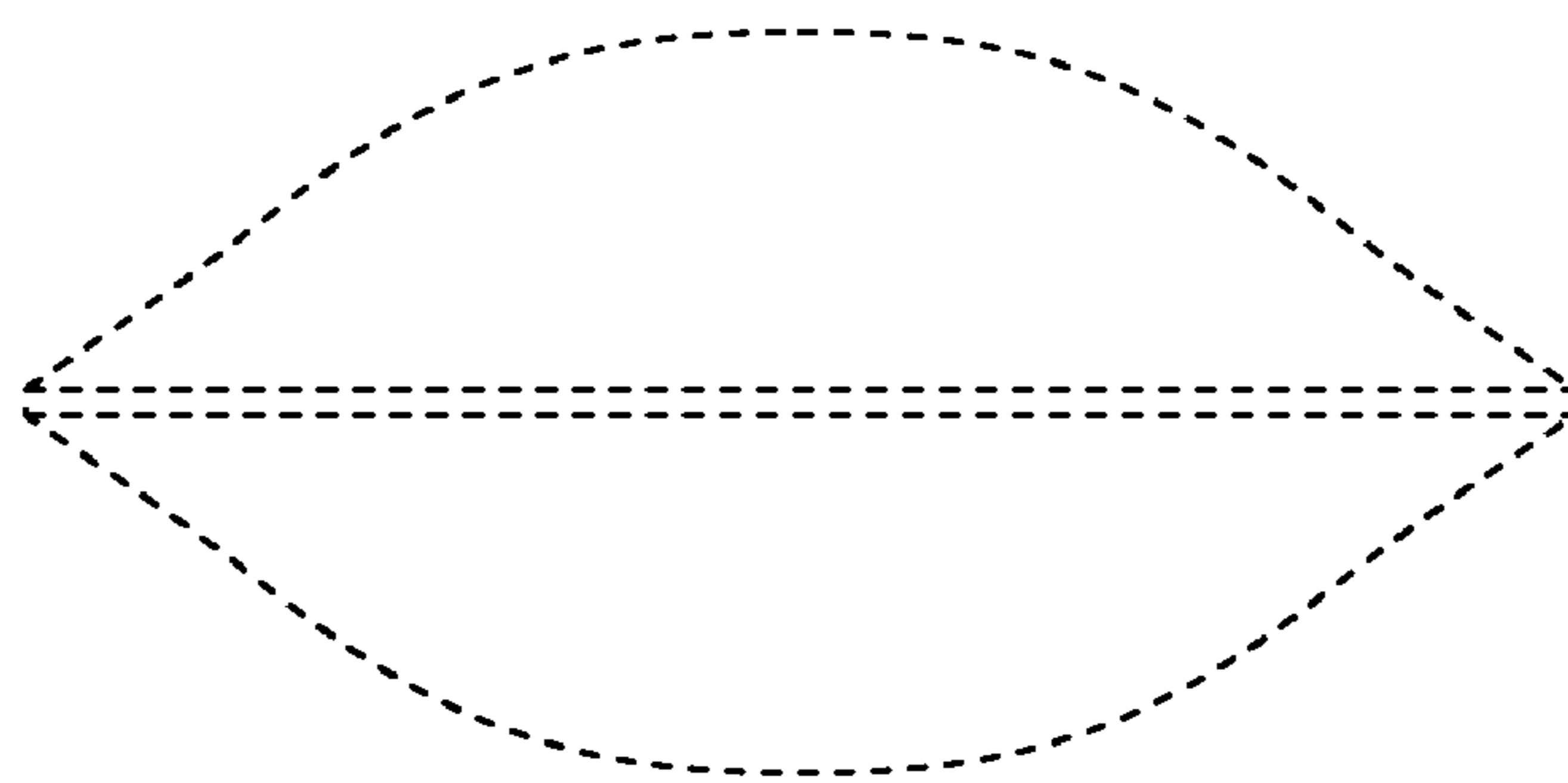

FIG. 7

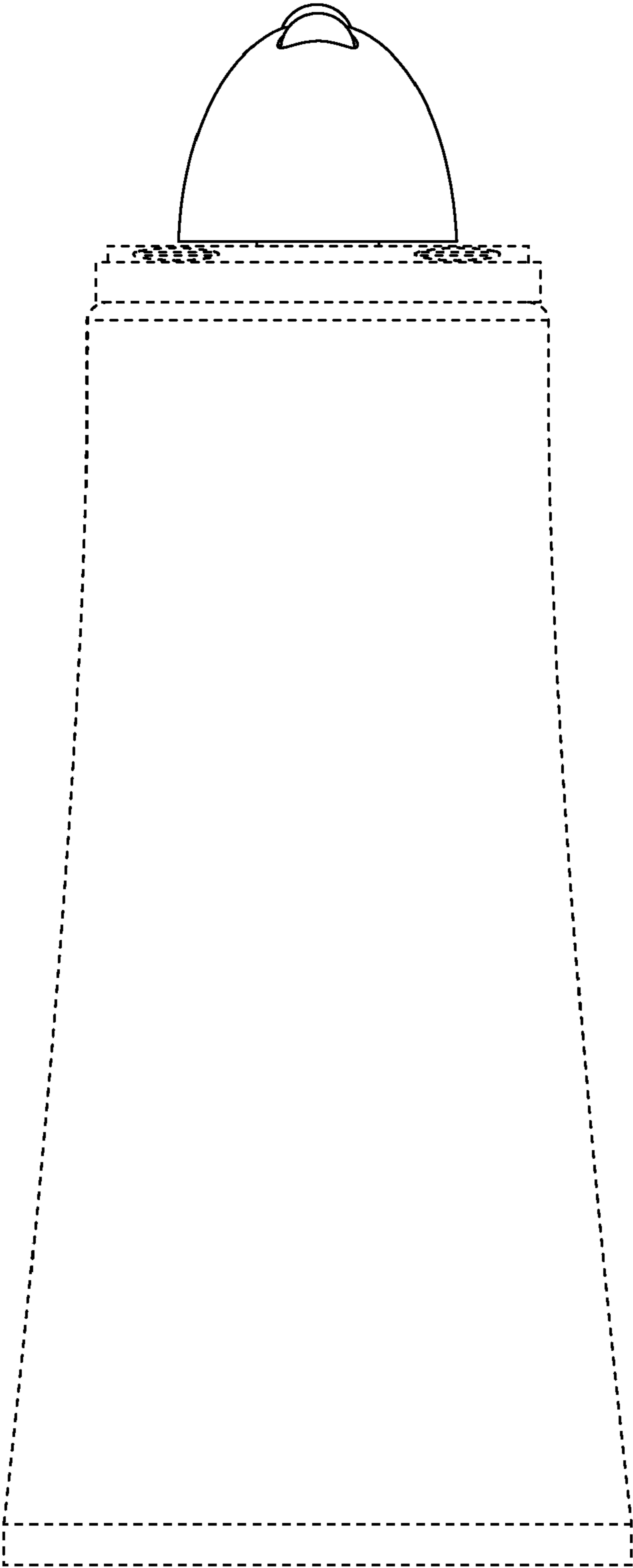

FIG. 8



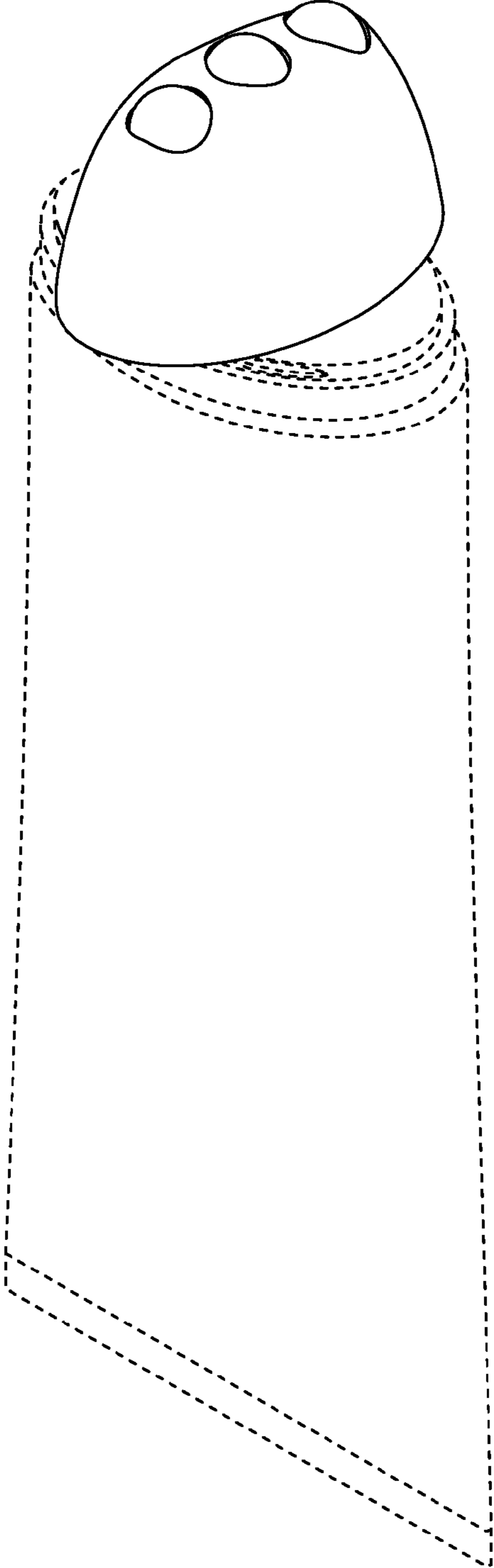

FIG. 9