

US00D664954S

(12) **United States Design Patent**
Kim et al.

(10) **Patent No.:** **US D664,954 S**

(45) **Date of Patent:** **** Aug. 7, 2012**

(54) **TABLET COMPUTER**

(75) Inventors: **Ik-Sang Kim**, Seoul (KR); **Sang-Won Yoon**, Seoul (KR)

(73) Assignee: **Samsung Electronics Co., Ltd.**, Suwon (KR)

(**) Term: **14 Years**

(21) Appl. No.: **29/390,462**

(22) Filed: **Apr. 25, 2011**

(30) **Foreign Application Priority Data**

Jan. 18, 2011 (KR) 30-2011-0002007

(51) **LOC (9) Cl.** **14-02**

(52) **U.S. Cl.** **D14/341**

(58) **Field of Classification Search** D14/341-347, D14/137, 138, 138.1, 138 A, 138 AA, 138 R, D14/138 AB, 138 AC, 138 AD, 138 C, 138 G, D14/496, 203.1, 203.3, 203.4, 203.5, 203.7, D14/426, 427, 432, 429, 129, 130, 420, 439-441, D14/448, 125, 126, 147, 156, 218, 247-248, D14/250, 389, 388, 315-318; D10/65, 104; D18/6-7; D21/324, 329, 330; D19/26, 59, D19/60; 455/556.1, 556.2, 566, 575.1, 90.3; 379/433.04, 433.01, 433.06, 916; 345/169, 345/173, 901, 905; 361/679.26, 679.27, 361/679.3, 679.55, 679.56

See application file for complete search history.

(56) **References Cited**

U.S. PATENT DOCUMENTS

D270,061 S * 8/1983 Ackeret D6/308
D284,084 S 6/1986 Ferrara, Jr.
D306,583 S 3/1990 Krolopp et al.
D333,574 S * 3/1993 Ackeret D6/300
D337,569 S 7/1993 Kando
D490,420 S * 5/2004 Solomon et al. D14/341
D500,991 S 1/2005 Niitsu
D504,889 S 5/2005 Andre et al.

D532,791 S * 11/2006 Kim D14/203.7
D558,460 S * 1/2008 Yu et al. D6/308
D563,804 S 3/2008 Kimura et al.
D579,930 S * 11/2008 Maskatia D14/341
D584,738 S 1/2009 Kim et al.
D590,374 S 4/2009 Madonna et al.
D592,214 S 5/2009 Bradford
D602,014 S 10/2009 Andre et al.
D602,487 S * 10/2009 Maskatia D14/341
D605,626 S 12/2009 Park
D610,582 S 2/2010 Sugitani et al.
D611,364 S 3/2010 Lenz et al.
D613,510 S 4/2010 Tzeng et al.

(Continued)

FOREIGN PATENT DOCUMENTS

KR 3005985190000 5/2011

(Continued)

OTHER PUBLICATIONS

U.S. Appl. No. 29/372,112, Applicant EunuaeShally Lee et al., filed Oct. 15, 2010, title Tablet Computer.

(Continued)

Primary Examiner — Barbara Fox

(74) *Attorney, Agent, or Firm* — Wood, Herron & Evans, LLP

(57) **CLAIM**

The ornamental design for a tablet computer, as shown and described.

DESCRIPTION

FIG. 1 is a top front perspective view of a tablet computer showing our new design;

FIG. 2 is a front elevational view thereof;

FIG. 3 is a rear elevational view thereof;

FIG. 4 is a left side elevational view thereof;

FIG. 5 is a right side elevational view thereof;

FIG. 6 is a top plan view thereof; and,

FIG. 7 is a bottom plan view thereof.

1 Claim, 5 Drawing Sheets

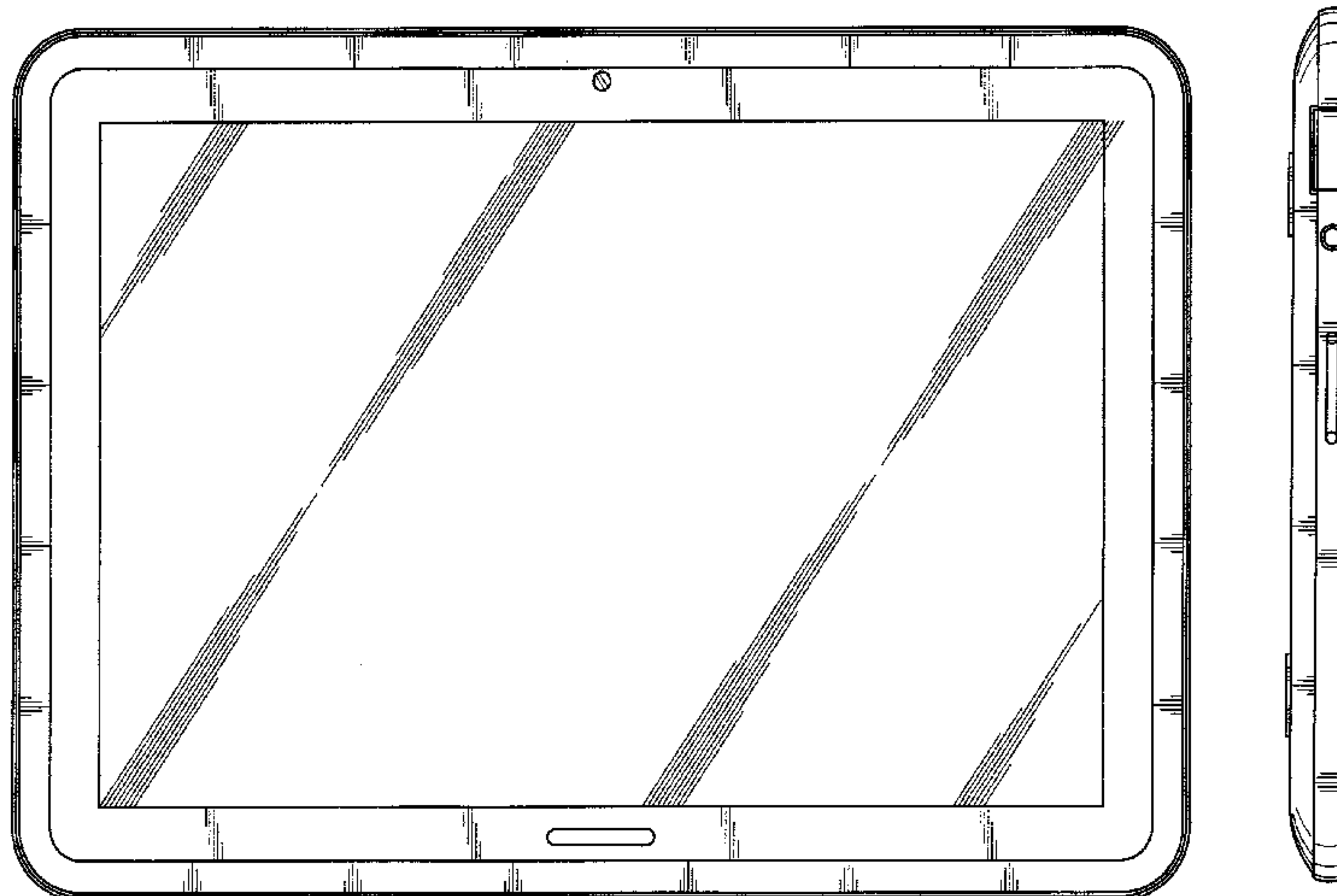

US D664,954 S

Page 2

U.S. PATENT DOCUMENTS

D613,951 S 4/2010 Tang et al.
D617,793 S * 6/2010 Chiang et al. D14/341
D622,270 S 8/2010 Andre et al.
D625,306 S * 10/2010 Miyawaki D14/341
D627,667 S 11/2010 Lenz et al.
D628,913 S 12/2010 Cheng
D629,799 S 12/2010 Andre et al.
D636,391 S * 4/2011 Shen et al. D14/341
D636,769 S * 4/2011 Wood et al. D14/341
D638,412 S * 5/2011 Lee D14/250
D639,805 S * 6/2011 Song et al. D14/341
D640,220 S * 6/2011 Shyu et al. D14/138 G
D640,255 S 6/2011 Lee et al.
D641,018 S * 7/2011 Lee et al. D14/341
D646,902 S * 10/2011 Woo et al. D6/308

D650,381 S * 12/2011 Park et al. D14/341
D654,893 S * 2/2012 Jung D14/138 G
2009/0231292 A1 9/2009 Hsieh et al.

FOREIGN PATENT DOCUMENTS

KR 3005994750000 5/2011
KR 3006004150000 6/2011
KR 3006004300000 6/2011
KR 3006046440000 7/2011

OTHER PUBLICATIONS

U.S. Appl. No. 29/390,464, Applicant: Kim, et al., filed Apr. 25, 2011
entitled Tablet Computer.
U.S. Appl. No. 29/390,462, Applicant: Kim, et al., filed Apr. 25, 2011
entitled Tablet Computer.

* cited by examiner

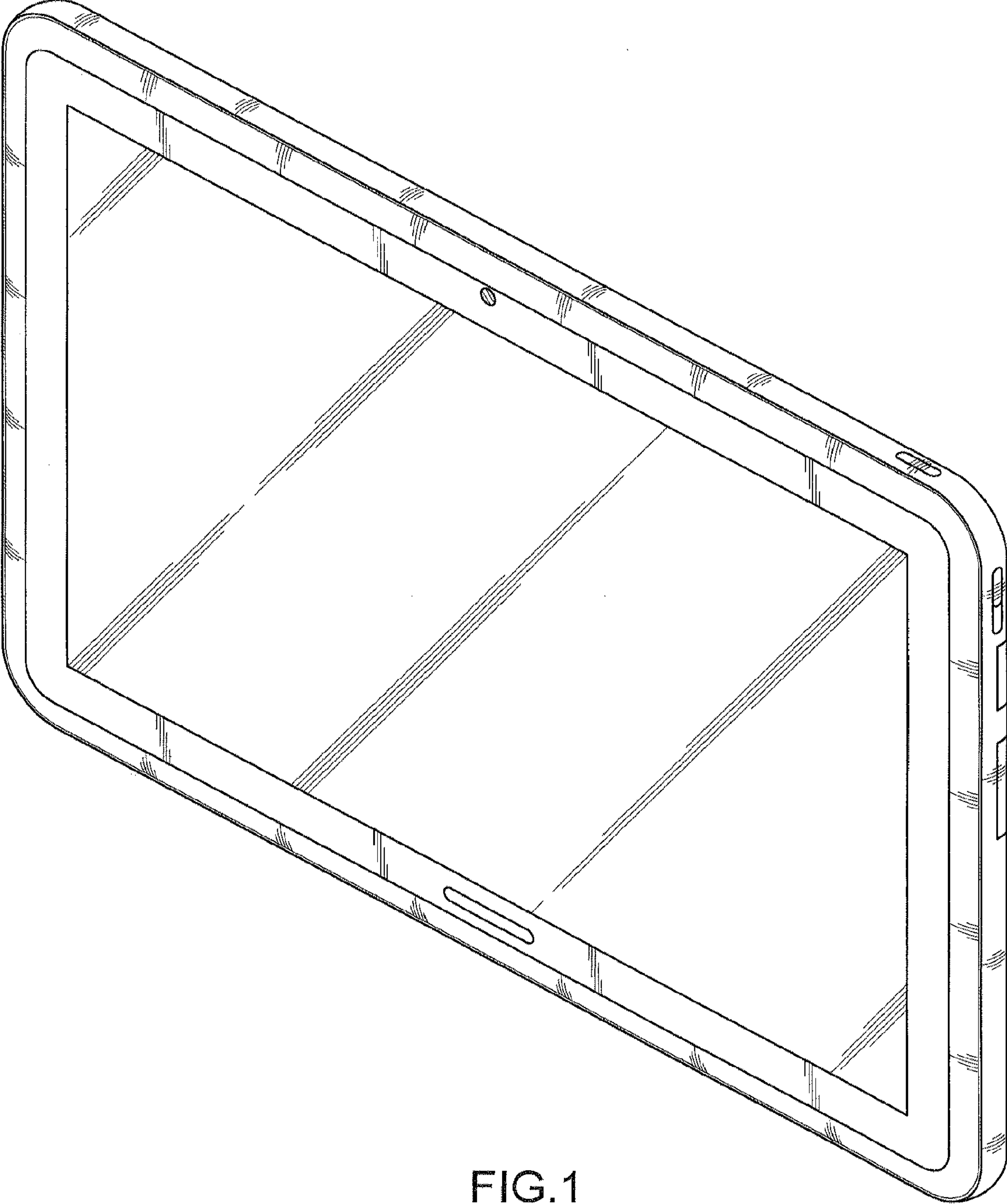

FIG.1

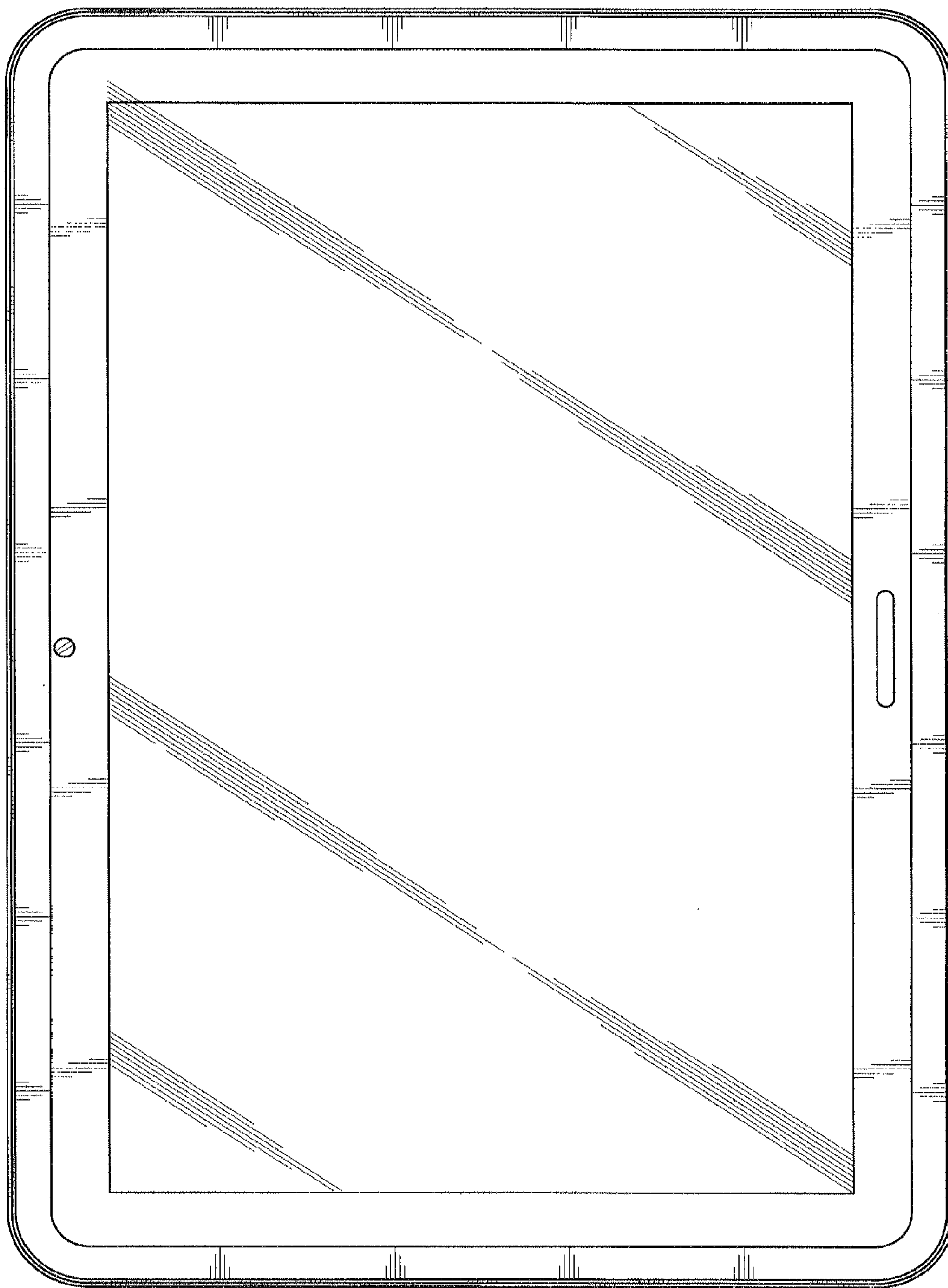

FIG.2

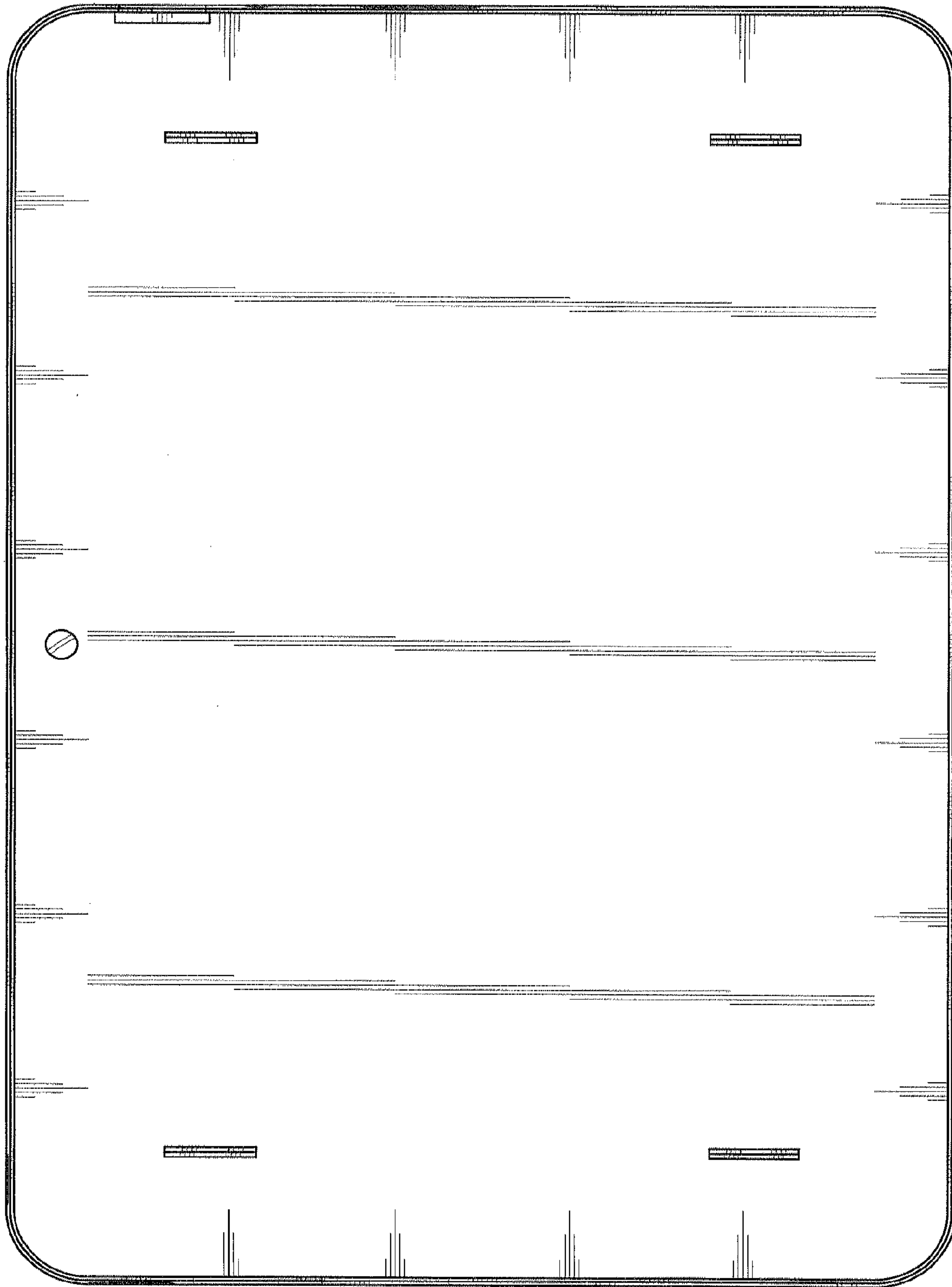

FIG.3

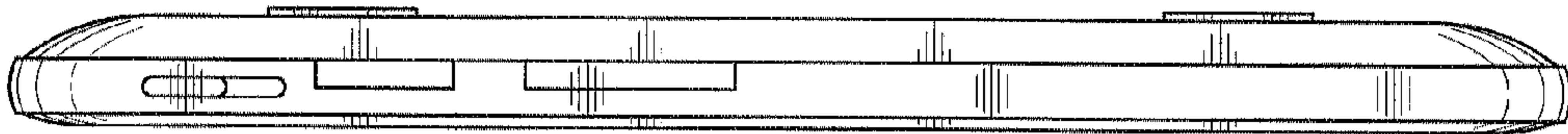

FIG.5

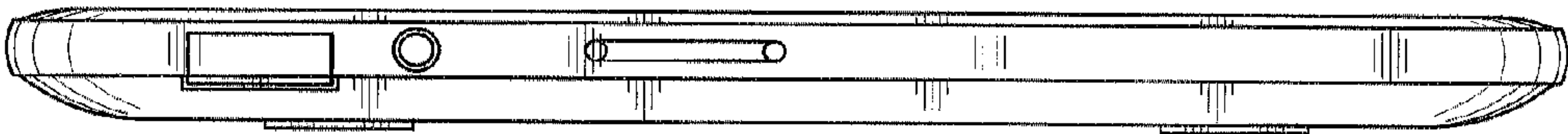

FIG.4

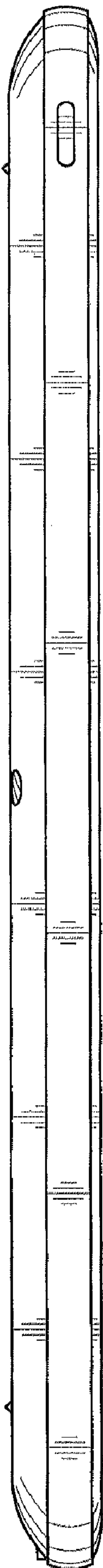

FIG. 6



FIG. 7