



US00D664953S

(12) **United States Design Patent**
Hung et al.

(10) **Patent No.:** **US D664,953 S**

(45) **Date of Patent:** **** Aug. 7, 2012**

(54) **HINGE FOR PORTABLE ELECTRONIC DEVICE**

(75) Inventors: **Li-Wei Hung**, Taipei (TW); **Ling-Wei Hou**, Taipei (TW)

(73) Assignee: **ASUSTeK Computer Inc.**, Taipei (TW)

(**) Term: **14 Years**

(21) Appl. No.: **29/399,882**

(22) Filed: **Aug. 19, 2011**

(51) **LOC (9) Cl.** **14-02**

(52) **U.S. Cl.** **D14/327**

(58) **Field of Classification Search** D14/315-327,
D14/349, 356; D18/1, 2, 7, 11; 235/145 A,
235/145 R; 341/22, 23; 345/104, 156, 168,
345/169, 173; 361/679.08, 679.09, 679.11,
361/679.26, 679.27

See application file for complete search history.

(56) **References Cited**

U.S. PATENT DOCUMENTS

D391,987 S * 3/1998 Jambhekar et al. D14/345
7,463,481 B2 * 12/2008 Lev et al. 361/679.27
D615,538 S * 5/2010 Huang et al. D14/315
D628,569 S * 12/2010 Guo D14/341

D630,221 S * 1/2011 Sogabe et al. D14/439
2004/0212602 A1 * 10/2004 Nako et al. 345/173
2011/0085829 A1 * 4/2011 Kitagawa 399/313

* cited by examiner

Primary Examiner — Freda S Nunn

(74) *Attorney, Agent, or Firm* — Muncy, Geissler, Olds & Lowe, PLLC

(57) **CLAIM**

The ornamental design for a hinge for a portable electronic device, as shown and described.

DESCRIPTION

FIG. 1 is a perspective view of a hinge for portable electronic device showing our new design;

FIG. 2 is a front elevational view thereof;

FIG. 3 is a rear elevational view thereof;

FIG. 4 is a left side elevational view thereof;

FIG. 5 is a right side elevational view thereof;

FIG. 6 is a top plan view thereof;

FIG. 7 front perspective view thereof in an open position;

FIG. 8 is a rear perspective view thereof; and,

FIG. 9 is a right side elevational view thereof.

The broken lines shown in the figures immediately adjacent to the solid lines represent the bounds of the claimed design, while all other lines are directed to environment and form no part of the claimed design.

1 Claim, 8 Drawing Sheets

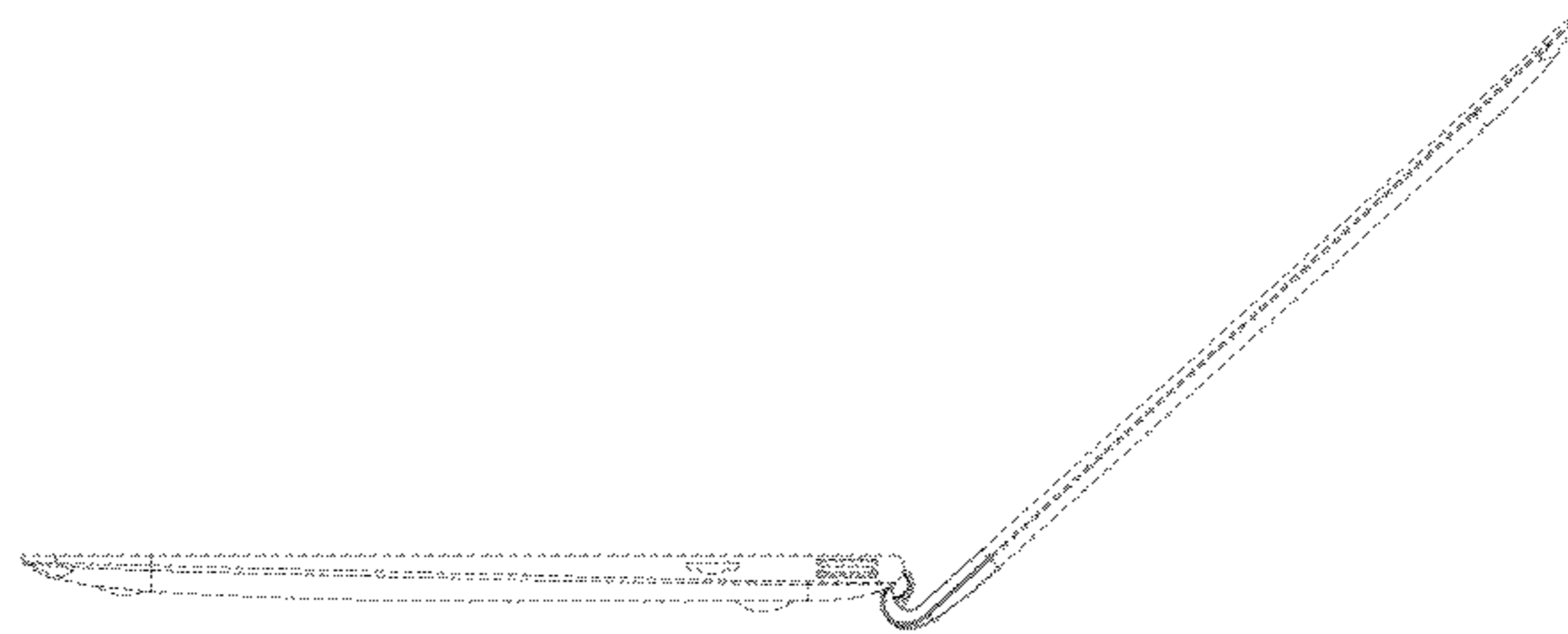
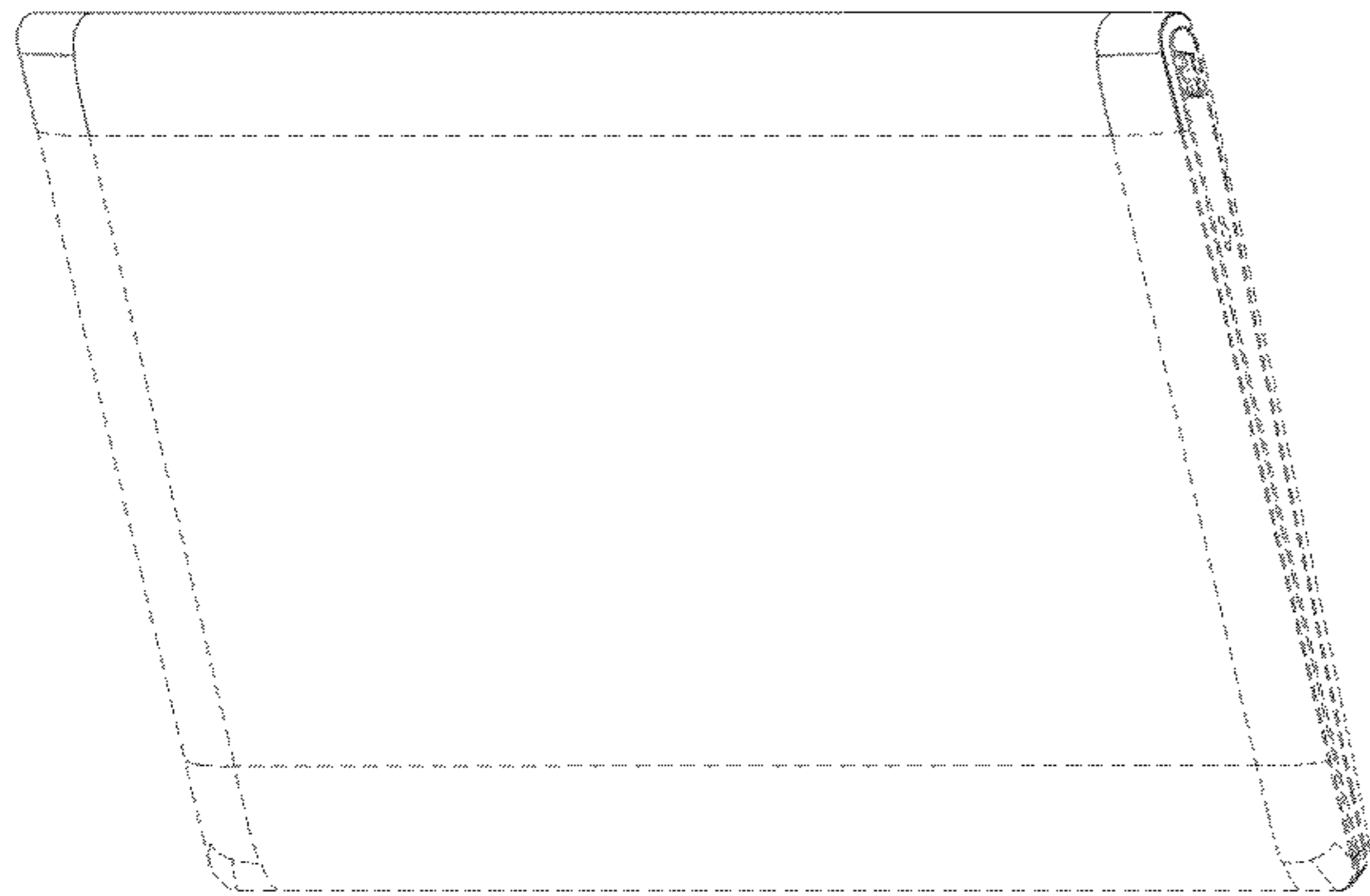

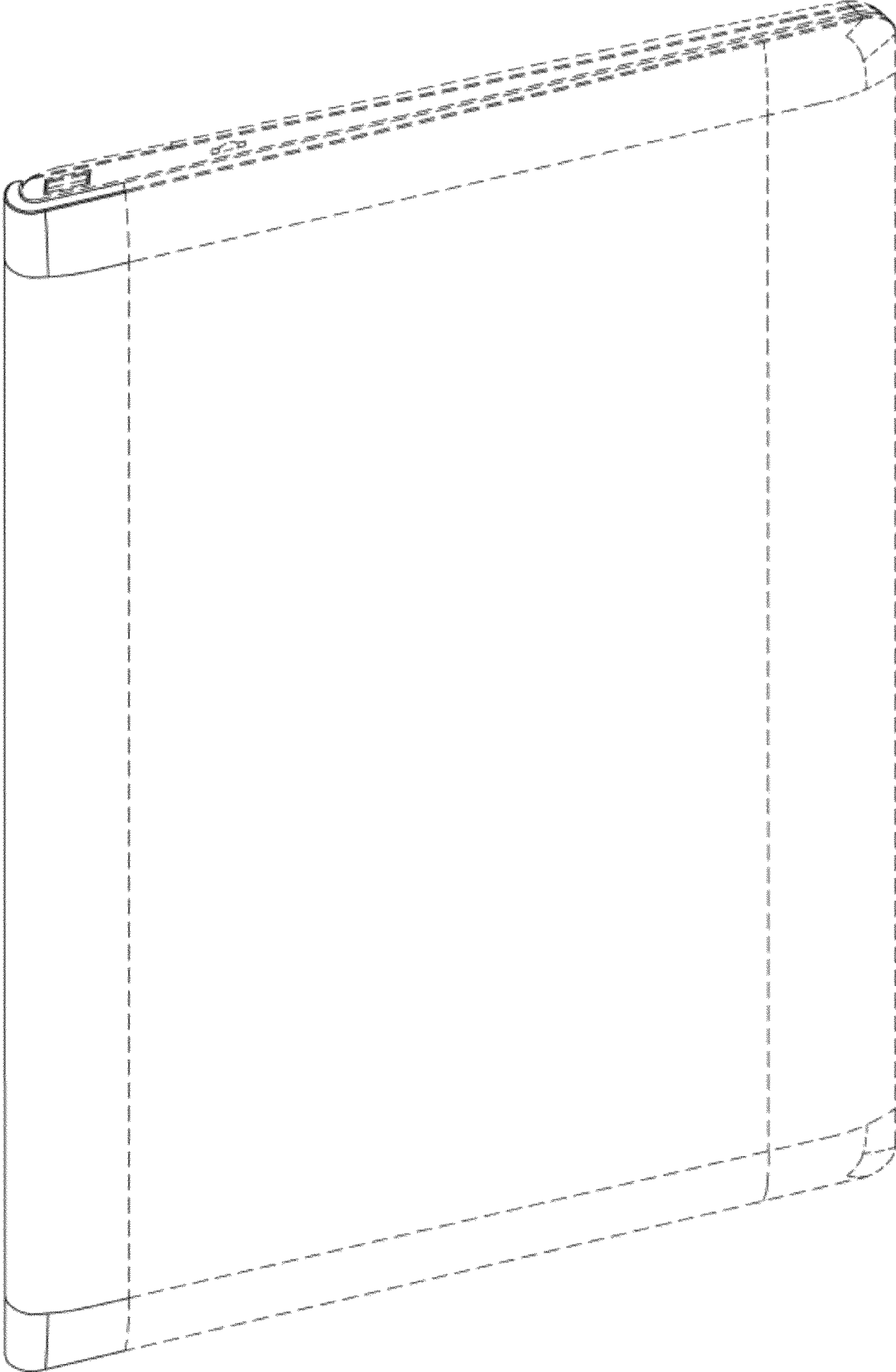

FIG. 1

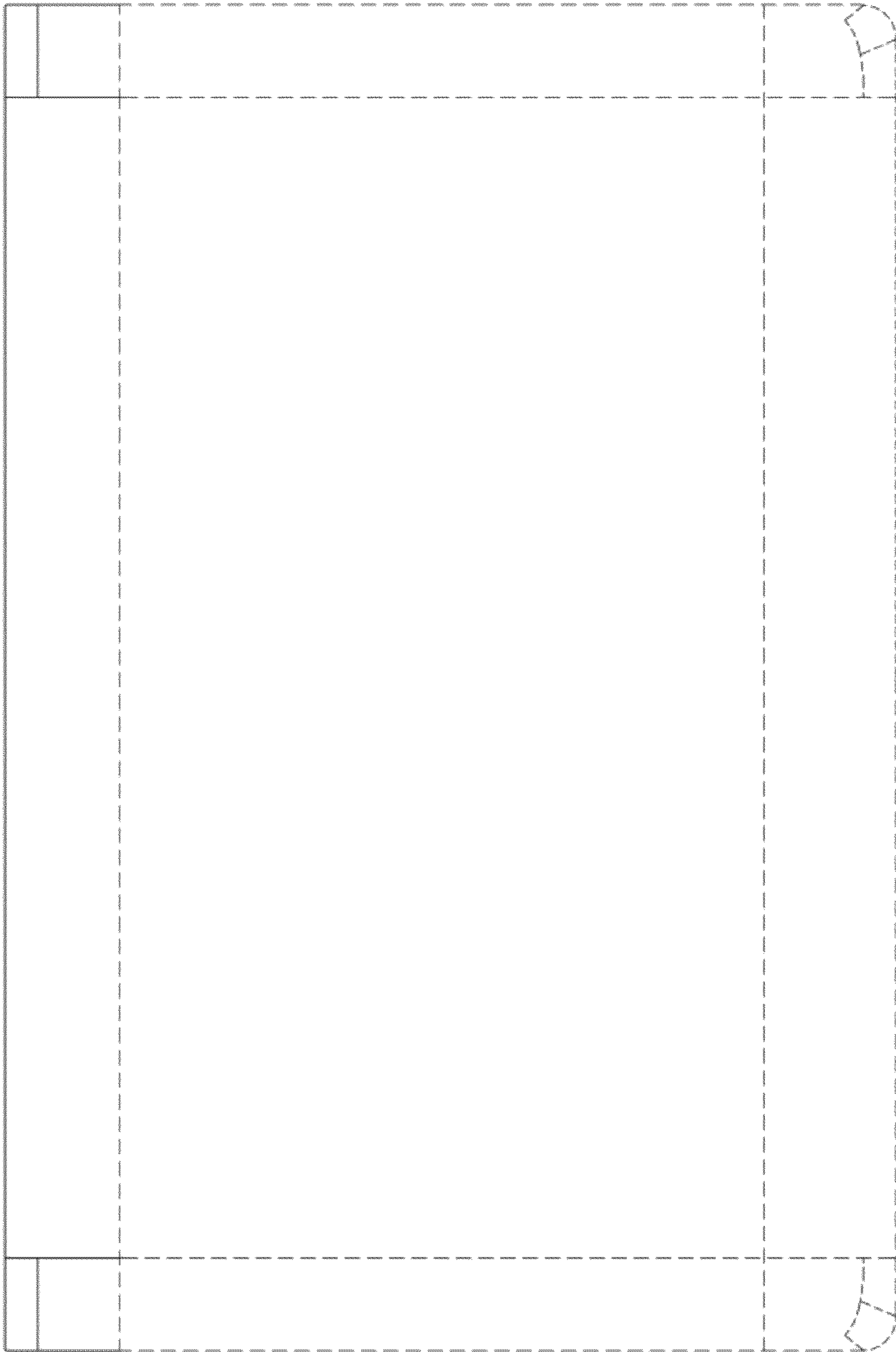

FIG. 2

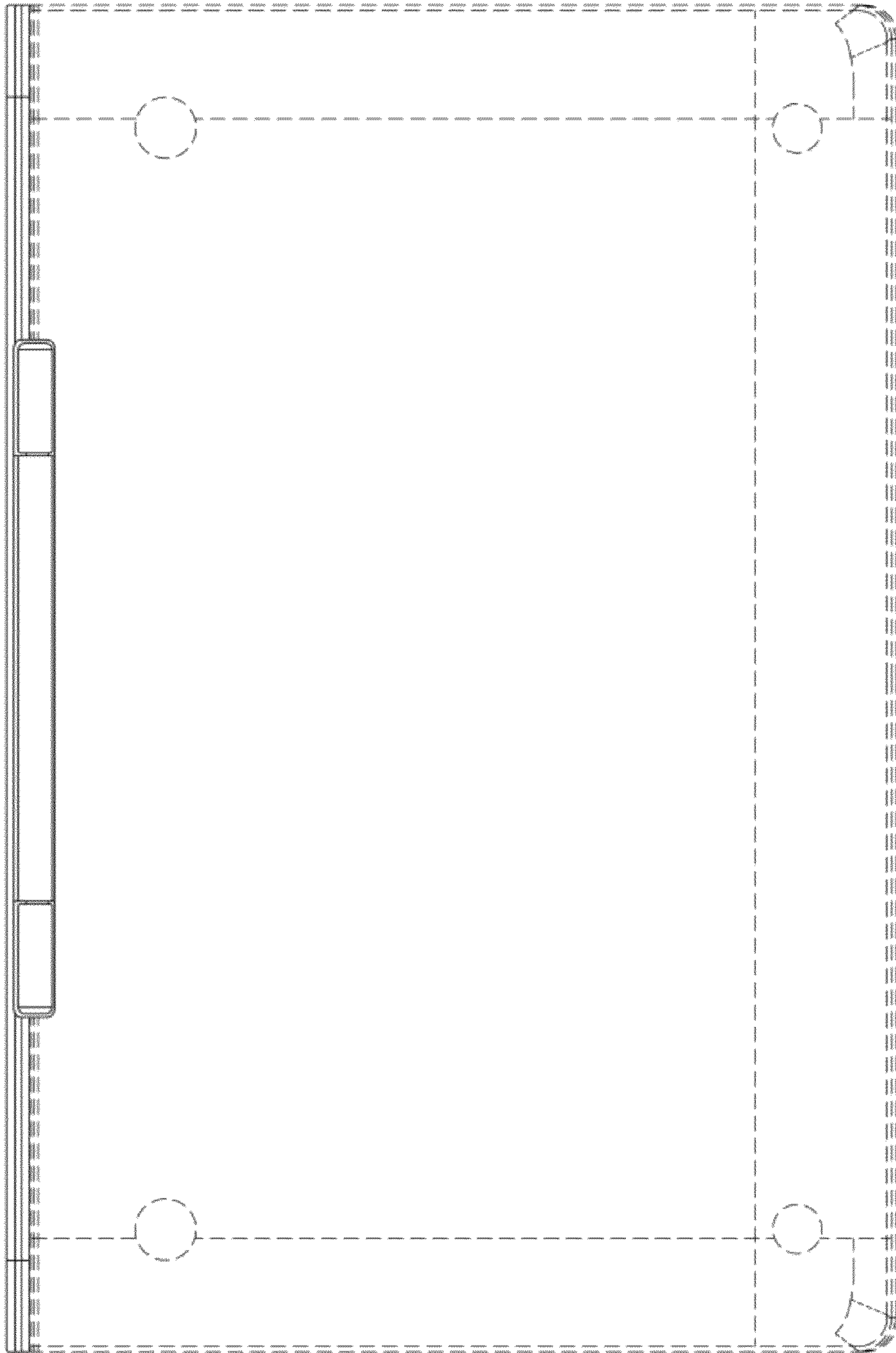

FIG. 3

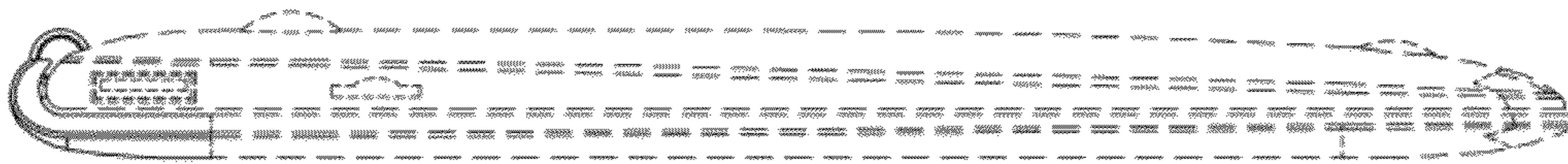

FIG. 5

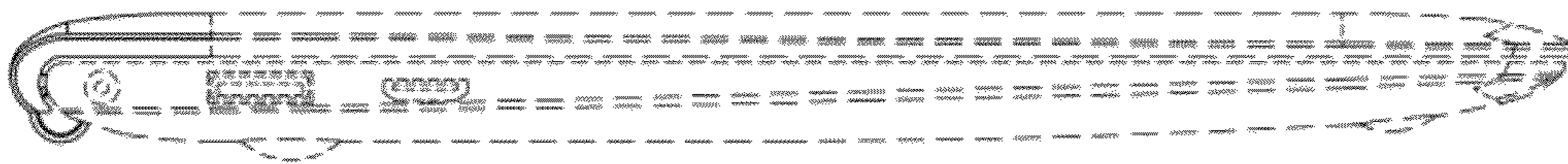

FIG. 4

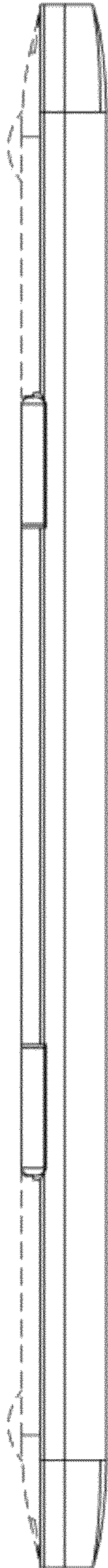

FIG. 6

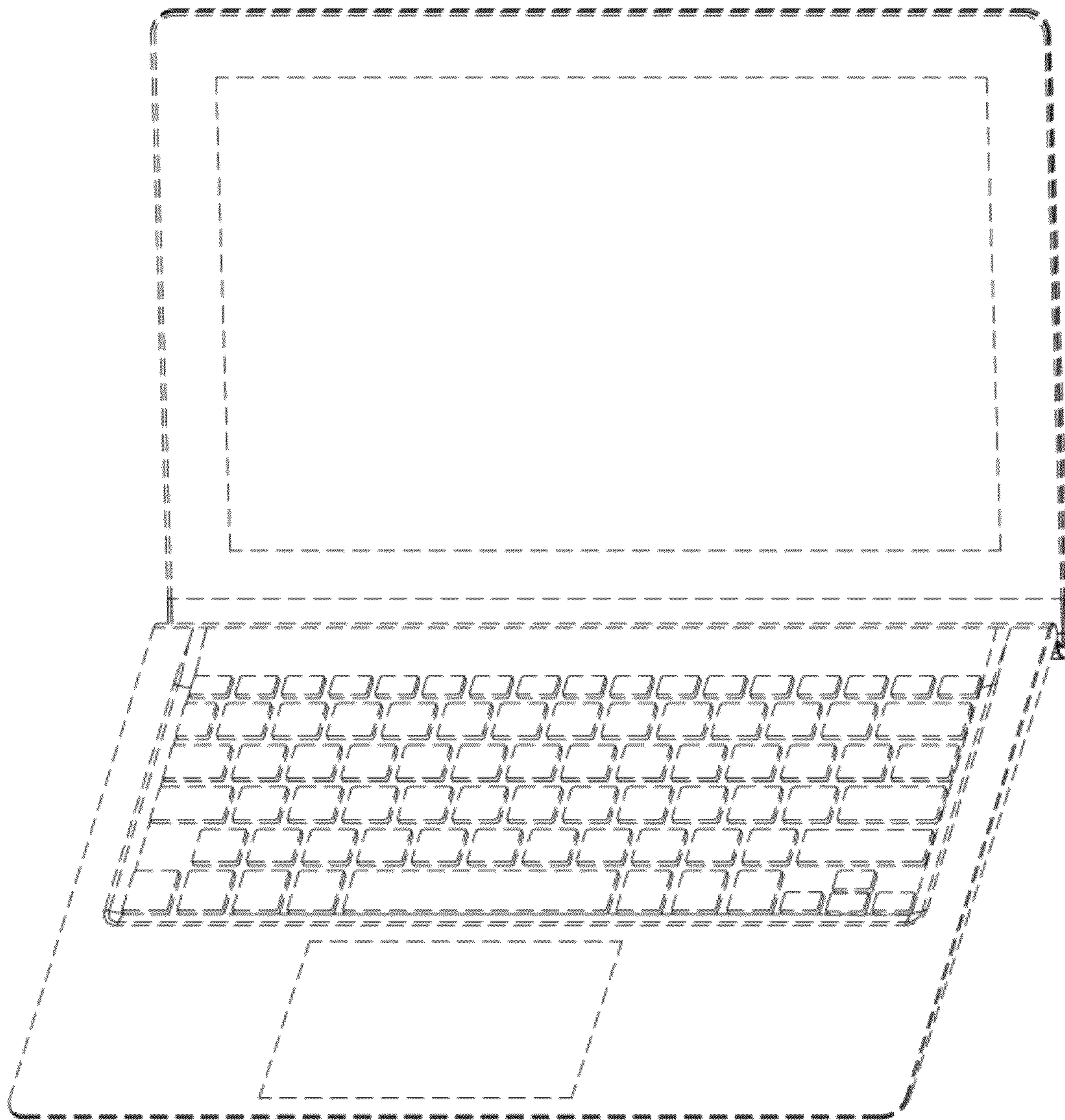

FIG. 7

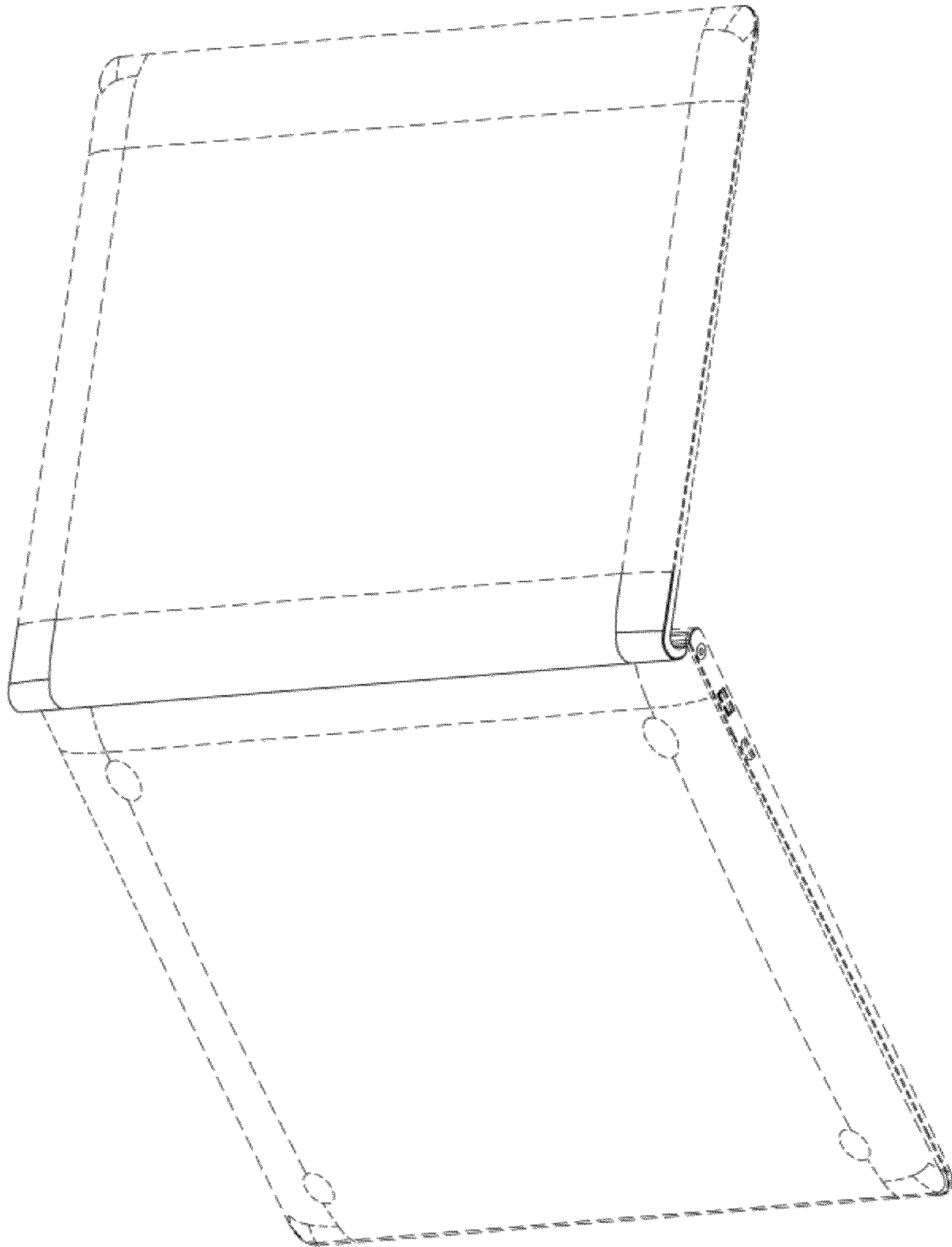

FIG. 8

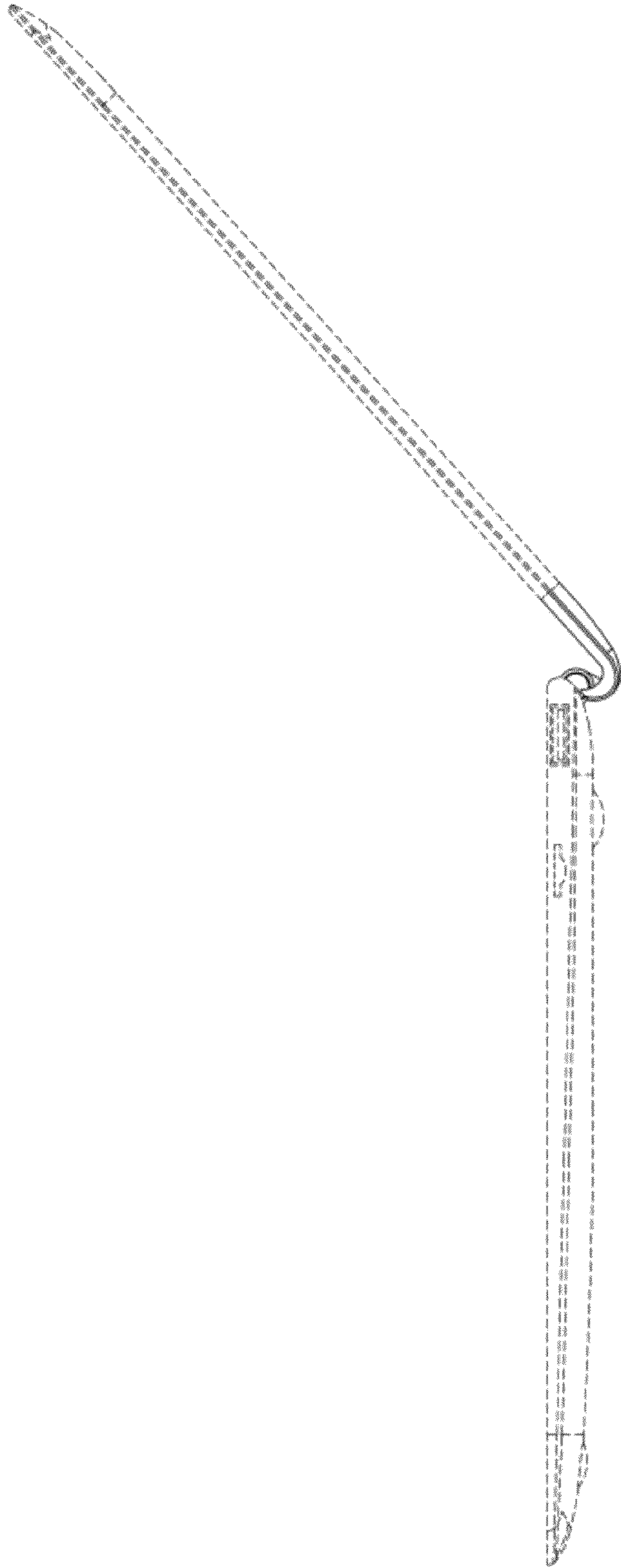

FIG. 9