



US00D664932S

(12) **United States Design Patent**
Sedic

(10) **Patent No.:** **US D664,932 S**
(45) **Date of Patent:** **** Aug. 7, 2012**

(54) **REMOTE CONTROL FOR PERSONAL MASSAGER**

(75) Inventor: **Filip Sedic**, Shanghai (CN)

(73) Assignee: **LELO Inc.**, San Jose, CA (US)

(**) Term: **14 Years**

(21) Appl. No.: **29/396,677**

(22) Filed: **Jul. 5, 2011**

(51) **LOC (9) Cl.** **14-03**

(52) **U.S. Cl.** **D13/168**

(58) **Field of Classification Search** D13/168;
D10/104.1, 106.1; D14/218; D21/324; D24/214,
D24/215; 340/4.3, 4.42, 12.22, 12.23, 12.24,
340/12.29, 12.3, 13.2, 13.21, 13.24; 341/176;
601/1, 46, 72, 80; 700/17, 65, 83

See application file for complete search history.

(56) **References Cited**

U.S. PATENT DOCUMENTS

D497,882 S *	11/2004	Huang	D13/168
D515,040 S *	2/2006	Jones et al.	D13/168
D602,915 S *	10/2009	Song et al.	D14/218
7,815,582 B2 *	10/2010	Imboden et al.	601/15
D627,306 S *	11/2010	Charleux	D13/168

D632,265 S *	2/2011	Choi et al.	D13/168
D643,412 S *	8/2011	Brady et al.	D14/218
D648,861 S *	11/2011	Chong et al.	D24/215

* cited by examiner

Primary Examiner — Selina Sikder

(74) *Attorney, Agent, or Firm* — Fenwick & West LLP

(57) **CLAIM**

I claim the ornamental design for a remote control for personal massager, as shown and described.

DESCRIPTION

FIG. 1 is a first perspective view of a remote control for personal massager.

FIG. 2 is a second perspective view of the remote control for personal massager.

FIG. 3 is a top view of the remote control for personal massager.

FIG. 4 is a bottom view of the remote control for personal massager.

FIG. 5 is a front view of the remote control for personal massager.

FIG. 6 is a rear view of the remote control for personal massager; and,

FIGS. 7 and 8 are left and right side views, respectively, of the remote control for personal massager.

The broken lines are directed to environment and are for illustrative purposes only; the broken lines form no part of the claimed design.

1 Claim, 4 Drawing Sheets

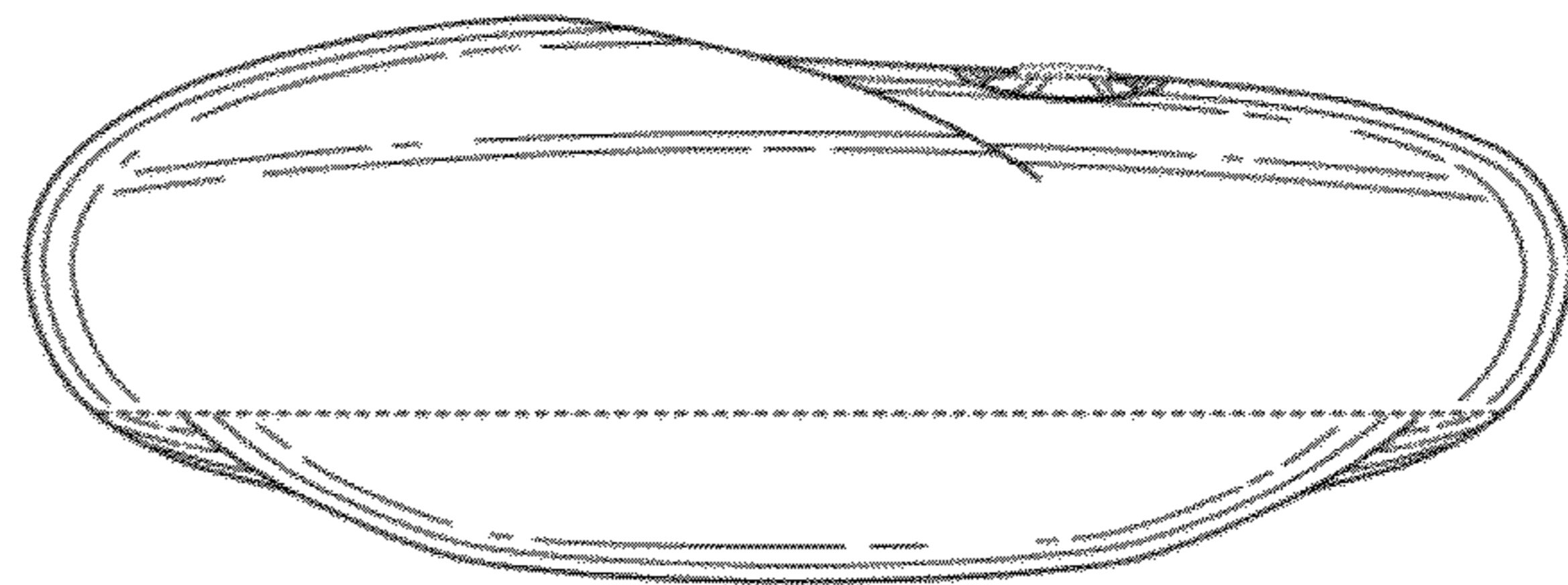
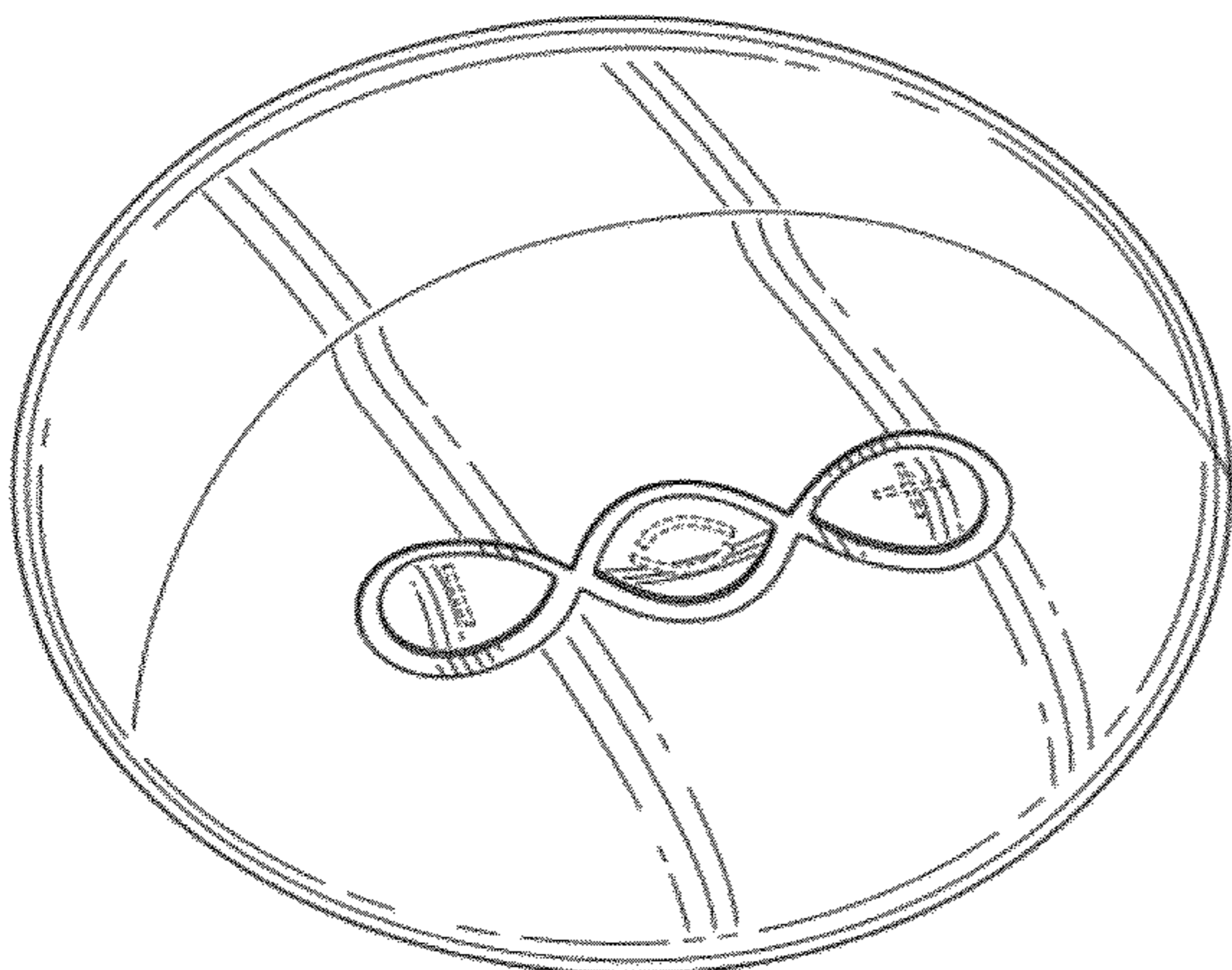

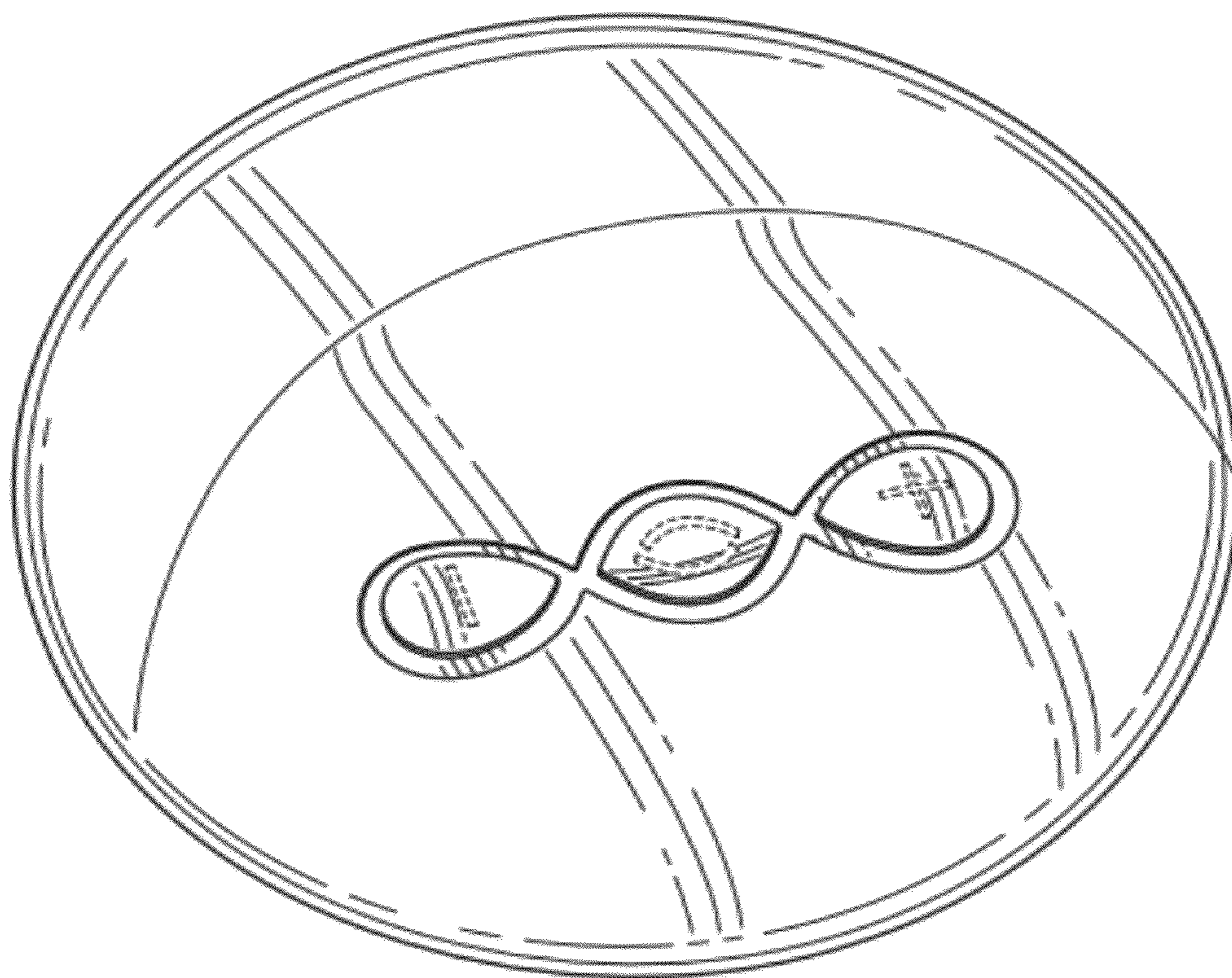

FIG. 1

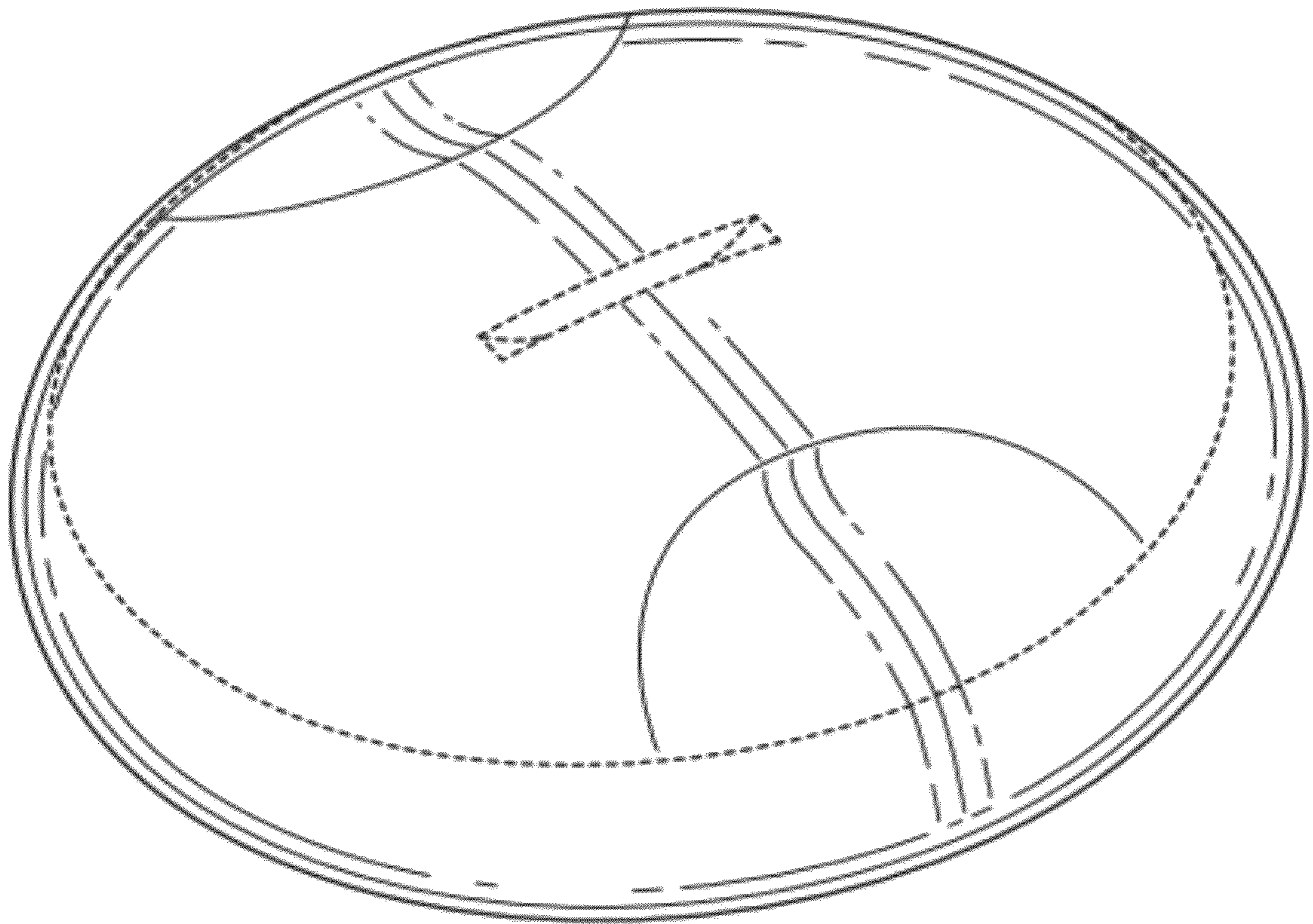

FIG. 2

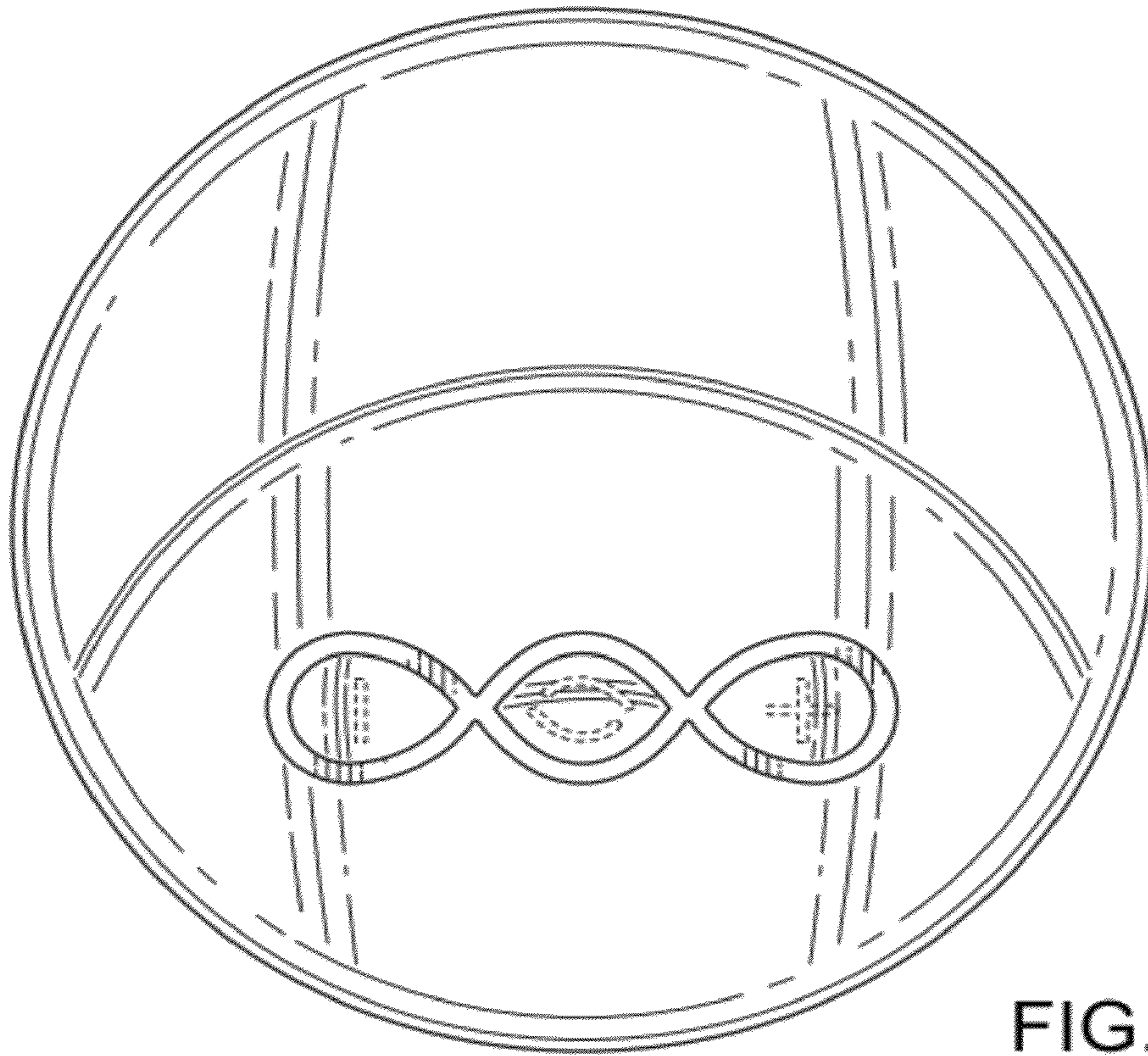

FIG. 3

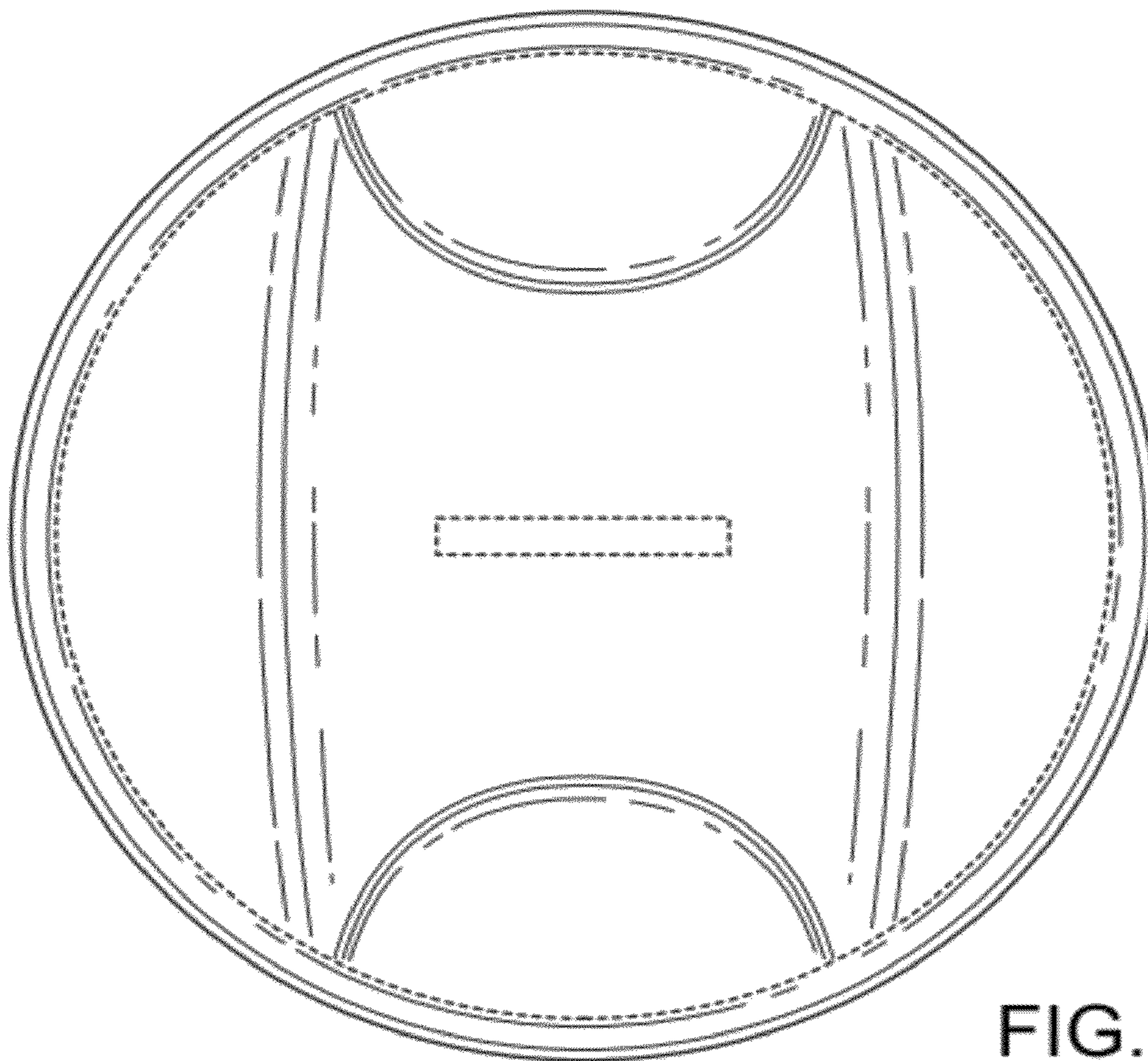

FIG. 4

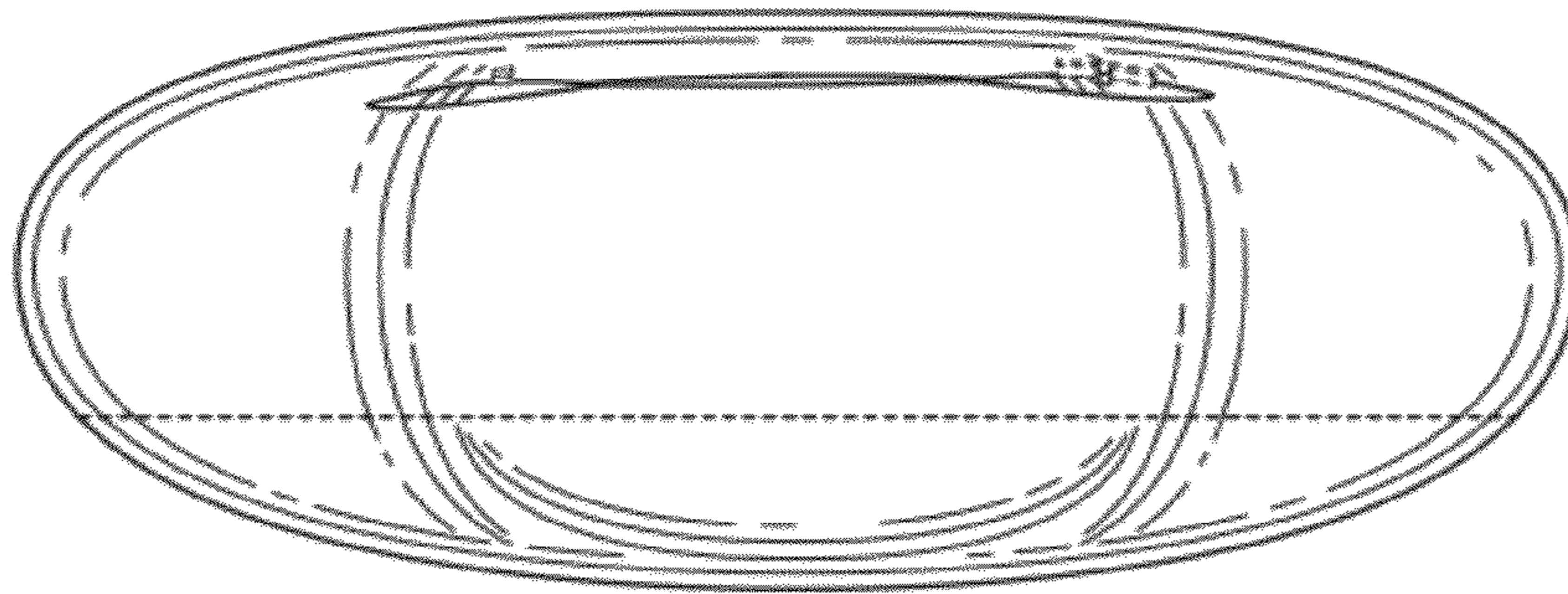

FIG. 5

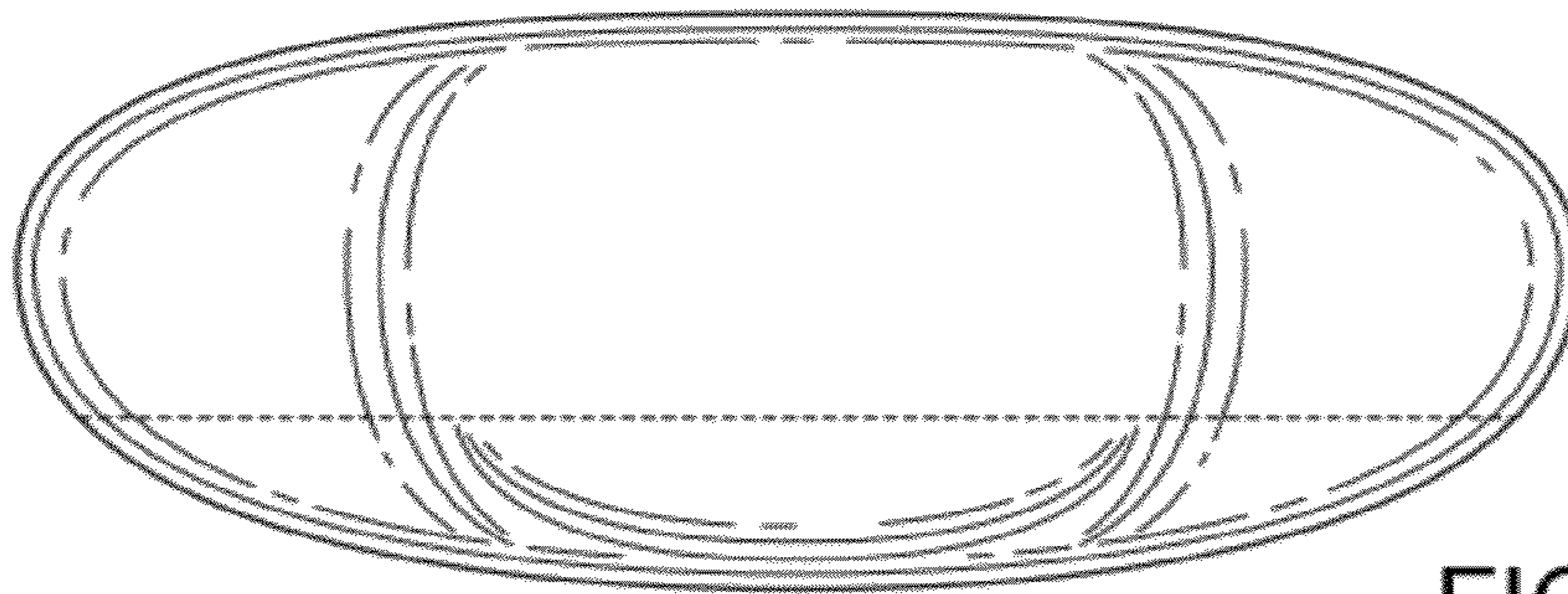

FIG. 6

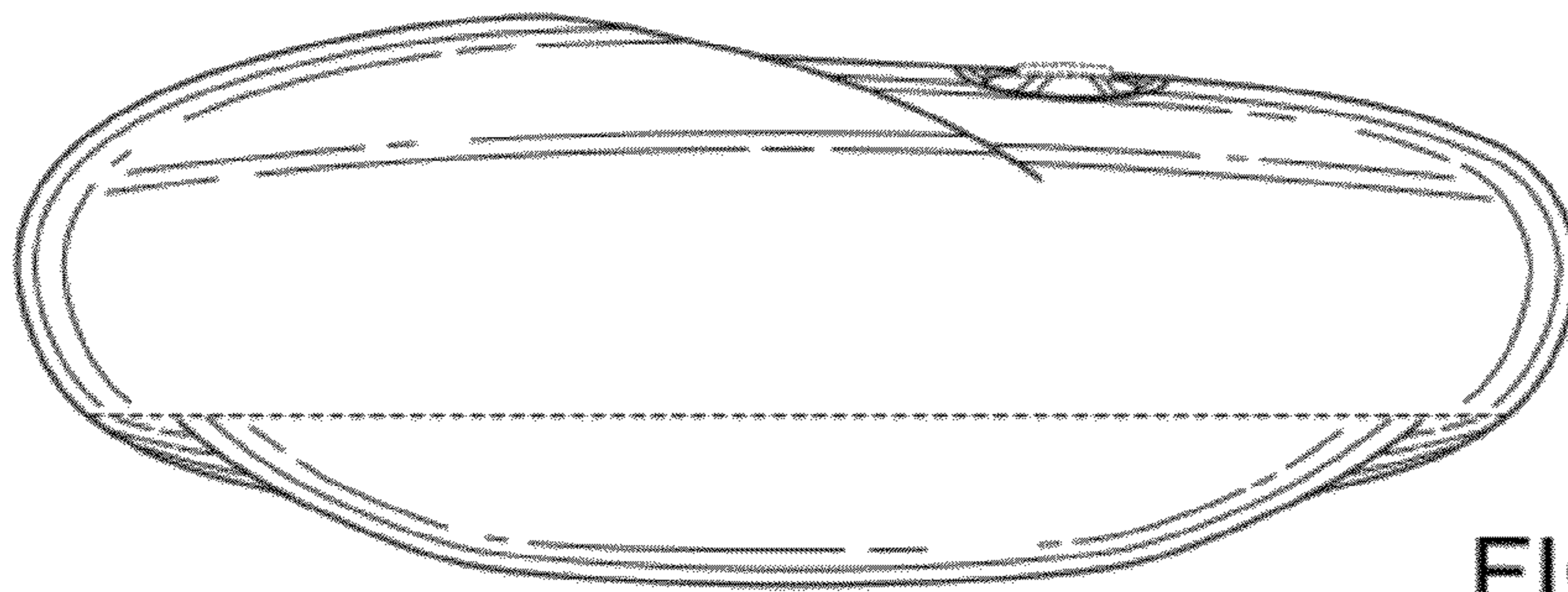

FIG. 7

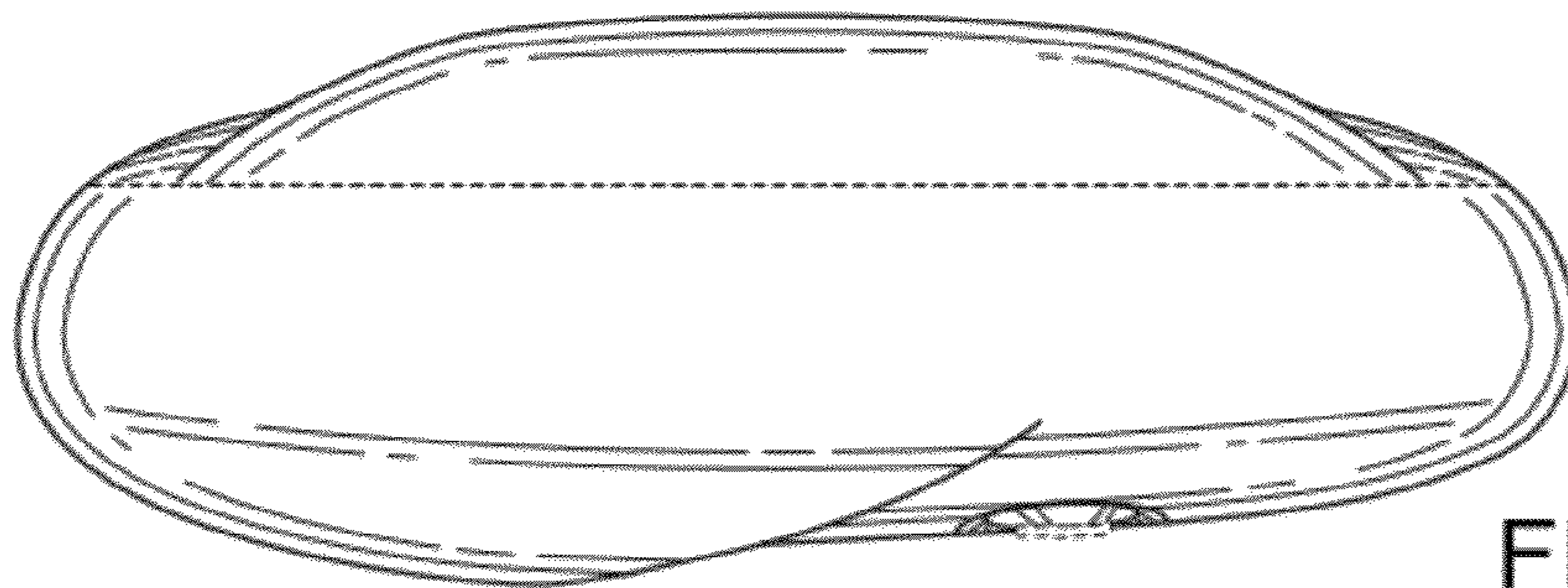

FIG. 8