

US00D664890S

(12) **United States Design Patent**  
**Featherston**

(10) **Patent No.:** **US D664,890 S**

(45) **Date of Patent:** **\*\* \*Aug. 7, 2012**

(54) **STRAP**

(76) **Inventor:** **Tami L. Featherston**, Grain Valley, MO (US)

(\*) **Notice:** This patent is subject to a terminal disclaimer.

(\*\*) **Term:** **14 Years**

(21) **Appl. No.:** **29/387,381**

(22) **Filed:** **Mar. 11, 2011**

(51) **LOC (9) Cl.** ..... **02-07**

(52) **U.S. Cl.** ..... **D11/201**

(58) **Field of Classification Search** ..... D11/1-2, D11/200-201, 206-210, 214-218, 85, 212; 24/163 R, 169-171, 173, 177-179, 191, 194-195, 24/197, 200, 614-616, 625, 68 CD, 265 A, 24/690; 248/75, 92, 499; D6/578; D2/624  
See application file for complete search history.

(56) **References Cited**

**U.S. PATENT DOCUMENTS**

489,727	A	*	1/1893	Baldwin	.....	24/690
D41,284	S	*	4/1911	Bienenzucht	.....	D11/85
2,140,333	A	*	12/1938	Reiter	.....	24/265 A
D149,976	S	*	6/1948	Sanford	.....	D2/624
D237,760	S	*	11/1975	Woods	.....	D29/122
D246,141	S	*	10/1977	Mazur	.....	D11/212
D306,272	S	*	2/1990	Kruger	.....	D11/212
D314,533	S	*	2/1991	Fossum	.....	D11/210
5,063,641	A	*	11/1991	Chuan	.....	24/197
5,144,724	A	*	9/1992	Chuan	.....	24/68 CD

D349,180	S	*	8/1994	Oldham	.....	D2/624
5,439,265	A	*	8/1995	Plante	.....	294/152
D396,827	S	*	8/1998	Luk	.....	D11/212
D410,775	S	*	6/1999	Halbot, Jr.	.....	D3/254
D470,793	S	*	2/2003	Horn et al.	.....	D11/200
D513,034	S	*	12/2005	Boron et al.	.....	D17/20
D541,190	S	*	4/2007	Plzak	.....	D11/200
D629,331	S	*	12/2010	Kalbach	.....	D11/215
D635,892	S	*	4/2011	Beebe	.....	D11/216

\* cited by examiner

*Primary Examiner* — Ralf Seifert

(74) *Attorney, Agent, or Firm* — Intellectual Property Center, LLC; Aurthur K. Shaffer

(57) **CLAIM**

The ornamental design for a strap, as shown and described.

**DESCRIPTION**

FIG. 1 is a partial top perspective view of a strap in accordance with the present invention;

FIG. 2 is a partial top plan view of the strap of FIG. 1;

FIG. 3 is a partial right elevational view of the strap of FIG. 1;

FIG. 4 is front elevational view of the strap of FIG. 1;

FIG. 5 is a partial bottom plan view of the strap of FIG. 1;

FIG. 6 is a partial left elevational view of the strap of FIG. 1; and,

FIG. 7 is a rear elevational view of the strap of FIG. 1.

Portions of FIGS. 1-3, 5-6 are shown as partial fragmented views and portions of FIGS. 1, 2 and 5 have shading lines for illustrative purposes only and form no part of the claimed design.

**1 Claim, 3 Drawing Sheets**

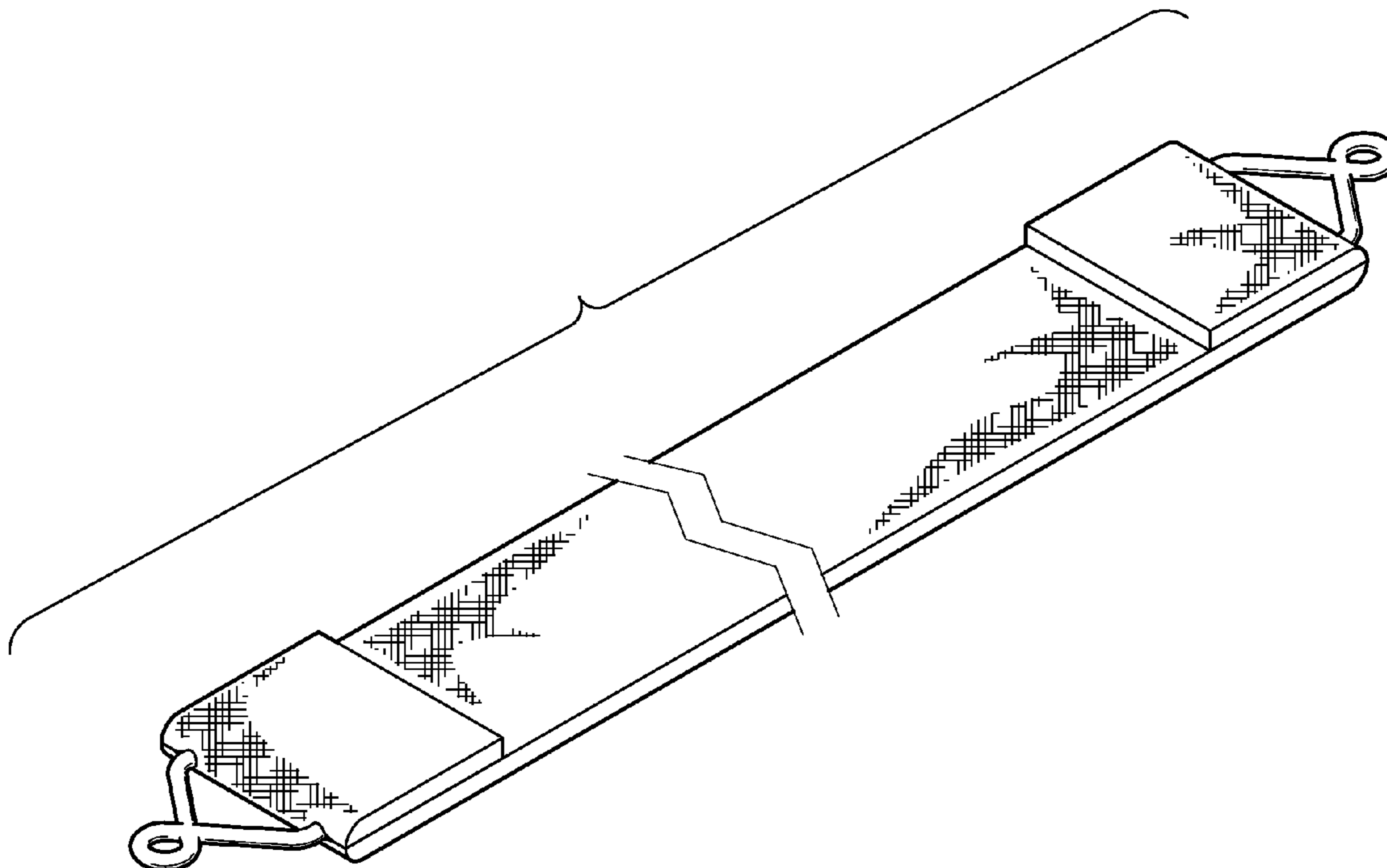

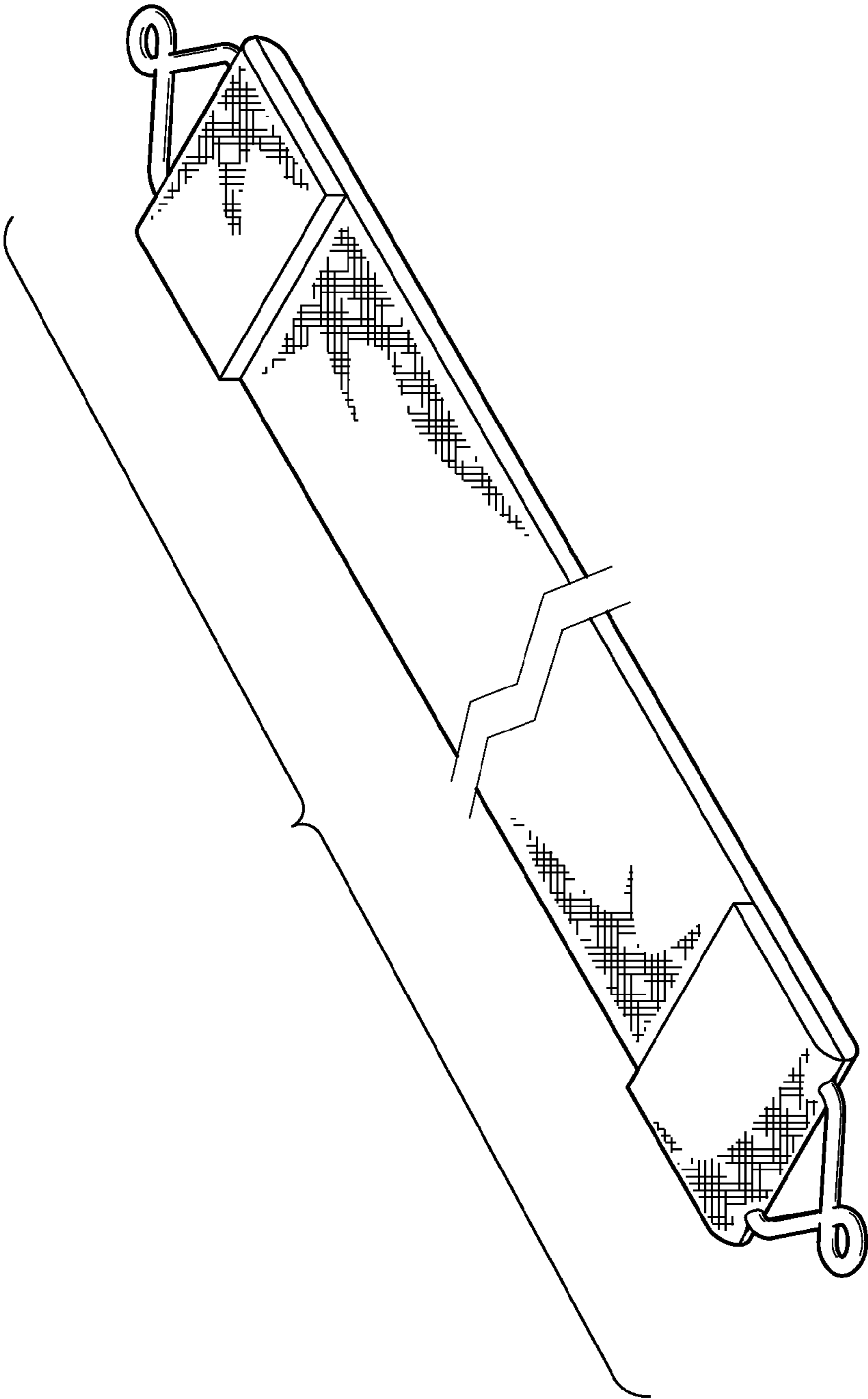

FIG. 1

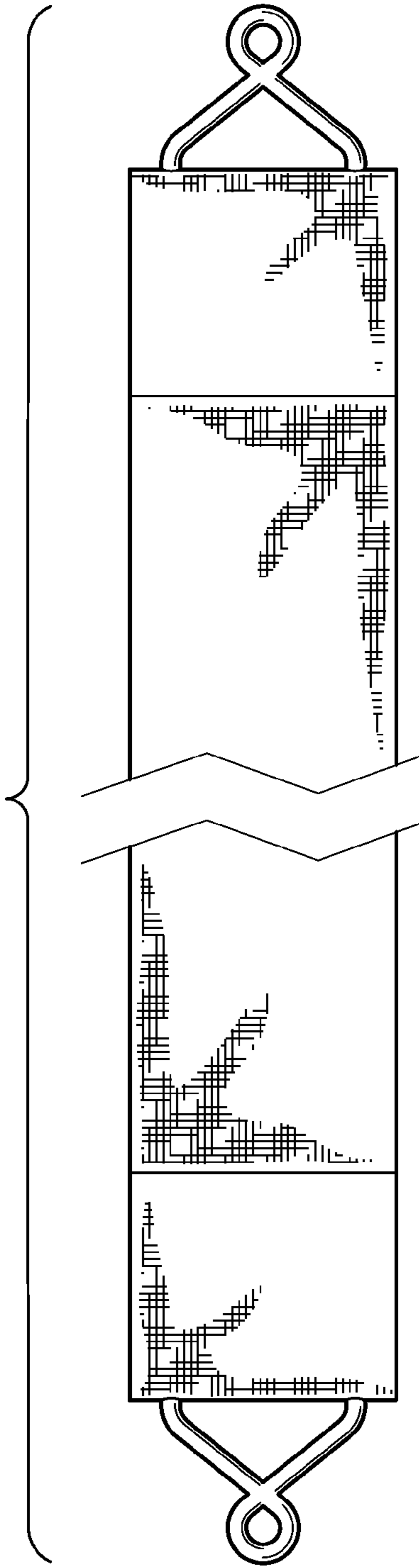

FIG. 2

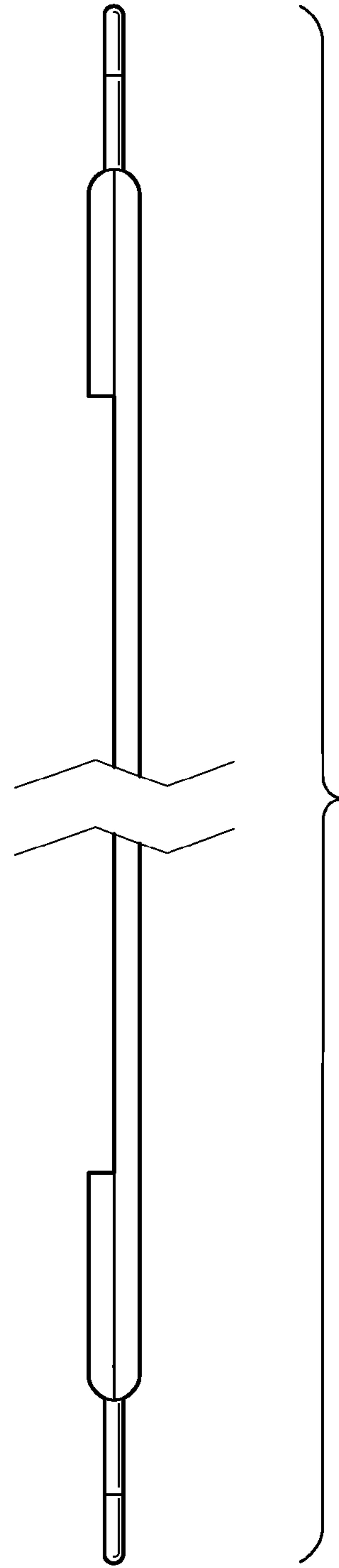

FIG. 3



FIG. 4

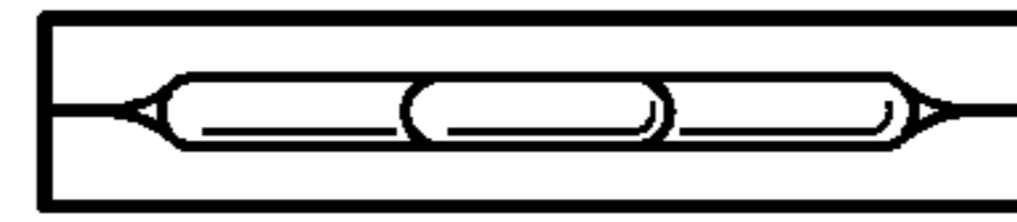

FIG. 7

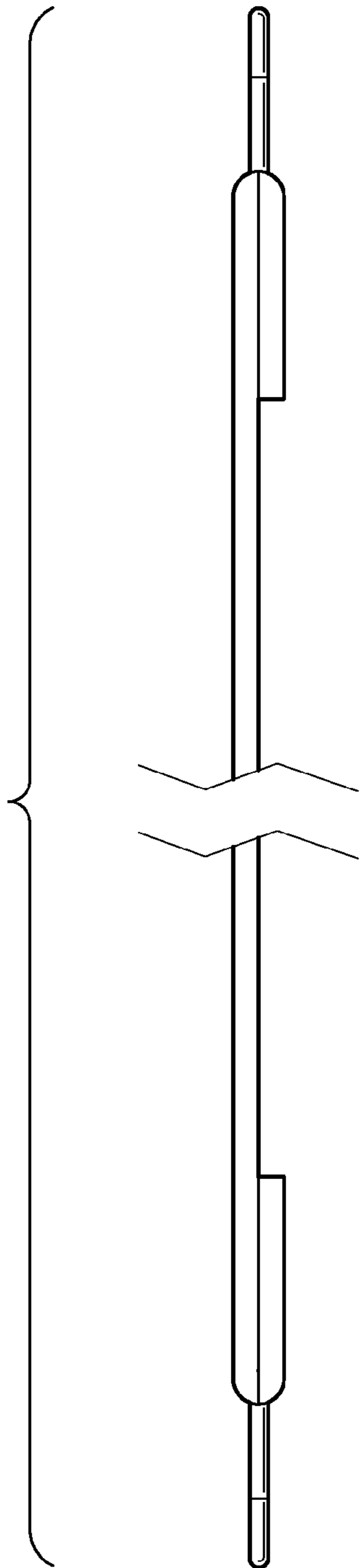

FIG. 6

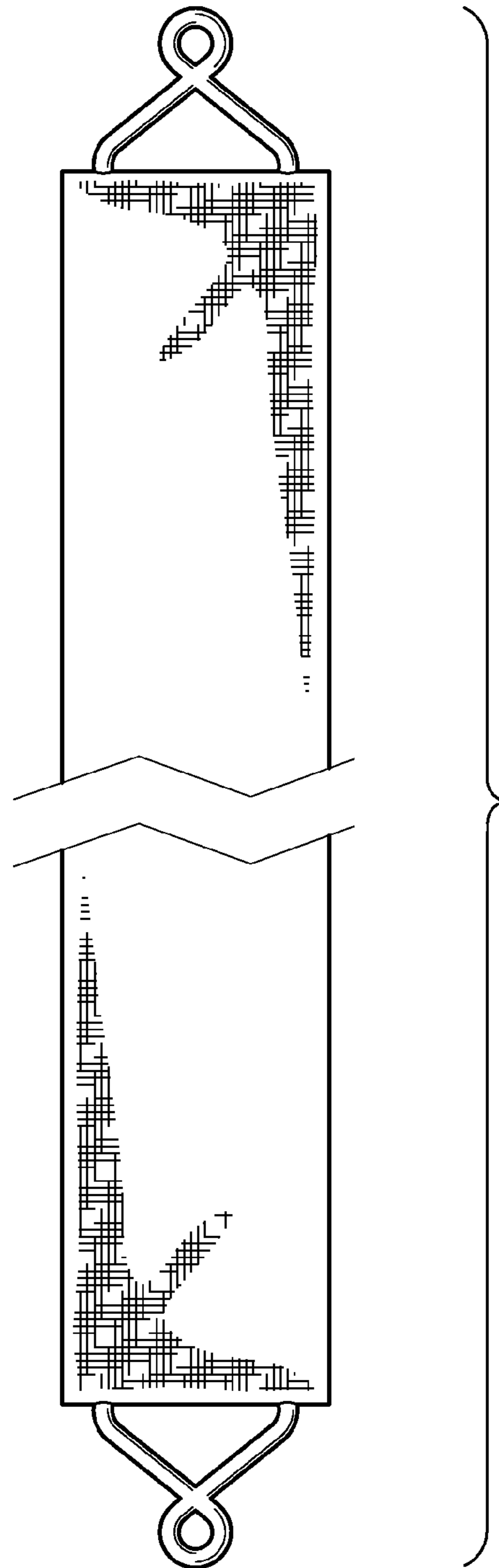

FIG. 5