

US00D664879S

(12) **United States Design Patent**
Behling

(10) **Patent No.:** **US D664,879 S**
(45) **Date of Patent:** **** Aug. 7, 2012**

(54) **WATCH DIAL**

(75) **Inventor:** **Christoph Behling**, London (GB)

(73) **Assignee:** **LVMH Swiss Manufactures SA**, La Chaux-de-Fonds (CH)

(**) **Term:** **14 Years**

(21) **Appl. No.:** **29/402,164**

(22) **Filed:** **Sep. 21, 2011**

(30) **Foreign Application Priority Data**

Mar. 21, 2011 (CH) 594322801

(51) **LOC (9) Cl.** **10-07**

(52) **U.S. Cl.** **D10/126**

(58) **Field of Classification Search** D10/30-39,
D10/122-132; 368/276, 281, 282, 285, 223,
368/228, 232

See application file for complete search history.

(56) **References Cited**

U.S. PATENT DOCUMENTS

- D360,141 S * 7/1995 Scheufele D10/32
- D371,079 S * 6/1996 Mijatovic D10/39
- D417,160 S * 11/1999 Fedele D10/32
- D459,241 S * 6/2002 Bodino D10/32
- D473,473 S * 4/2003 Wunderman D10/32
- D502,120 S * 2/2005 Nataf D10/126
- D517,432 S * 3/2006 Laucella D10/39

- D528,032 S * 9/2006 Lovegrove D10/126
- D528,454 S * 9/2006 Behling D10/126
- D578,904 S * 10/2008 Calvani D10/39
- D616,782 S * 6/2010 Chastaingt D10/126
- D634,653 S * 3/2011 Laucella D10/39
- D650,710 S * 12/2011 Laucella D10/39

* cited by examiner

Primary Examiner — Lucy Lieberman

(74) *Attorney, Agent, or Firm* — Mark S. Leonardo; Brown Rudnick LLP

(57) **CLAIM**

The ornamental design for a watch dial, as shown and described.

DESCRIPTION

FIG. 1 illustrates a perspective view of a watch dial employing an ornamental design in accordance with the present invention;

FIG. 2 illustrates a front plan view of the watch dial of FIG. 1; FIG. 3 illustrates a back plan view of the watch dial of FIG. 1; FIG. 4 illustrates a left side plan view of the watch dial of FIG. 1;

FIG. 5 illustrates a right side plan view of the watch dial of FIG. 1;

FIG. 6 illustrates a top plan view of the watch dial of FIG. 1; and,

FIG. 7 illustrates a bottom plan view of the watch dial of FIG. 1.

The broken lines in FIG. 3 are used to show portions of the watch dial that do not form part of the claimed design.

1 Claim, 7 Drawing Sheets

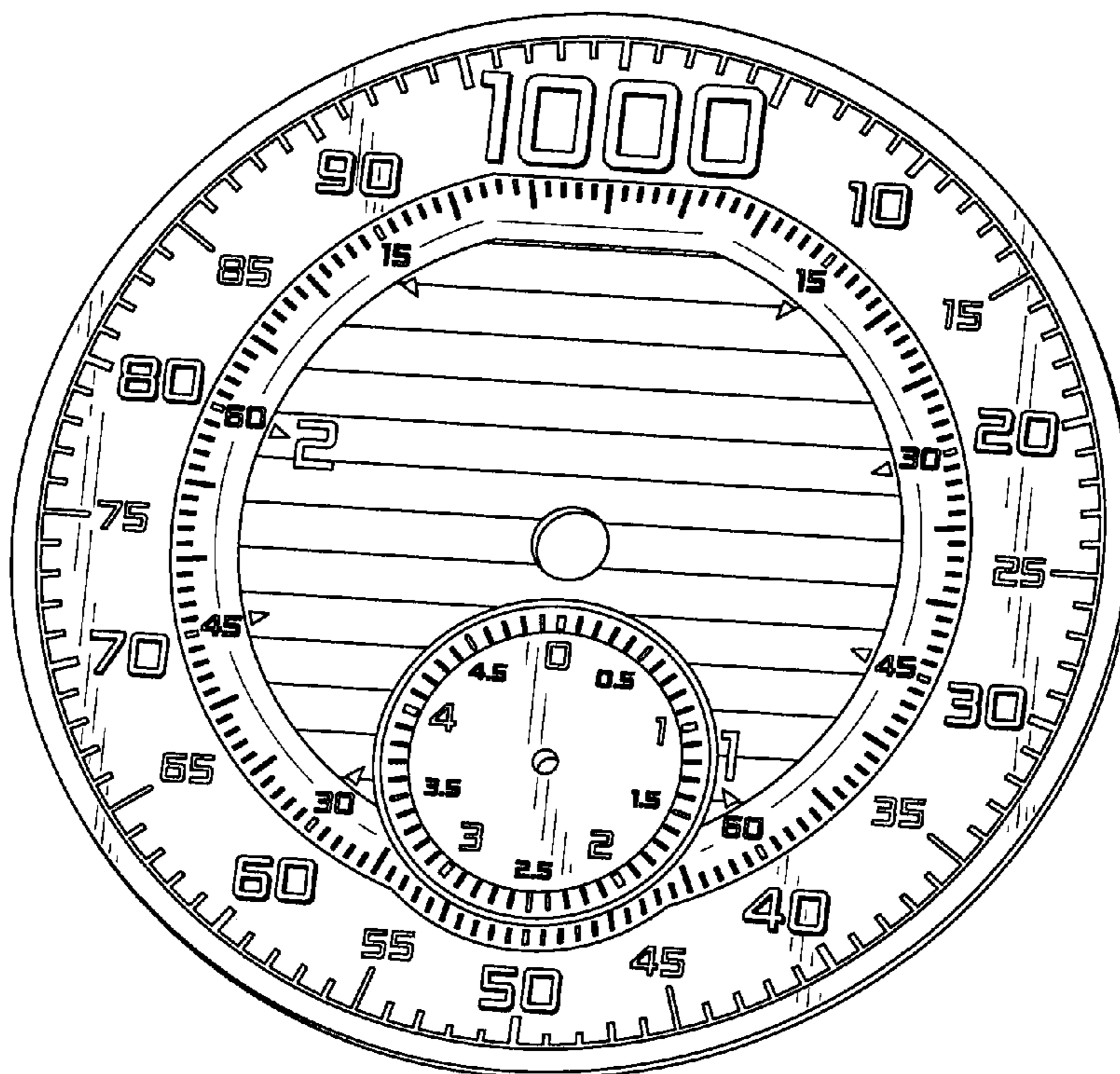

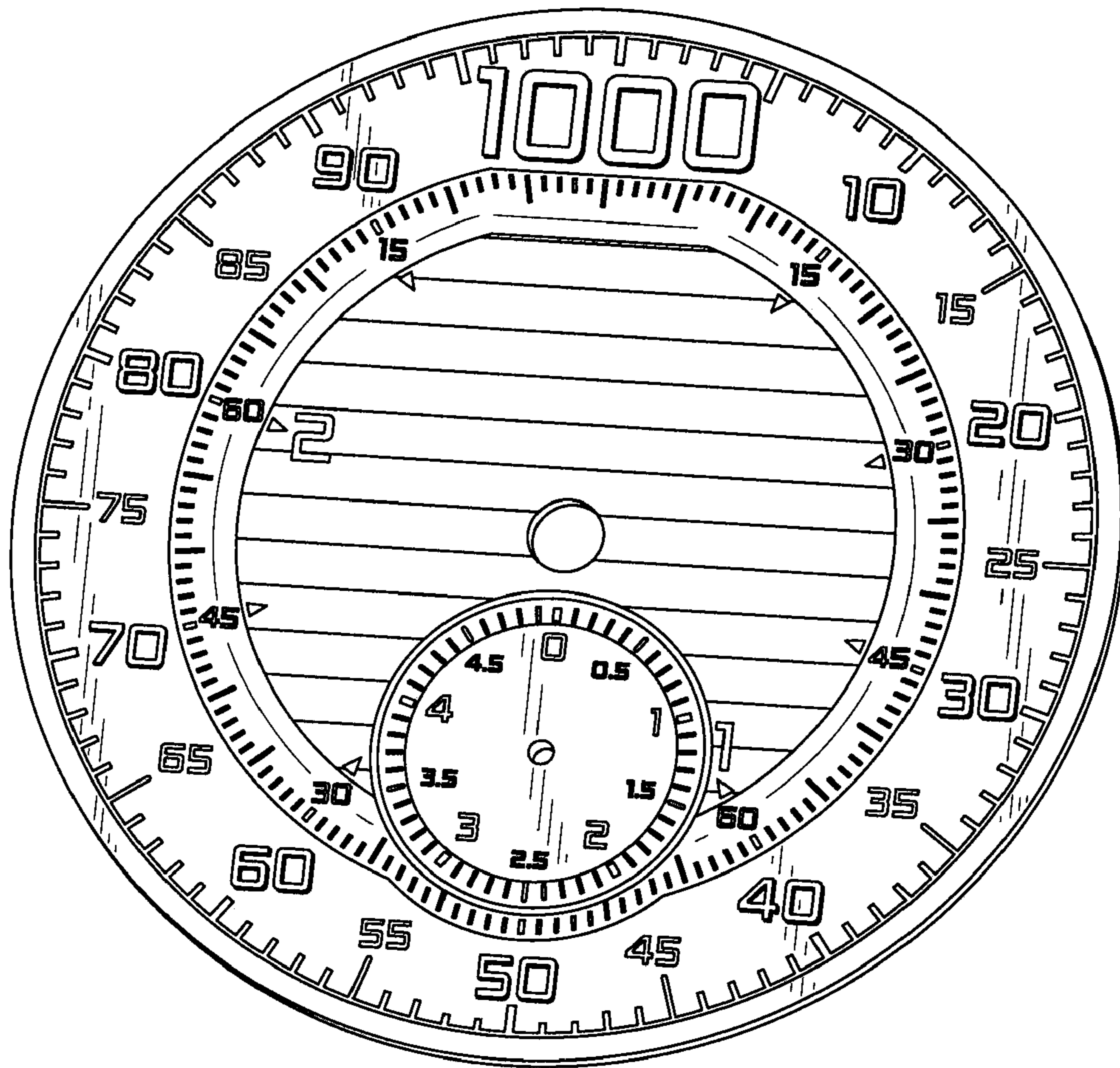

FIG. 1

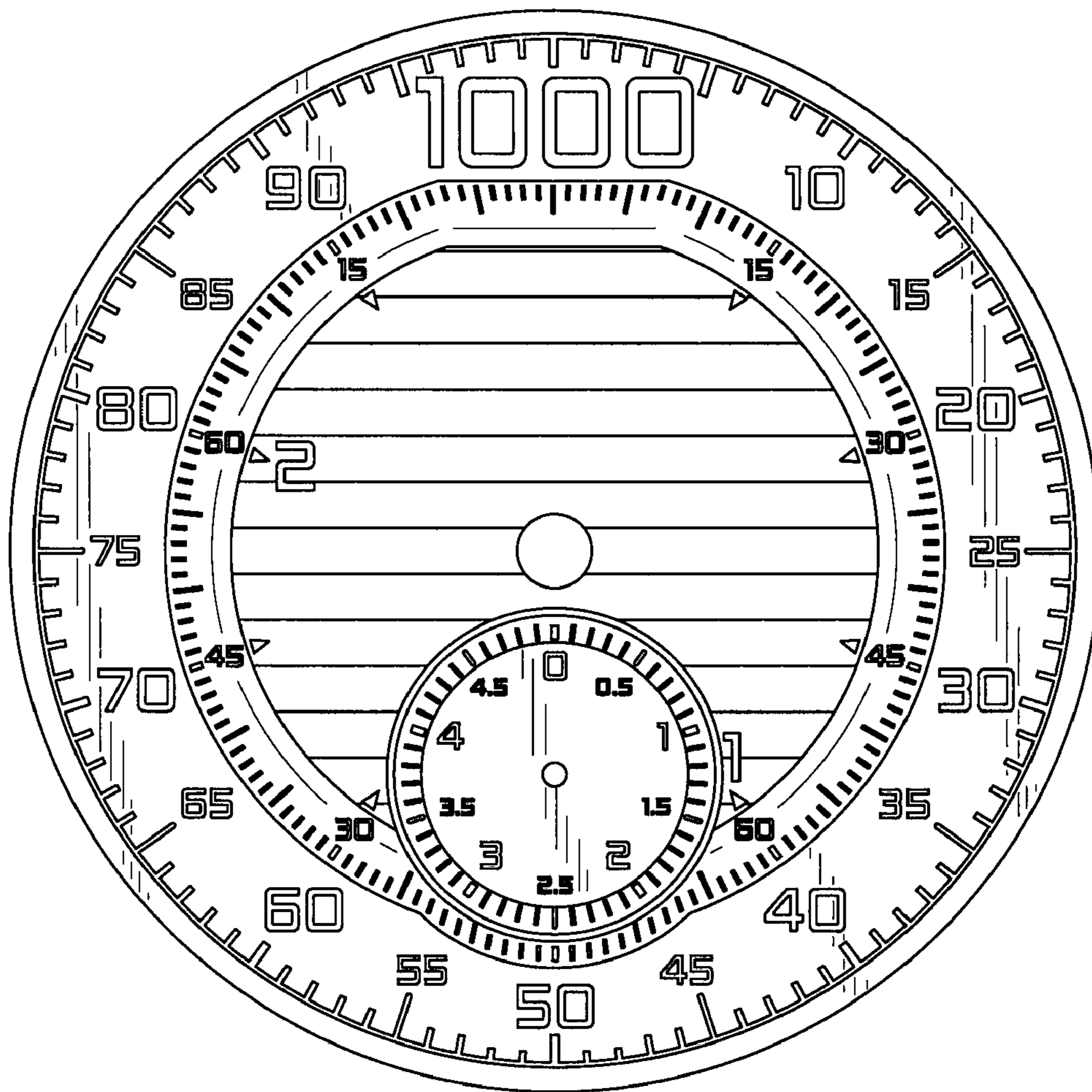

FIG. 2

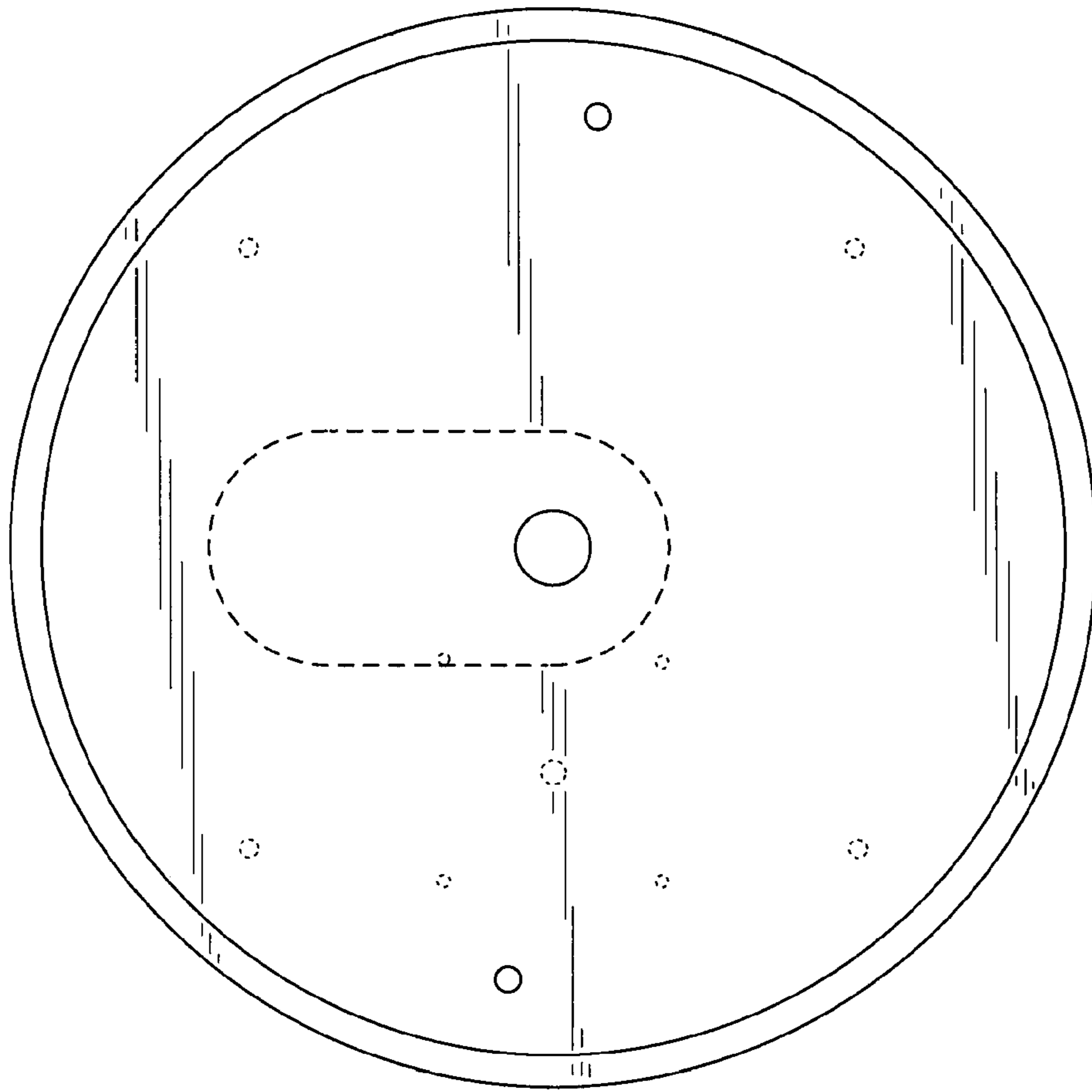

FIG.3

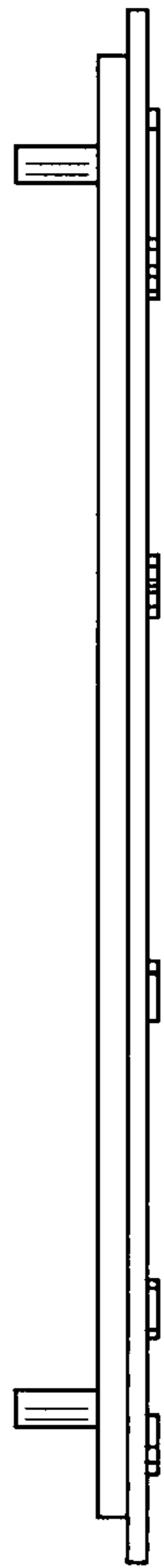

FIG.4

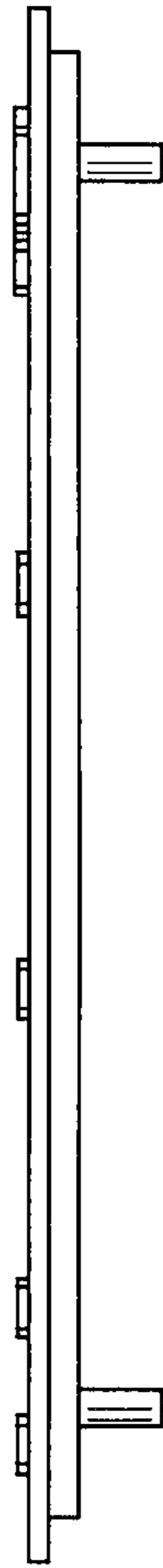

FIG.5

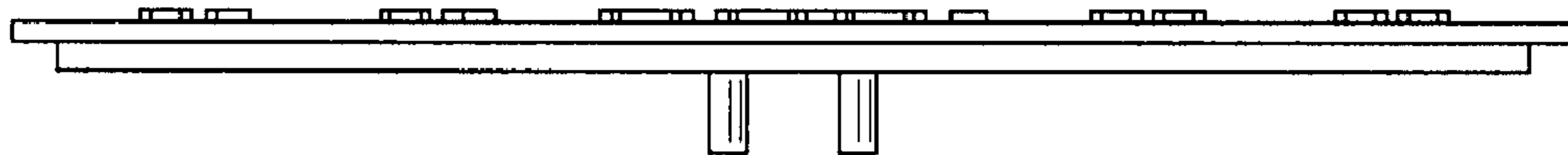

FIG.6

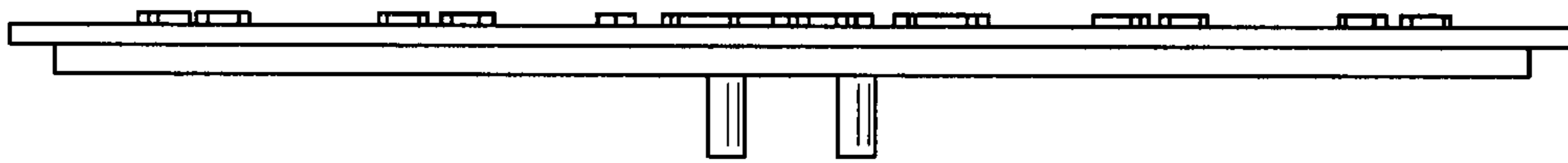

FIG. 7