

US00D664867S

(12) **United States Design Patent**
Graff

(10) **Patent No.:** **US D664,867 S**

(45) **Date of Patent:** **** Aug. 7, 2012**

(54) **WATCH CASE**

(75) **Inventor:** **Laurence Graff, Gstaad (CH)**

(73) **Assignee:** **Venberg SA, Geneva (CH)**

(**) **Term:** **14 Years**

(21) **Appl. No.:** **29/414,218**

(22) **Filed:** **Feb. 27, 2012**

(30) **Foreign Application Priority Data**

Aug. 31, 2011 (WO) DM/076 772

(51) **LOC (9) Cl.** **10-02**

(52) **U.S. Cl.** **D10/38**

(58) **Field of Classification Search** D10/30-39;
368/276, 281, 282, 285

See application file for complete search history.

(56) **References Cited**

U.S. PATENT DOCUMENTS

D179,372 S *	12/1956	Bauer	D10/39
D181,013 S *	9/1957	Mamie	D10/38
D302,797 S *	8/1989	Glauser	D10/32
D383,072 S *	9/1997	Visage	D10/30
D384,295 S *	9/1997	Riley	D10/30
D385,804 S *	11/1997	Toribio	D10/30

D527,283 S *	8/2006	De Witt	D10/38
D527,284 S *	8/2006	Buccellati	D10/38
D528,443 S *	9/2006	Bedat	D10/39
D536,268 S *	2/2007	Asakawa et al.	D10/38
D545,910 S *	7/2007	Peraldi	D10/32
D588,944 S *	3/2009	Graff	D10/38
D592,531 S *	5/2009	Wunderman	D10/39
D600,145 S *	9/2009	Schoepfer	D10/38
D607,756 S *	1/2010	Perrenoud	D10/38
D643,315 S *	8/2011	De Witt	D10/39

* cited by examiner

Primary Examiner — Lucy Lieberman

(74) *Attorney, Agent, or Firm* — Clifford W. Browning;
Krieg DeVault LLP

(57) **CLAIM**

The ornamental design for a watch case, as shown and described.

DESCRIPTION

FIG. 1 is a front view of the watch case of the present invention.

FIG. 2 is a rear view of the watch case of FIG. 1.

FIG. 3 is a right side view of the watch case of FIG. 1.

FIG. 4 is a left side view of the watch case of FIG. 1.

FIG. 5 is a top view of the watch case of FIG. 1.

FIG. 6 is a bottom view of the watch case of FIG. 1; and,

FIG. 7 is a right side perspective view of the watch case of FIG. 1.

1 Claim, 1 Drawing Sheet

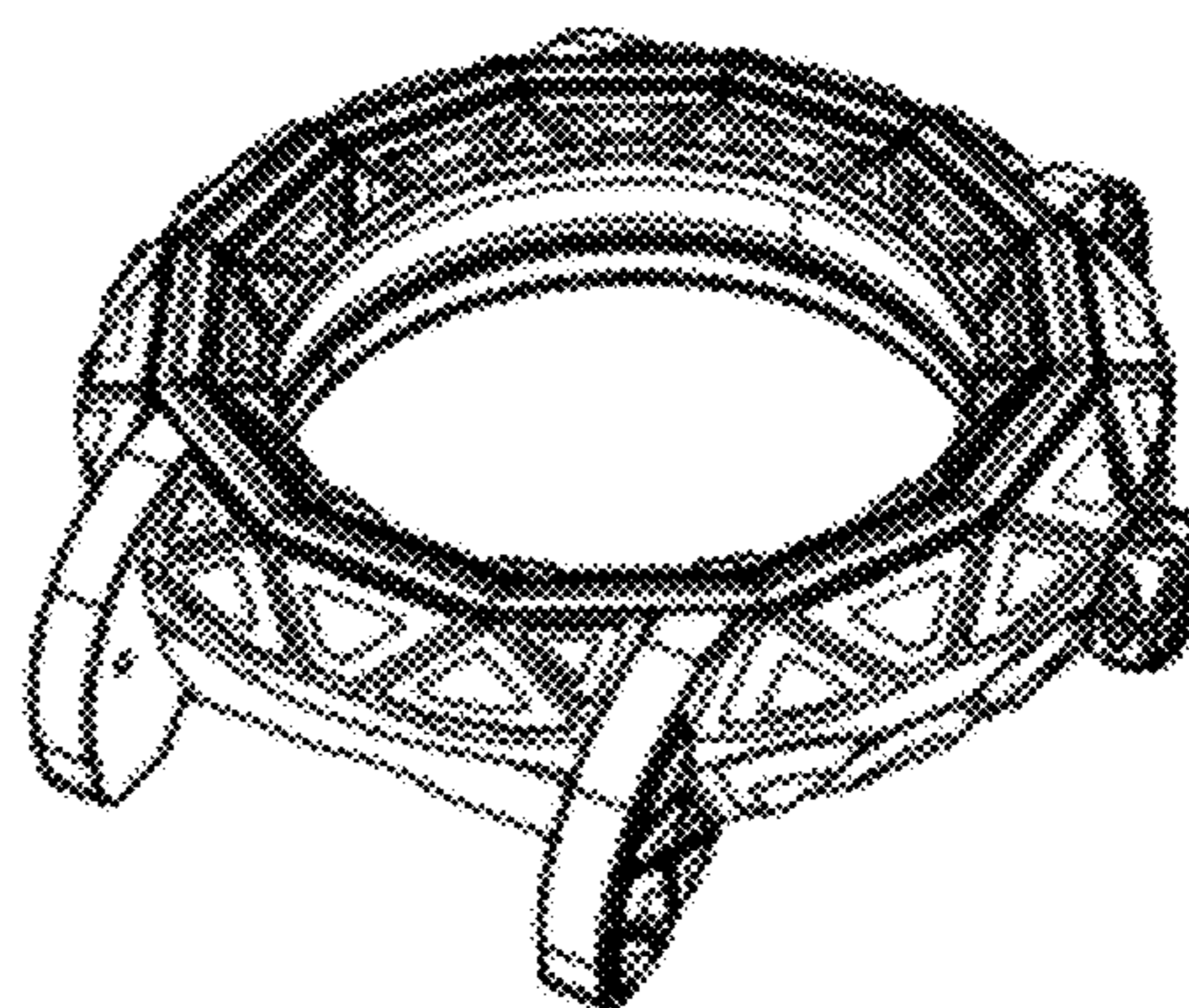
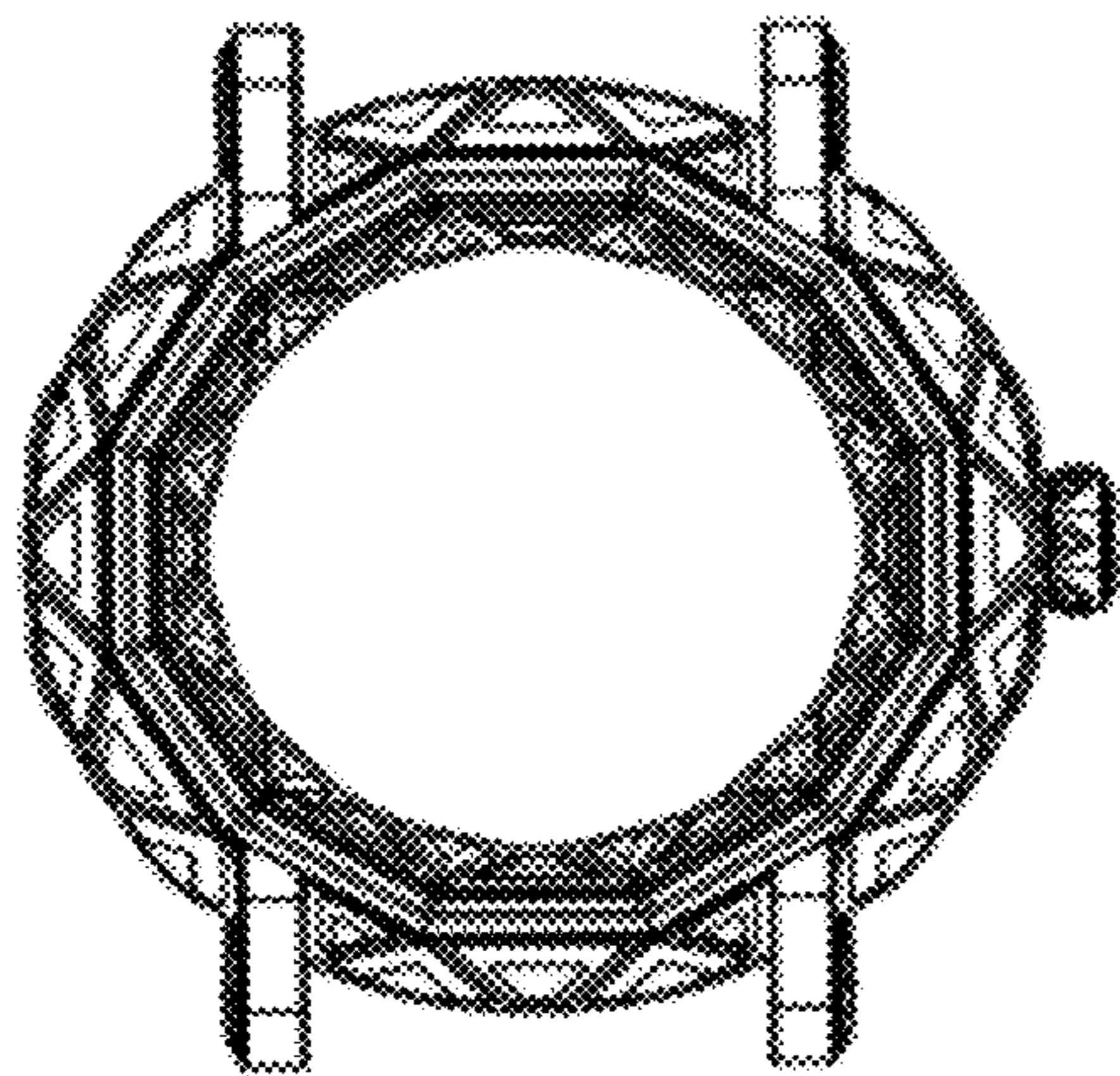



FIG. 1



FIG. 2

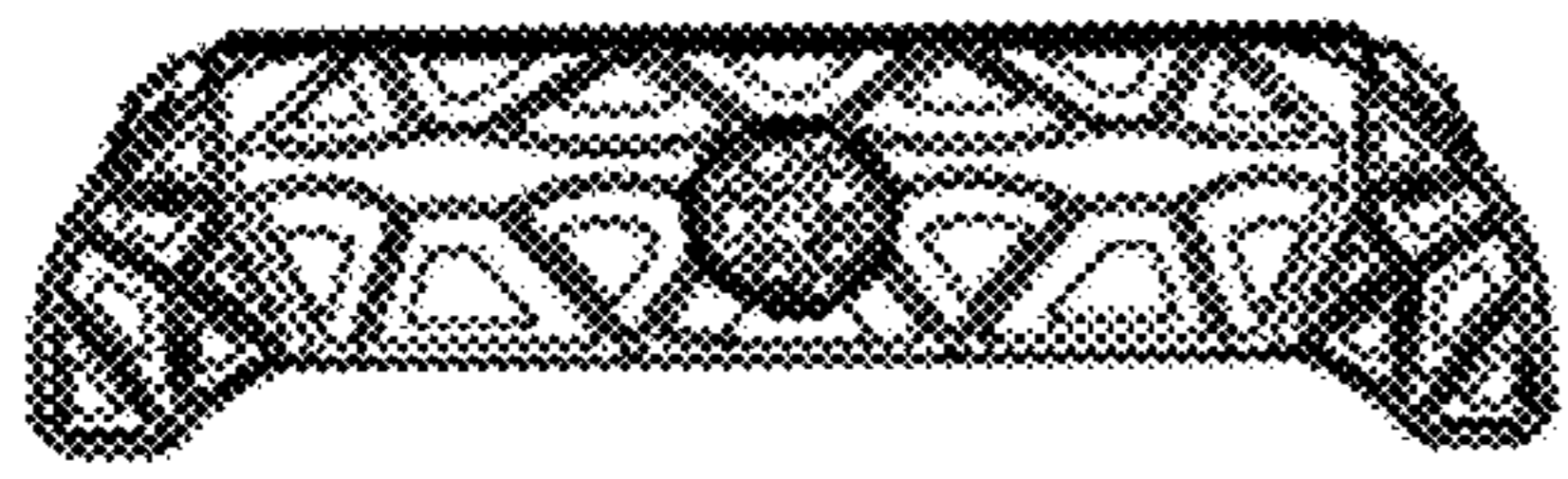

FIG. 3

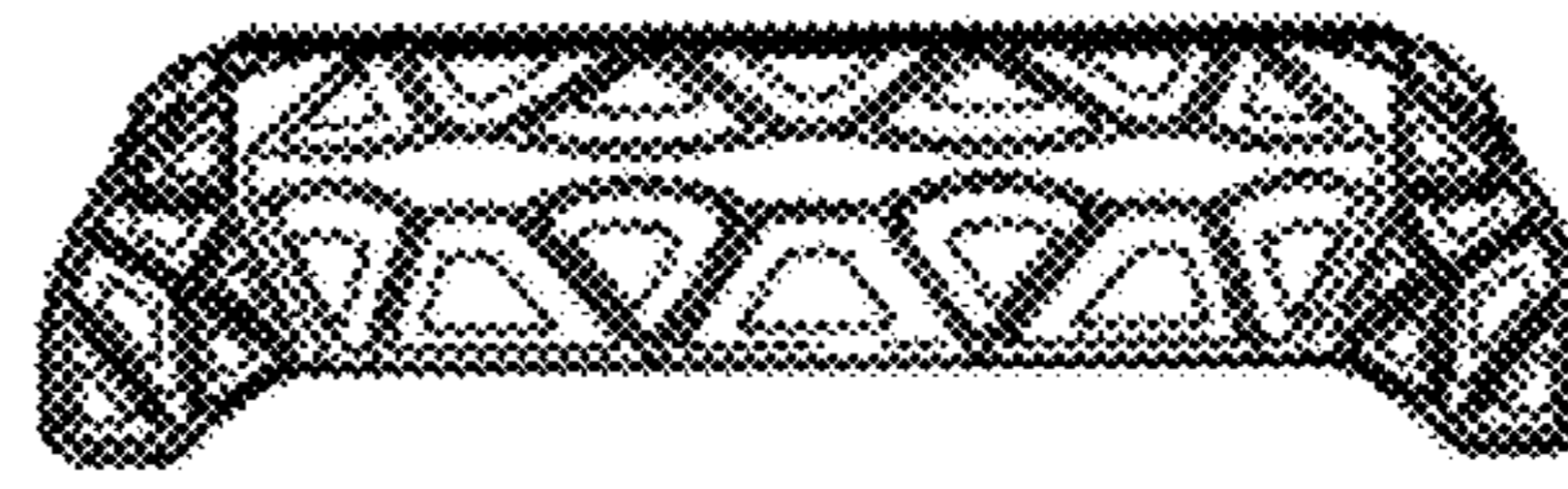

FIG. 4

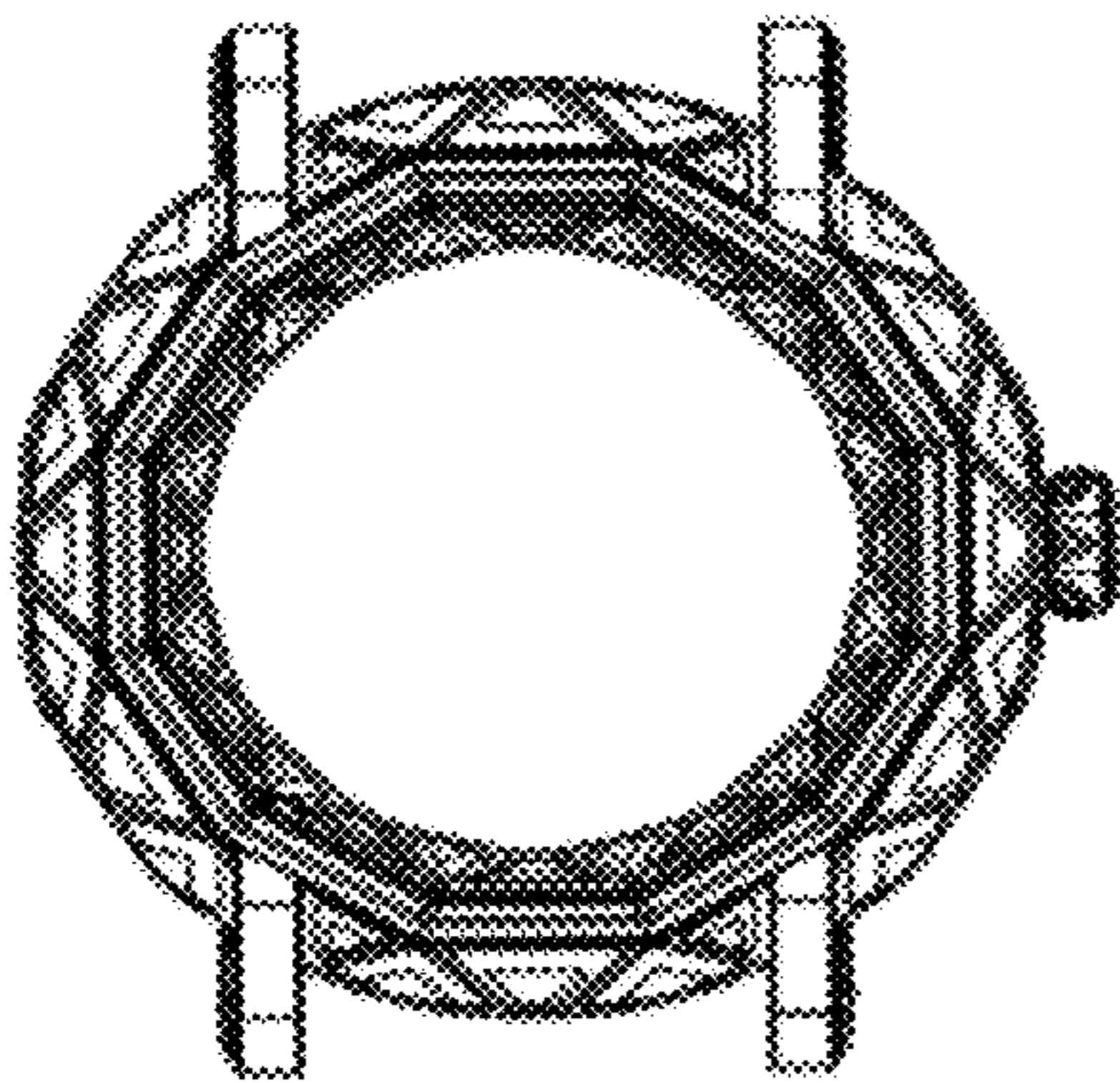

FIG. 5

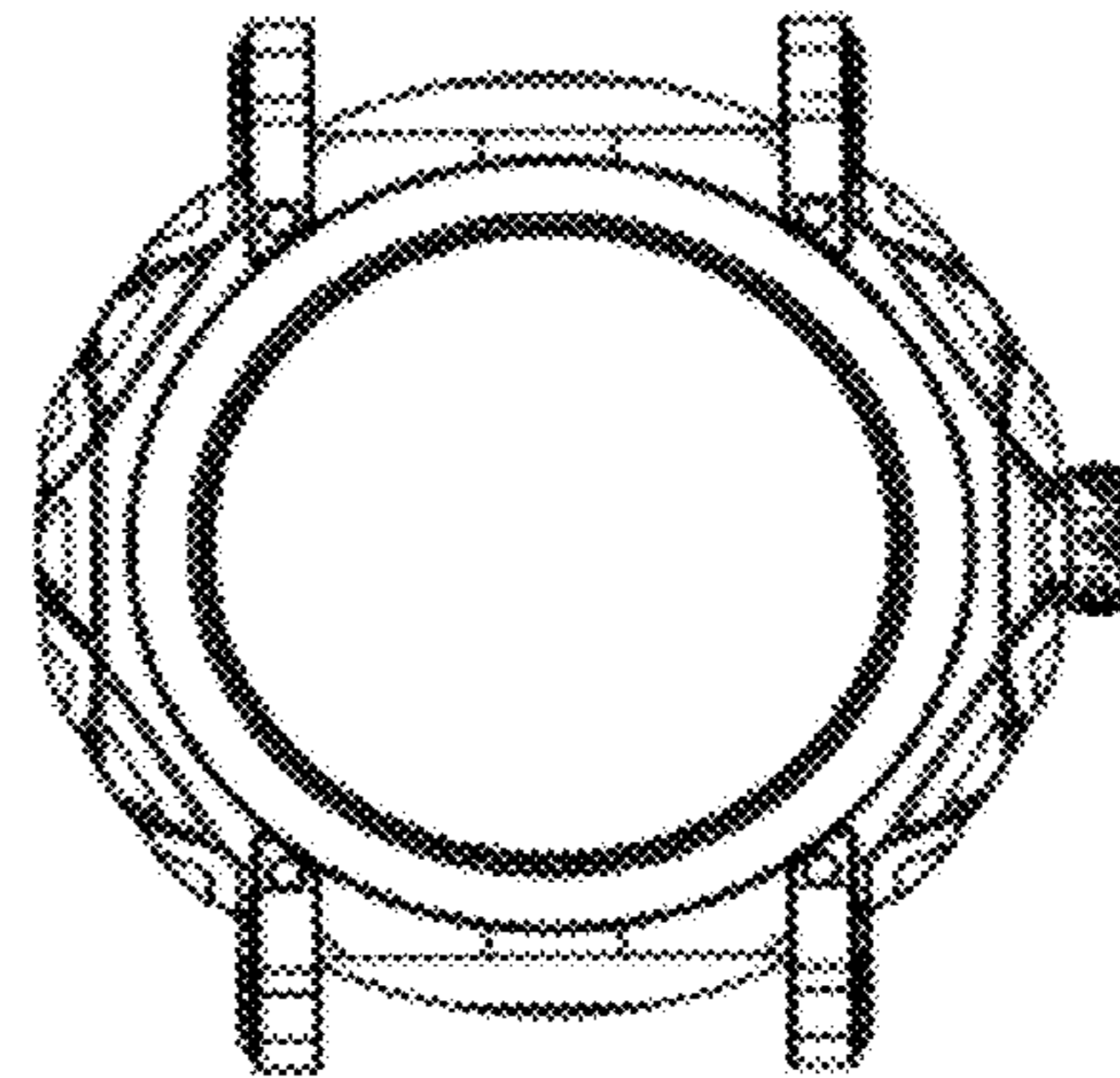

FIG. 6

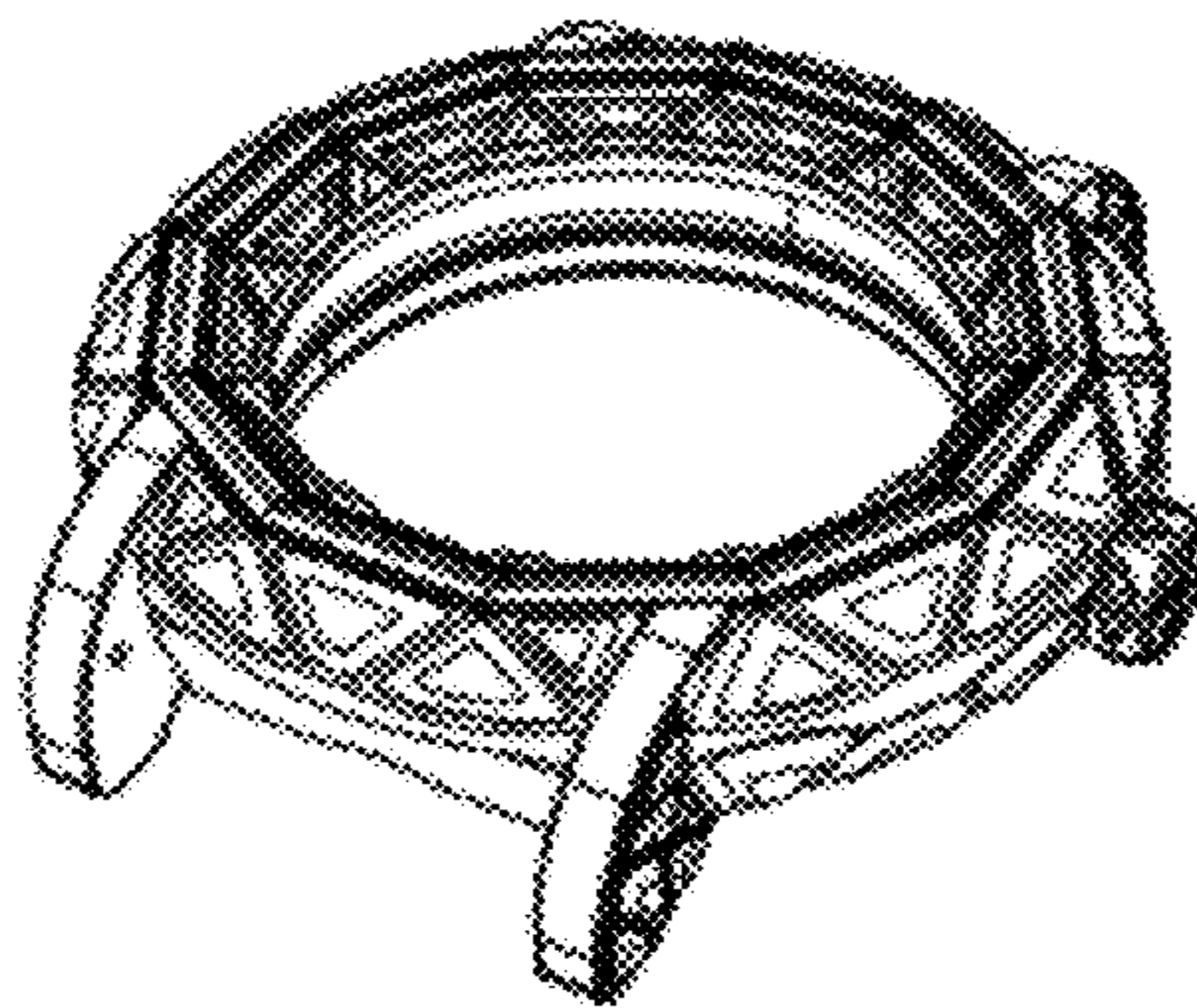

FIG. 7