



US00D664753S

(12) **United States Design Patent**
Santos

(10) **Patent No.:** **US D664,753 S**

(45) **Date of Patent:** **** Aug. 7, 2012**

(54) **FOOTWEAR SOLE**

(75) Inventor: **Katherine Santos**, Lyons, CO (US)

(73) Assignee: **Crocs, Inc.**, Niwot, CO (US)

(**) Term: **14 Years**

(21) Appl. No.: **29/379,401**

(22) Filed: **Nov. 18, 2010**

(51) **LOC (9) Cl.** **02-04**

(52) **U.S. Cl.** **D2/955; D2/956**

(58) **Field of Classification Search** D2/902,
D2/906, 908, 916, 918, 925, 946-962, 977;
36/3 B, 22 R, 24.5, 25 R, 28, 32 R, 34 R,
36/59 C, 67 A, 103
See application file for complete search history.

(56) **References Cited**

U.S. PATENT DOCUMENTS

D39,747	S *	1/1909	McKenna	D2/955
1,120,082	A *	12/1914	Rhodes	36/25 A
1,552,022	A *	9/1925	Willson	36/59 C
2,365,027	A *	12/1944	Urbany	36/29
4,096,649	A *	6/1978	Saurwein	36/32 R
D259,595	S *	6/1981	Famolare, Jr.	D2/955
D267,366	S *	12/1982	Davis	D2/951
4,521,979	A *	6/1985	Blaser	36/29
4,571,852	A *	2/1986	Lamarche et al.	36/32 R
4,653,206	A *	3/1987	Tanel	36/126
D298,883	S *	12/1988	Tanel	D2/949
5,203,097	A *	4/1993	Blair	36/59 C
D394,939	S *	6/1998	Avar	D2/955
D395,157	S *	6/1998	von Conta	D2/955
D400,344	S *	11/1998	Avar	D2/954
D427,755	S *	7/2000	Tresser	D2/955
6,226,896	B1 *	5/2001	Friton	36/28
6,266,897	B1 *	7/2001	Seydel et al.	36/29
D461,040	S *	8/2002	Urie et al.	D2/955
D498,041	S *	11/2004	McClaskie	D2/956
D532,189	S *	11/2006	Truelsen	D2/956
D597,287	S *	8/2009	Vestuti et al.	D2/956
D601,783	S *	10/2009	Pizzuti	D2/908
D619,343	S *	7/2010	Vestuti et al.	D2/956
D627,545	S *	11/2010	Raysse	D2/947

7,921,580	B2 *	4/2011	Russell	36/28
D643,607	S *	8/2011	Teteriatnikov	D2/954
D644,008	S *	8/2011	Teteriatnikov	D2/954
D648,517	S *	11/2011	Vestuti et al.	D2/955
D655,489	S *	3/2012	Mahoney	D2/946
2003/0024134	A1 *	2/2003	Howlett et al.	36/43
2004/0123493	A1 *	7/2004	Russell	36/28
2006/0156580	A1 *	7/2006	Russell	36/28
2008/0263895	A1 *	10/2008	Russell	36/29
2010/0115791	A1 *	5/2010	Russell	36/28
2010/0139119	A1 *	6/2010	Sokolowski	36/8.3
2010/0146818	A1 *	6/2010	Sokolowski	36/102
2010/0251565	A1 *	10/2010	Litchfield et al.	36/28
2010/0325919	A1 *	12/2010	Elbaz et al.	36/103
2011/0072684	A1 *	3/2011	Stubblefield	36/29
2012/0005921	A1 *	1/2012	Diepenbrock	36/28
2012/0047770	A1 *	3/2012	Dean et al.	36/103

OTHER PUBLICATIONS

File History for U.S. Appl. No. 29/325,242 entitled Shoe Sole, filed Sep. 26, 2008.

File History for U.S. Appl. No. 29/339,457 entitled Shoe Sole, filed Jun. 30, 2009.

* cited by examiner

Primary Examiner — T. Chase Nelson

(74) *Attorney, Agent, or Firm* — Faegre Baker Daniels LLP

(57) **CLAIM**

The ornamental design for footwear sole, as shown and described.

DESCRIPTION

FIG. 1 is a front perspective view;

FIG. 2 is a front view;

FIG. 3 is a back view;

FIG. 4 is an inner side view;

FIG. 5 is an outer side view;

FIG. 6 is a top view; and,

FIG. 7 is a bottom view.

The broken line showing of the upper is for illustrative purpose only and forms no part of the claimed design.

1 Claim, 7 Drawing Sheets

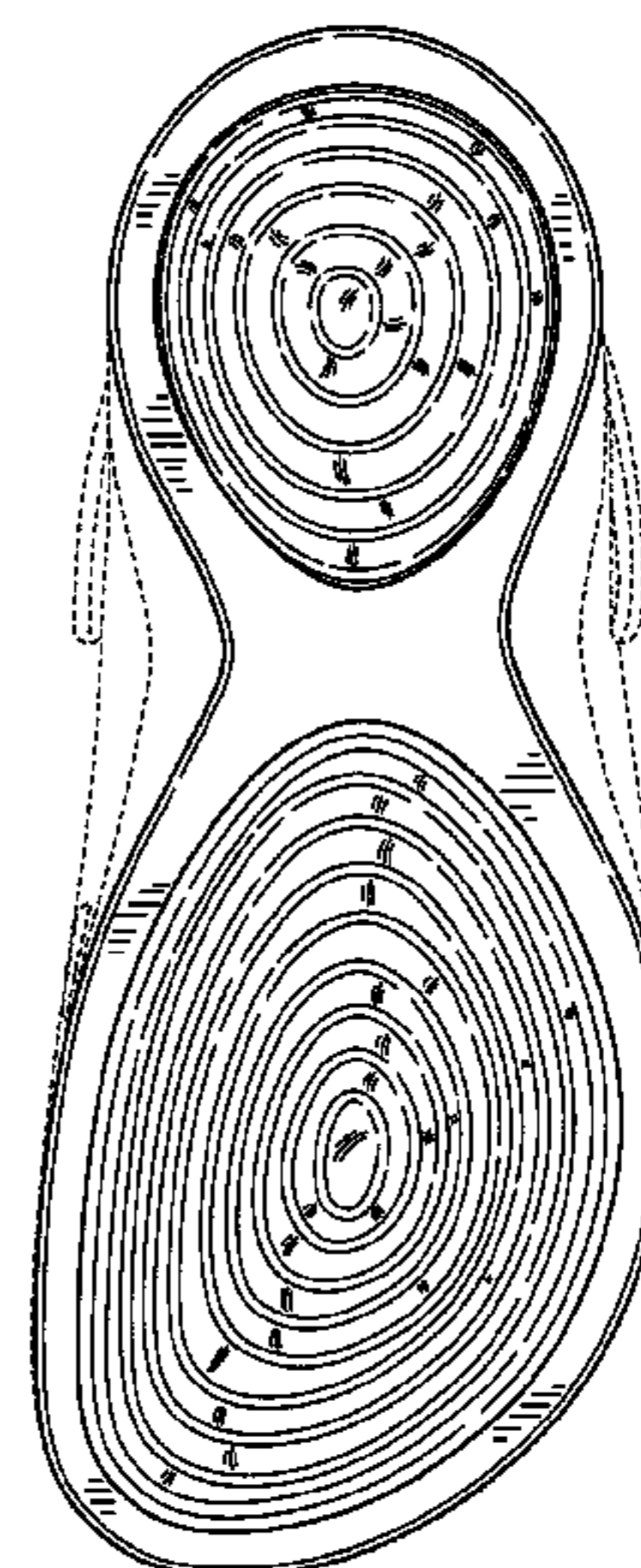
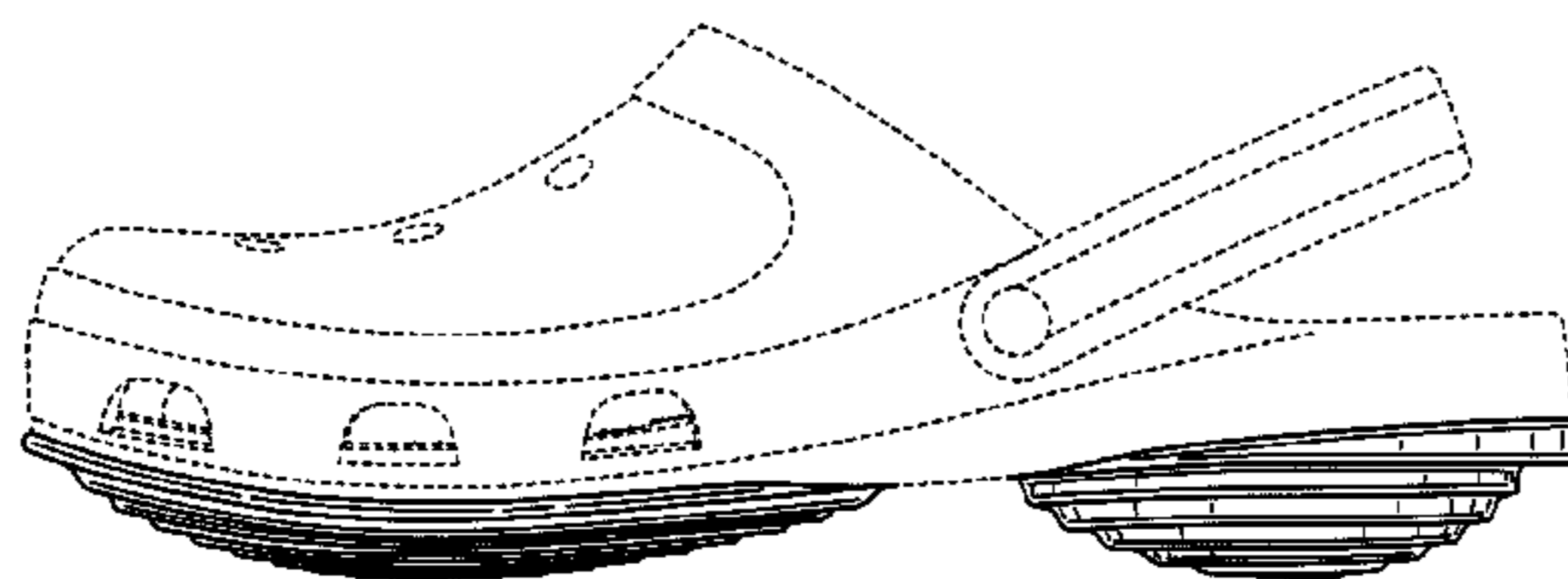

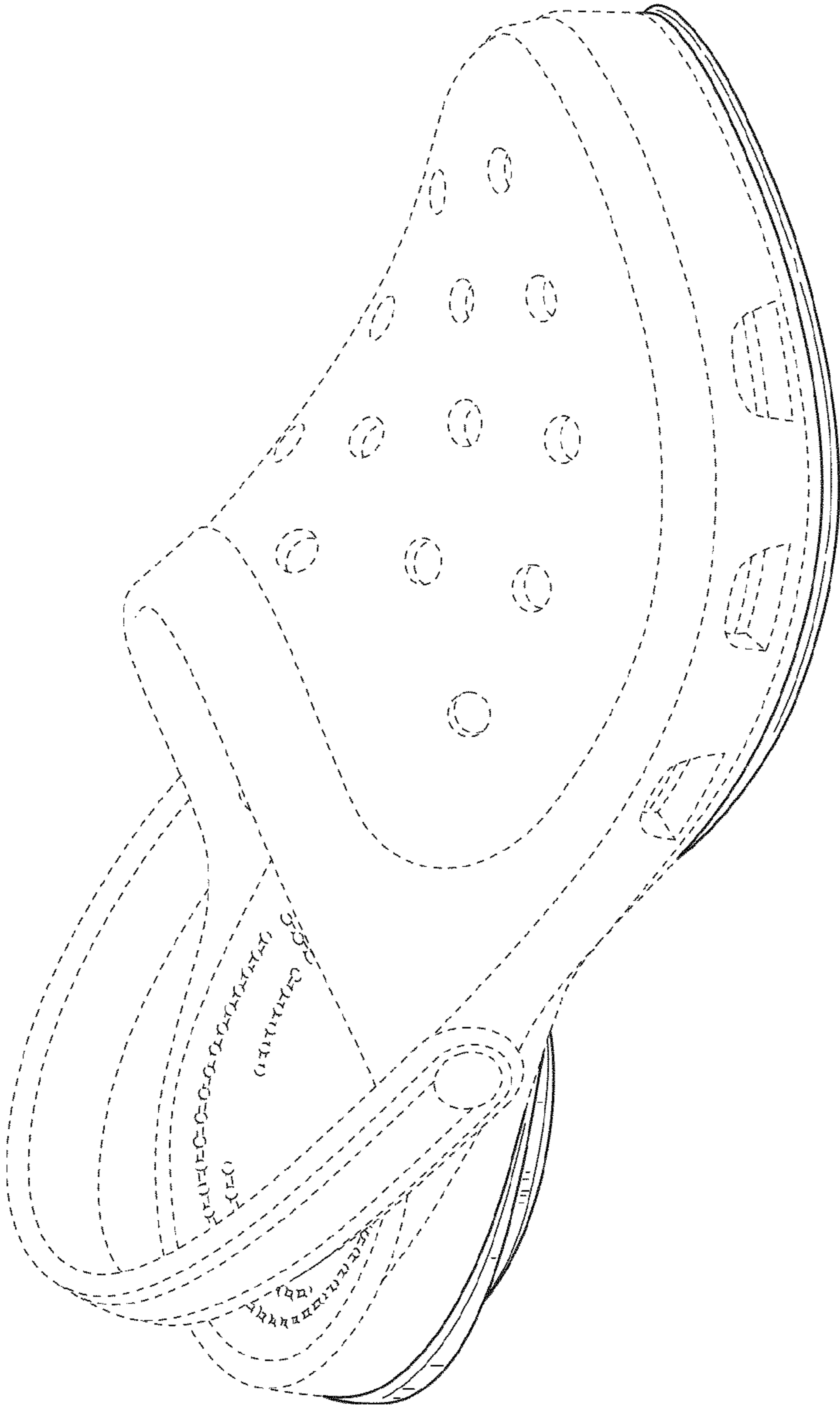

FIG.1

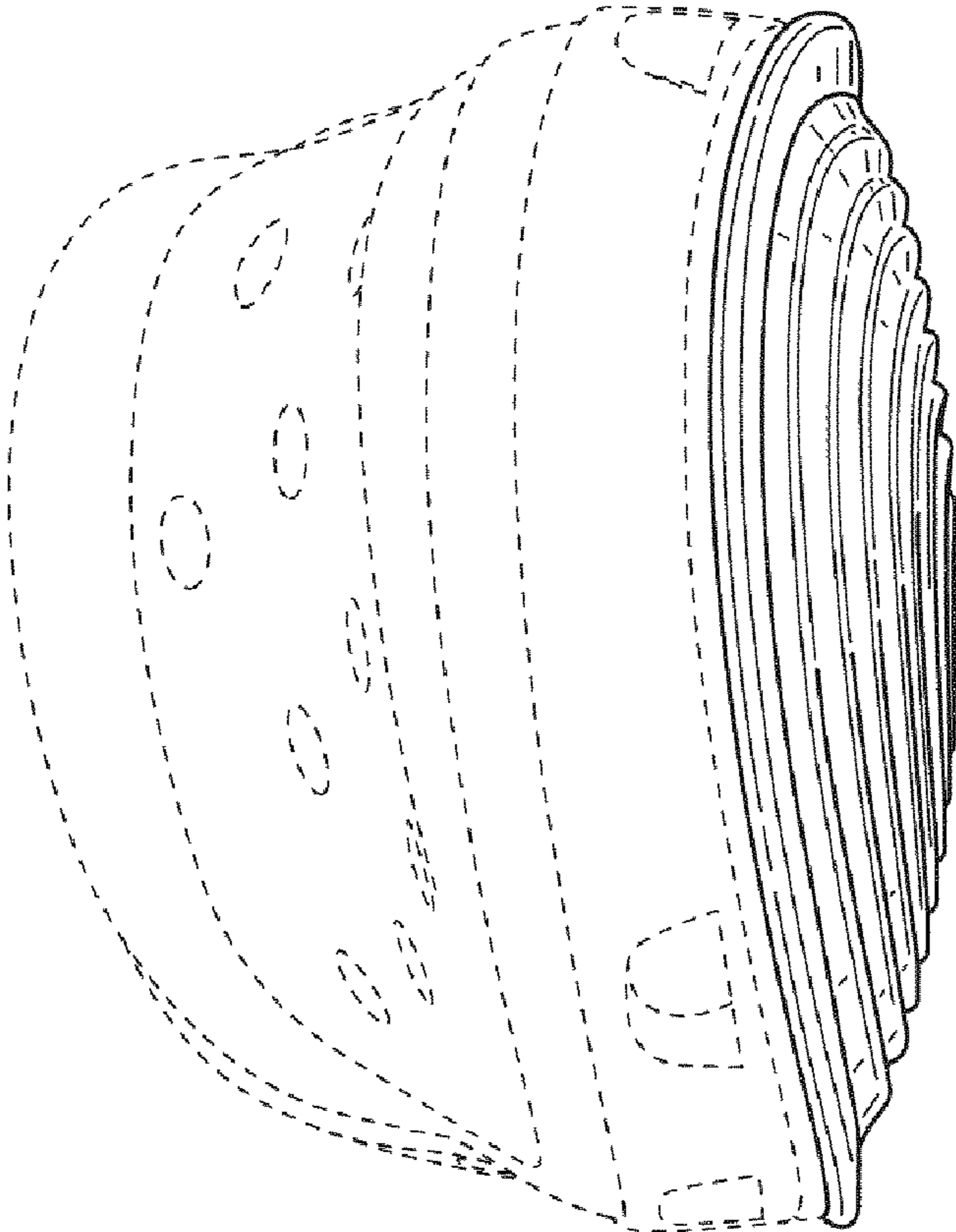

FIG.2

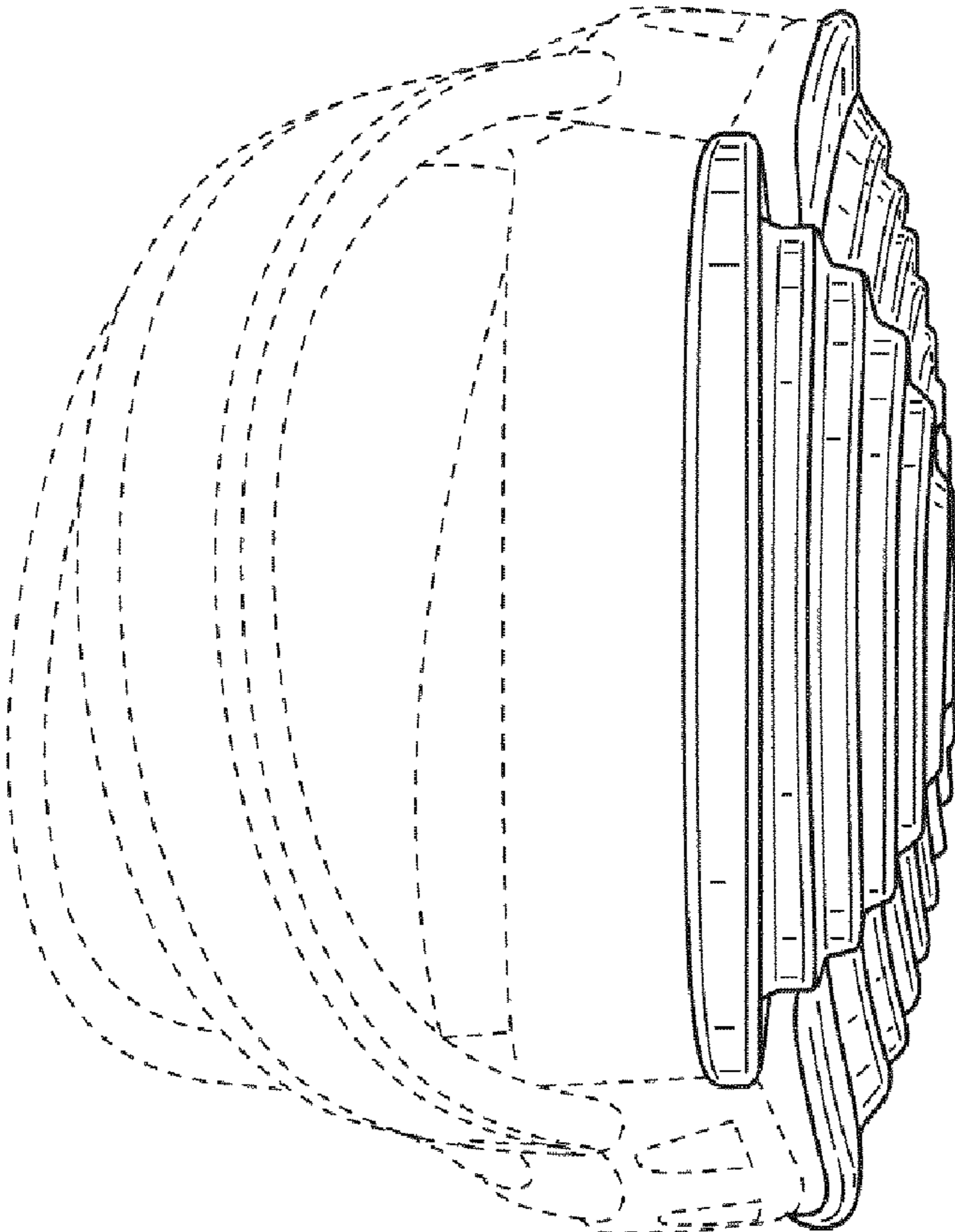

FIG.3

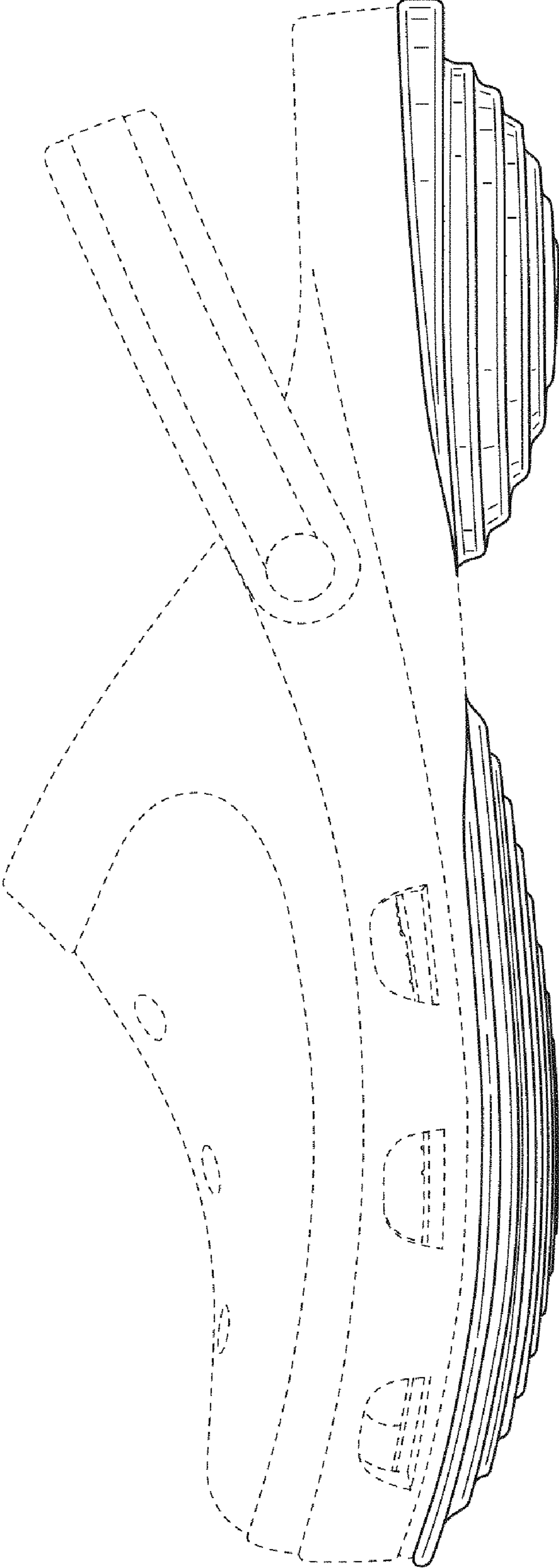

FIG.4

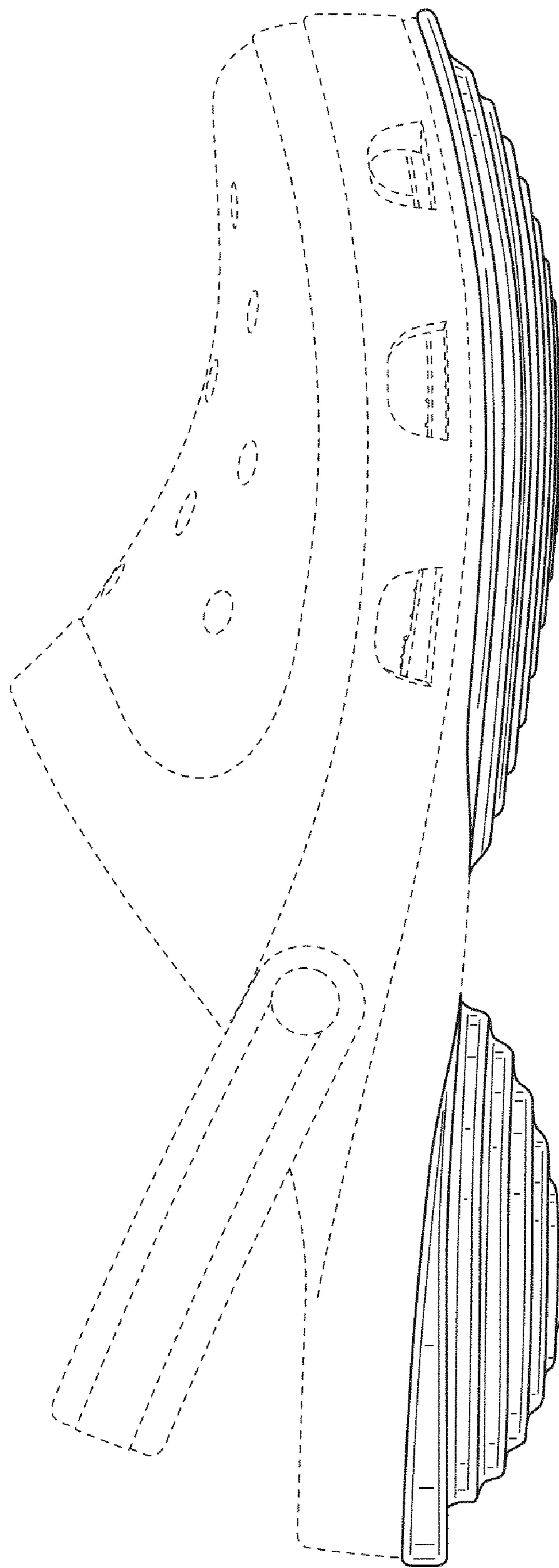

FIG. 5

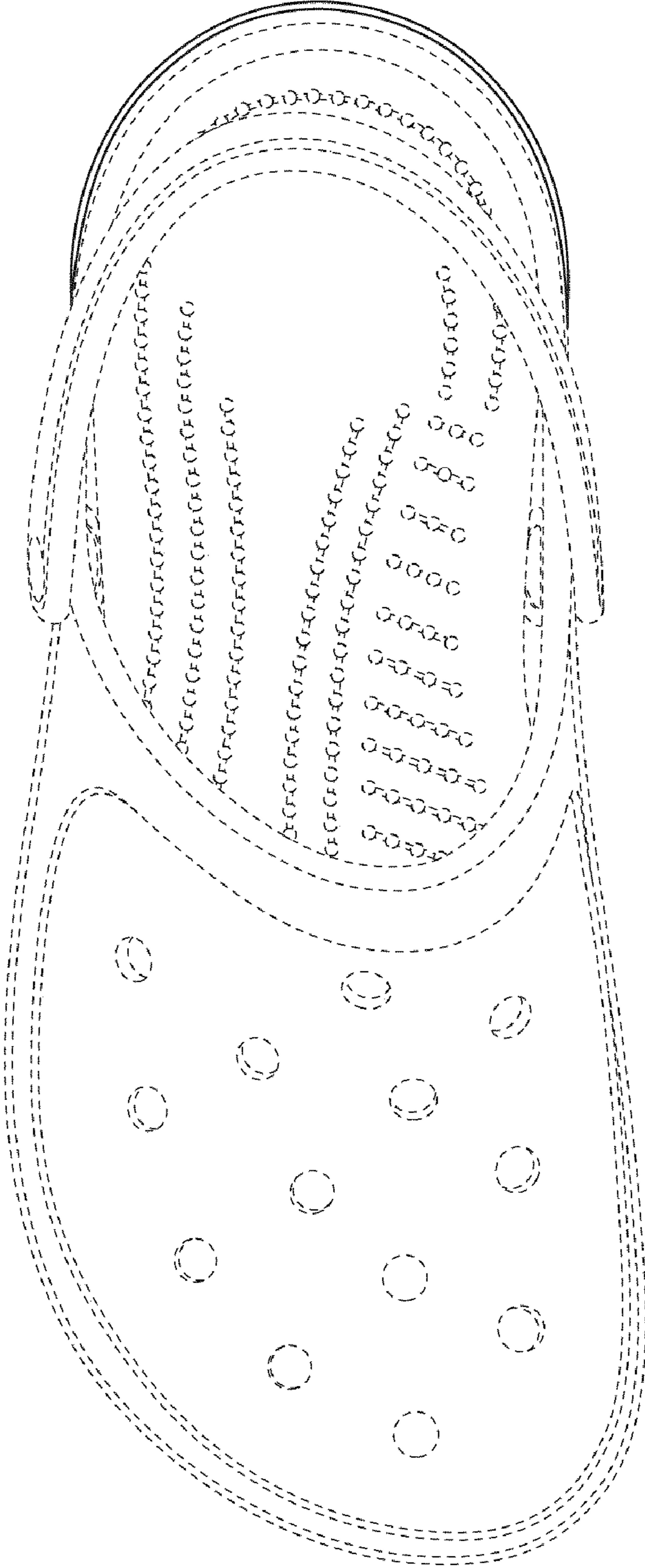

FIG.6

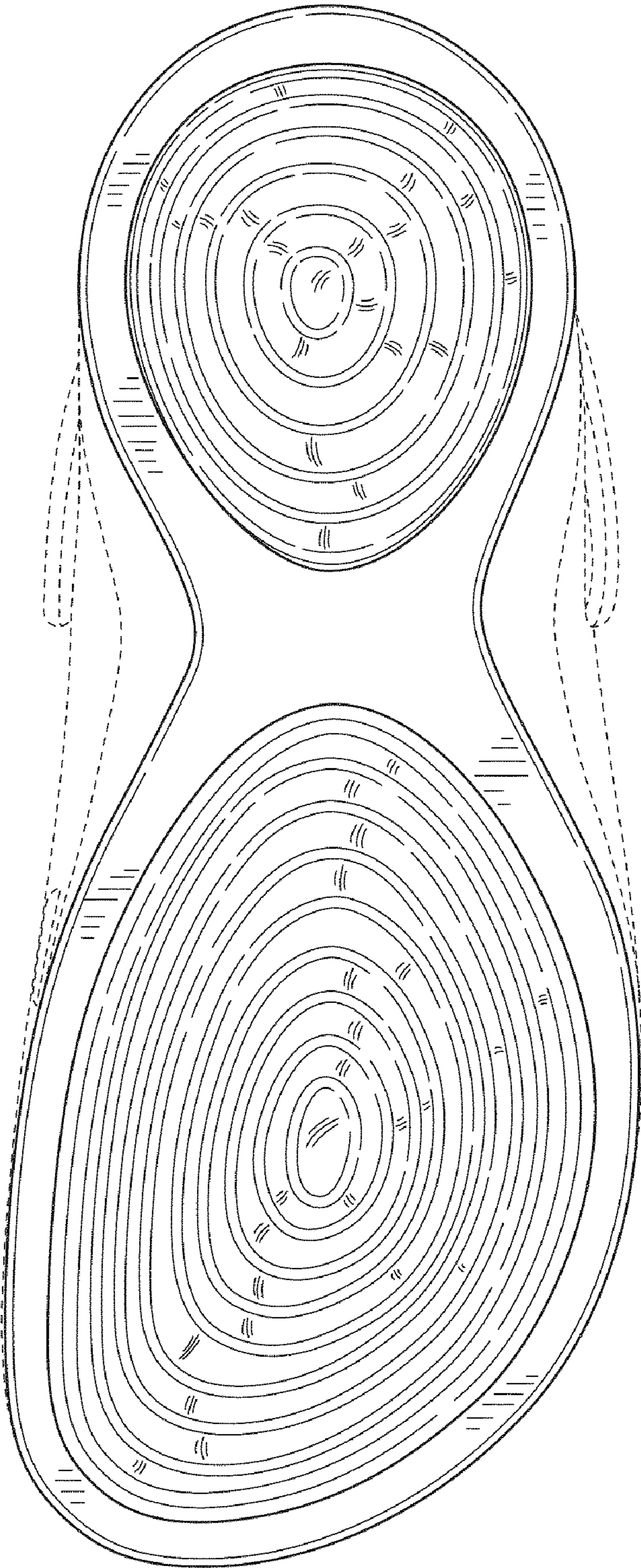

FIG.7