



US00D664664S

(12) **United States Design Patent**  
**Mai**

(10) **Patent No.:** **US D664,664 S**  
(45) **Date of Patent:** **\*\* Jul. 31, 2012**

(54) **PEDICURE FOOT SPA**

(76) Inventor: **Theresa Mai**, Sugar Land, TX (US)

(\*\*) Term: **14 Years**

(21) Appl. No.: **29/396,242**

(22) Filed: **Jun. 28, 2011**

(51) **LOC (9) CI.** ..... **23-02**

(52) **U.S. CI.** ..... **D24/204**

(58) **Field of Classification Search** ..... D24/200–205,  
D24/212, 213; D28/56, 61; D6/336, 495;  
601/6, 15, 64, 157–158, 30–32; 607/44;  
4/622, 574.1

See application file for complete search history.

(56) **References Cited**

U.S. PATENT DOCUMENTS

D457,018 S *	5/2002	Park	.....	D6/495
D560,310 S *	1/2008	Le	.....	D28/56
D564,099 S *	3/2008	Ton	.....	D24/204
D571,018 S *	6/2008	Ton et al.	.....	D24/204
D588,707 S *	3/2009	Mai et al.	.....	D24/213
D600,815 S *	9/2009	Ton	.....	D24/204

D608,898 S *	1/2010	Ton	.....	D24/204
D616,560 S *	5/2010	Cong	.....	D24/204
D618,815 S *	6/2010	Dang	.....	D24/204
D622,858 S *	8/2010	Jan	.....	D24/204
D635,786 S *	4/2011	Ton	.....	D6/336
D640,387 S *	6/2011	Tran	.....	D24/204
D641,485 S *	7/2011	Mai	.....	D24/204

\* cited by examiner

*Primary Examiner* — David Muller

(74) *Attorney, Agent, or Firm* — Cherskov Flaynik & Gurda, LLC

(57) **CLAIM**

The ornamental design for a pedicure foot spa, as shown and described.

**DESCRIPTION**

FIG. 1 is a front-right perspective of applicant's design.  
FIG. 2 is a front elevational view thereof;  
FIG. 3 is a rear elevational view thereof;  
FIG. 4 is a left side elevational view thereof;  
FIG. 5 is a right side elevational view thereof;  
FIG. 6 is a top plan view thereof; and,  
FIG. 7 is a bottom plan view thereof.

**1 Claim, 4 Drawing Sheets**

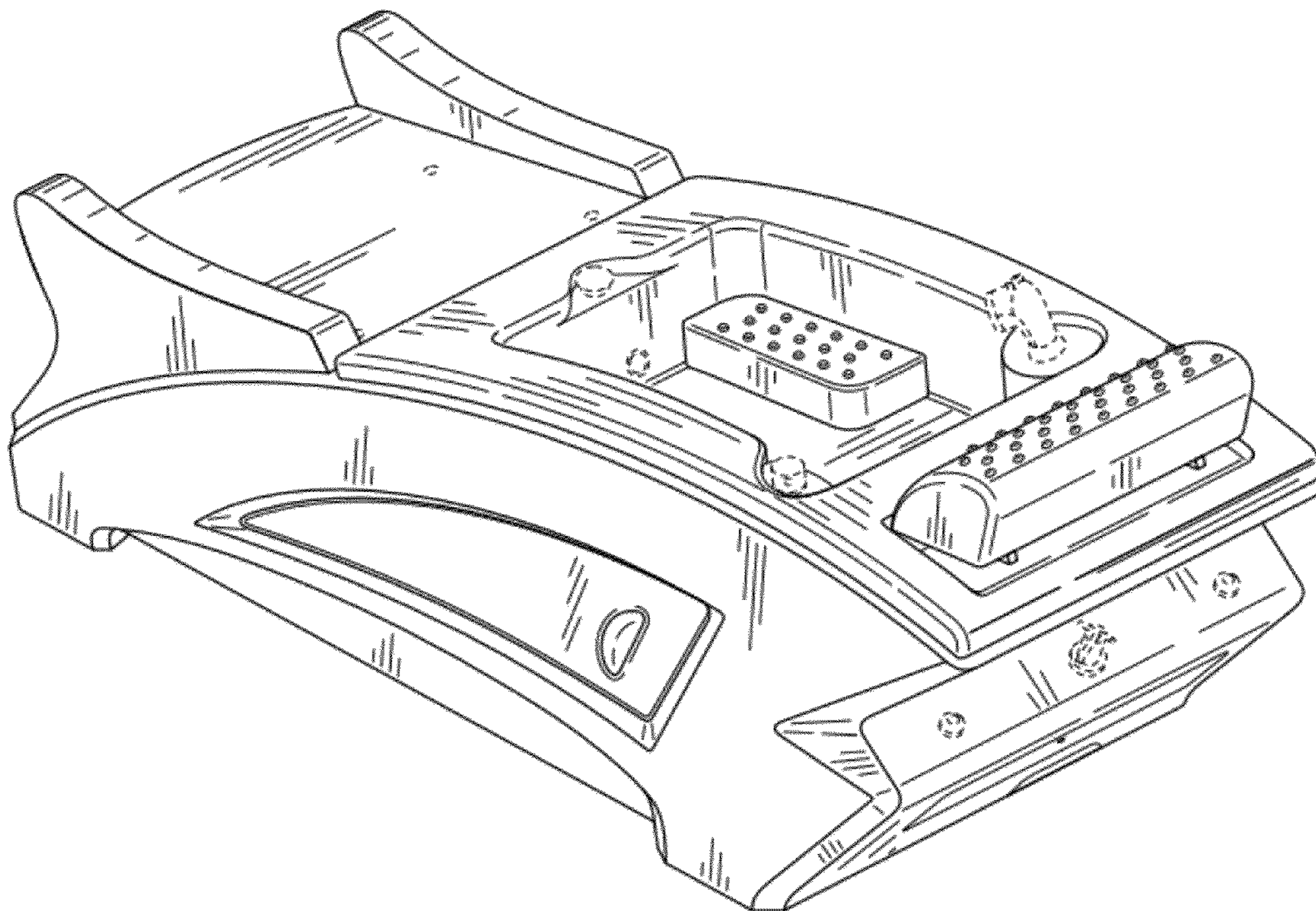



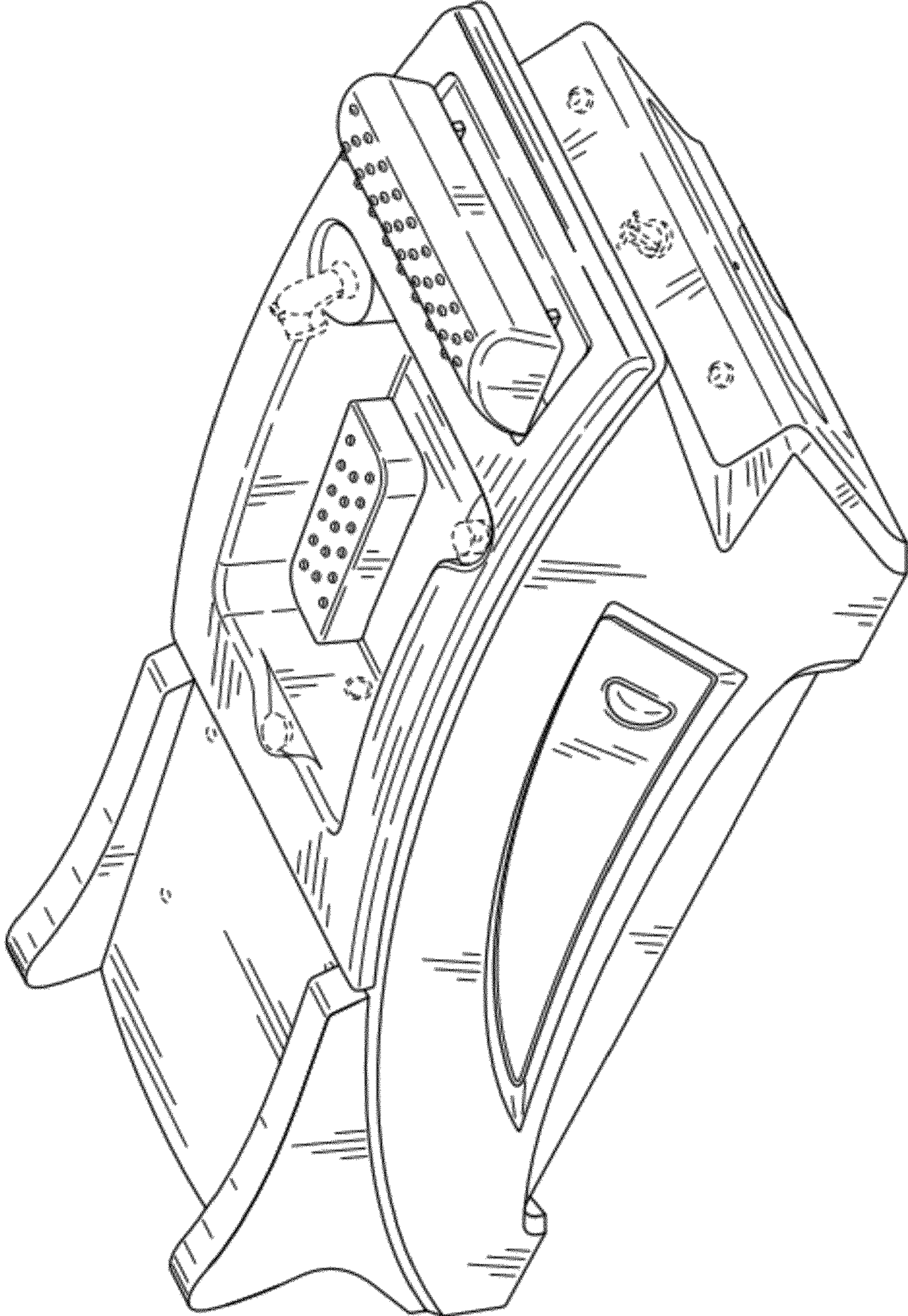

FIG. 1



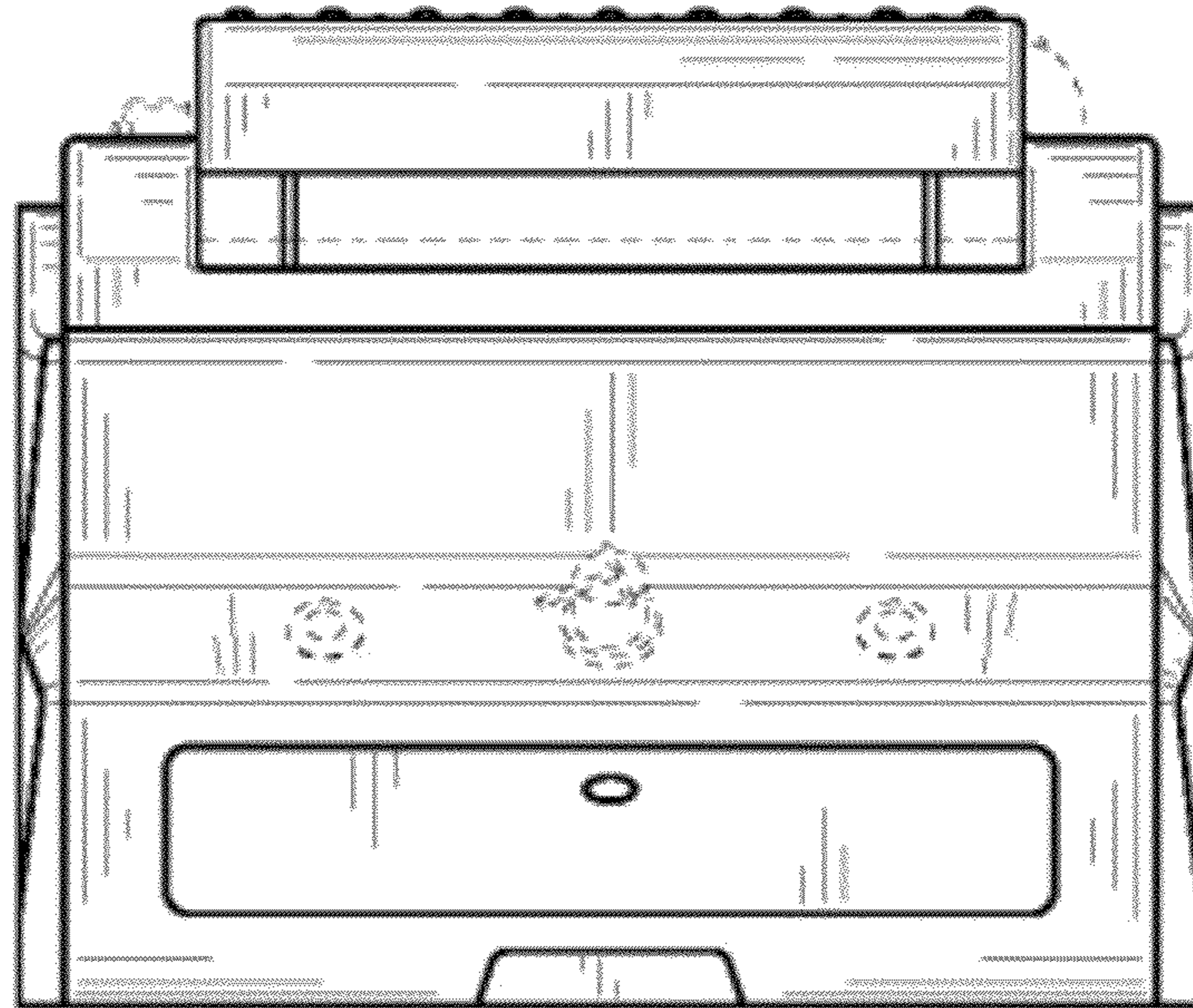

FIG. 2

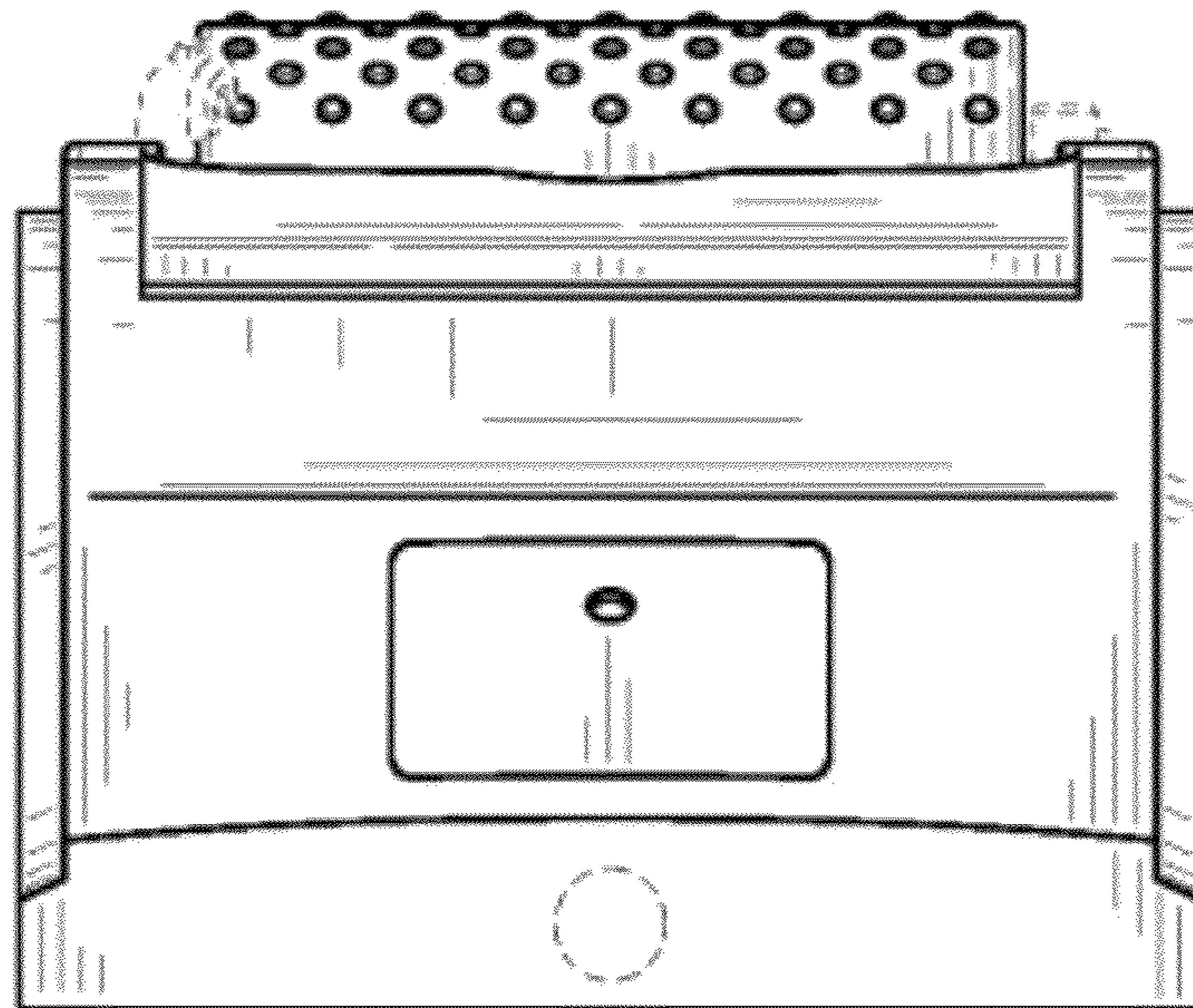

FIG. 3

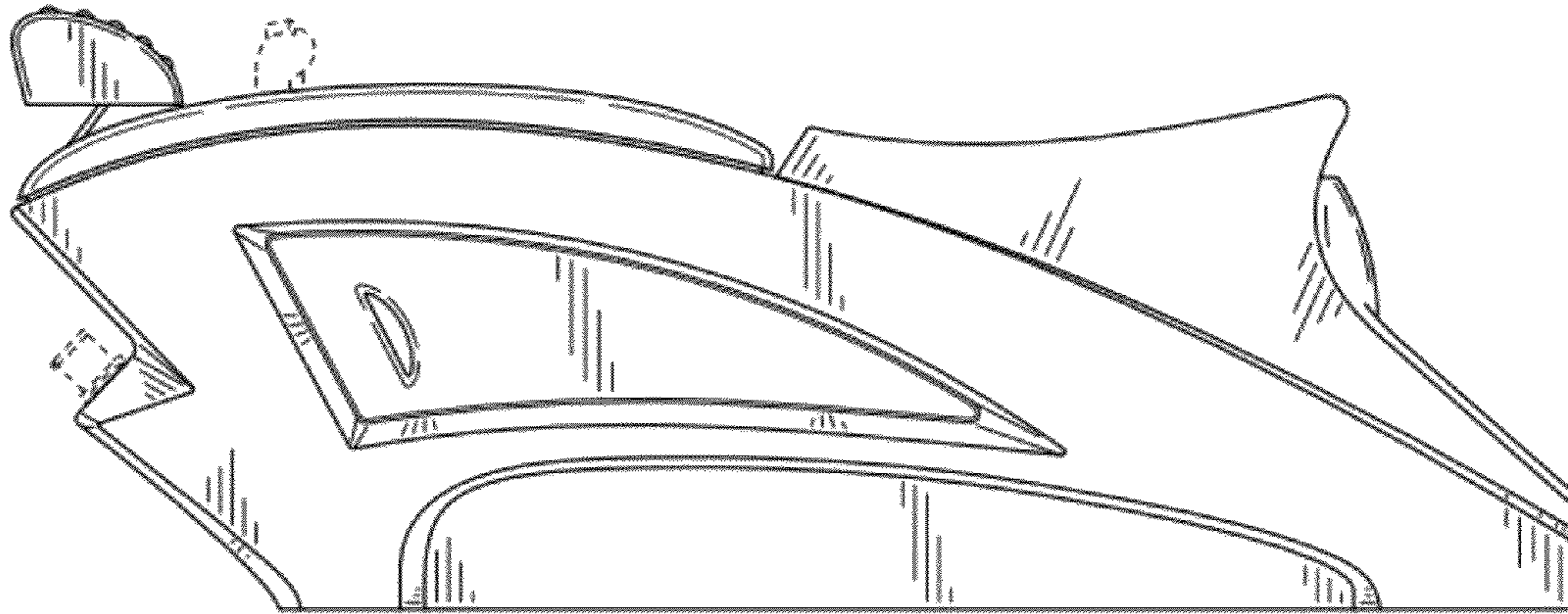

FIG. 4

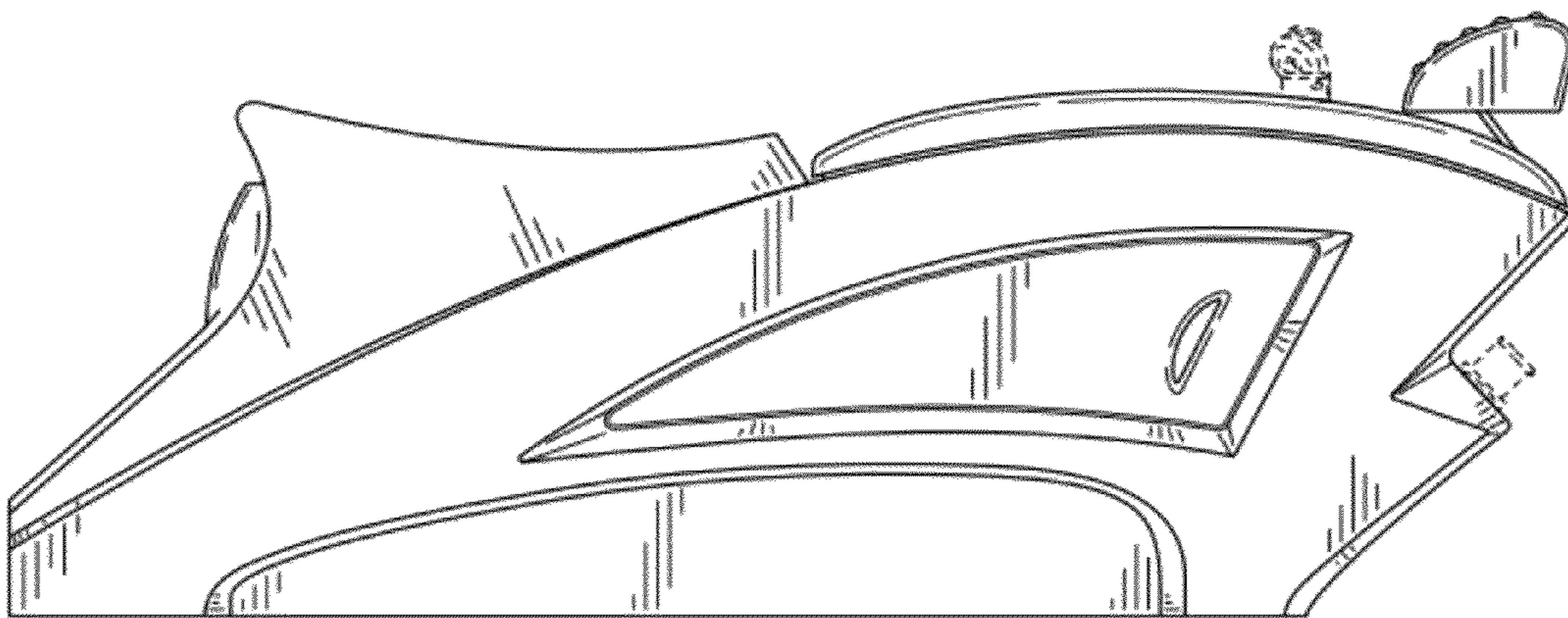

FIG. 5



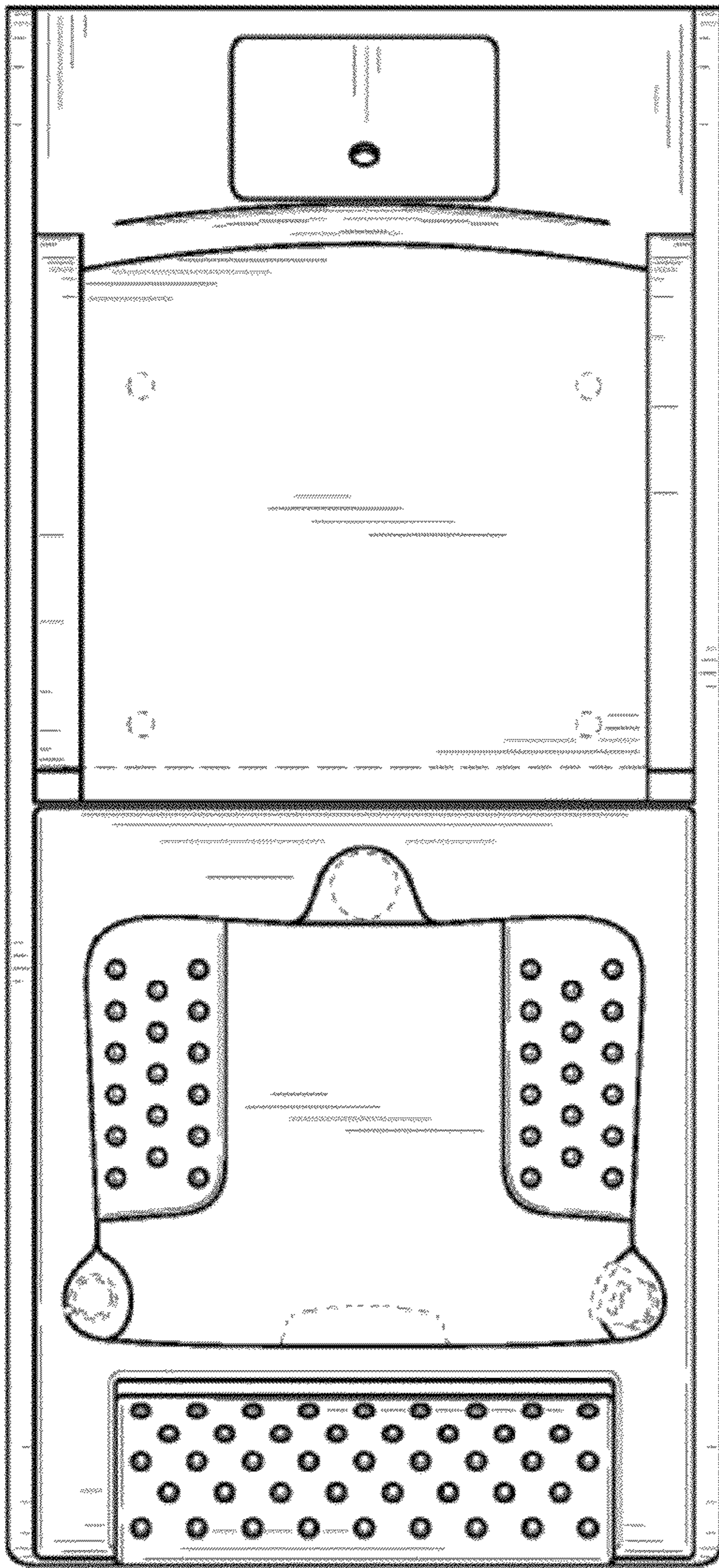

FIG. 6

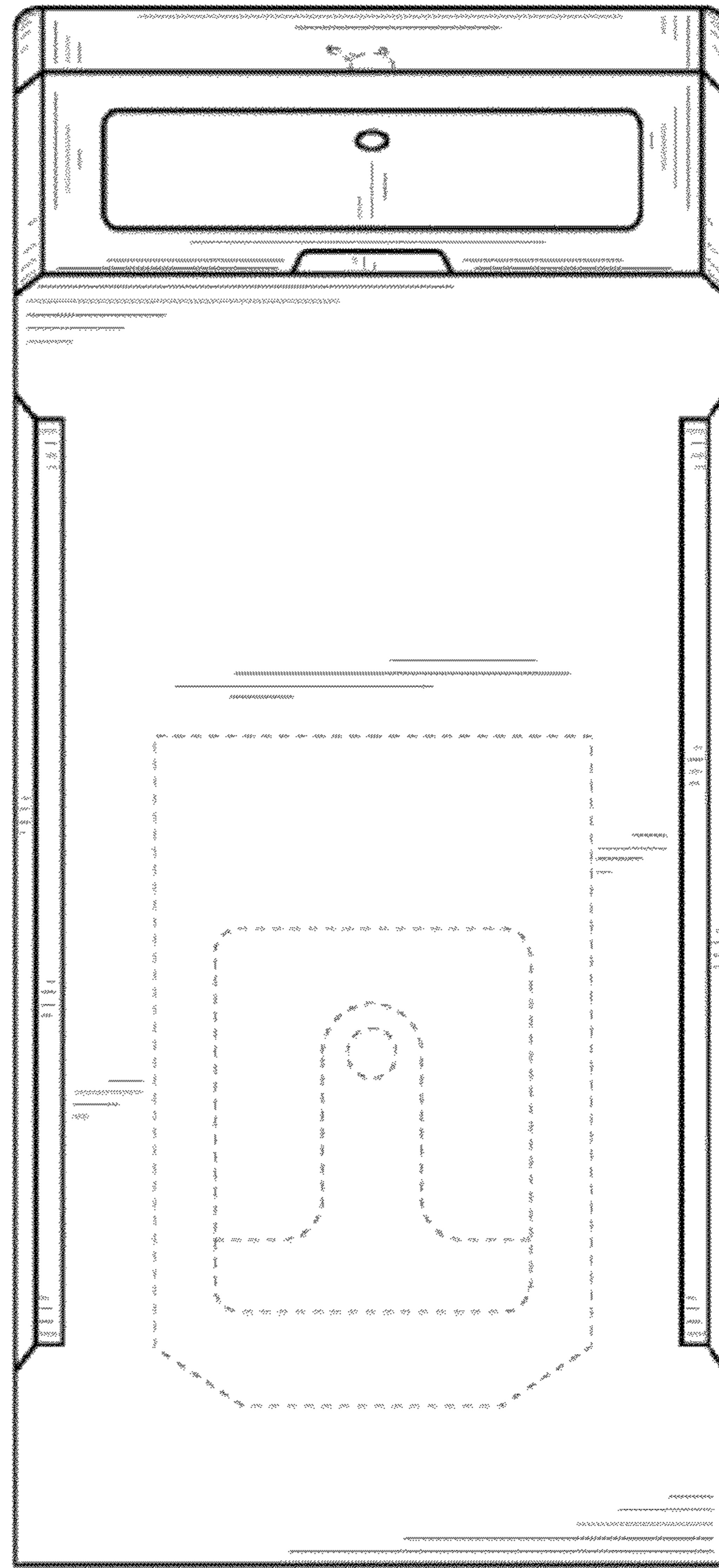

FIG. 7