



US00D664602S

(12) **United States Design Patent**
Chiu et al.

(10) **Patent No.:** **US D664,602 S**

(45) **Date of Patent:** **** Jul. 31, 2012**

(54) **GAMING CRADLE FOR PAD**

(75) Inventors: **Wen-Yi Chiu**, Taipei (TW); **Hsin Yeh**, Taipei (TW); **Wei-Chih Hsu**, Taipei (TW); **Yung-Hsiang Chen**, Taipei (TW)

(73) Assignee: **Compal Electronics, Inc.**, Taipei (TW)

(**) Term: **14 Years**

(21) Appl. No.: **29/393,176**

(22) Filed: **May 31, 2011**

(51) **LOC (9) Cl.** **21-01**

(52) **U.S. Cl.** **D21/333; D14/496; D14/432**

(58) **Field of Classification Search** D21/324, D21/328, 332, 333; D14/496, 432, 433, D14/439, 440, 217, 224; D12/191; 273/148 B; 463/1, 46, 47; 345/156; 359/601, 604, 609, 359/612; 296/97.1, 1.07; 348/834, 836, 348/838, 842; 224/929; 206/701

See application file for complete search history.

(56) **References Cited**

U.S. PATENT DOCUMENTS

4,444,465	A *	4/1984	Giulie et al.	359/601
5,905,546	A *	5/1999	Giulie et al.	348/842
6,065,841	A *	5/2000	Heller et al.	359/609
D432,586	S *	10/2000	Galli-Zugaro et al.	D21/333
6,302,546	B1 *	10/2001	Kordiak	359/608
D452,247	S *	12/2001	Flynn	D14/454
6,932,341	B1 *	8/2005	Kenyon	273/148 B
7,134,758	B1 *	11/2006	Baker	359/601
D534,962	S *	1/2007	Svensen et al.	D21/333
D589,962	S *	4/2009	Maruyama et al.	D14/432

D628,242	S *	11/2010	Crowder	D21/333
D637,236	S *	5/2011	Lum et al.	D21/333
D645,865	S *	9/2011	Diehl	D14/432

* cited by examiner

Primary Examiner — Prabhakar Deshmukh

(74) *Attorney, Agent, or Firm* — Muncy, Geissler, Olds & Lowe, PLLC

(57) **CLAIM**

The ornamental design for a gaming cradle for pad, as shown and described.

DESCRIPTION

FIG. 1 is a perspective view of a gaming cradle for pad showing our new design;
 FIG. 2 is a front view thereof;
 FIG. 3 is a rear view thereof;
 FIG. 4 is a left side view thereof;
 FIG. 5 is a right side view thereof;
 FIG. 6 is a top view thereof;
 FIG. 7 is a bottom view thereof;
 FIG. 8 is a perspective view of a gaming cradle for pad showing our new design in use;
 FIG. 9 is a front view thereof;
 FIG. 10 is a rear view thereof;
 FIG. 11 is a left side view thereof;
 FIG. 12 is a right side view thereof;
 FIG. 13 is a top view thereof; and,
 FIG. 14 is a bottom view thereof.

The broken line showing of the pad is for the purpose of illustrating environmental structure and forms no part of the claimed design.

1 Claim, 8 Drawing Sheets

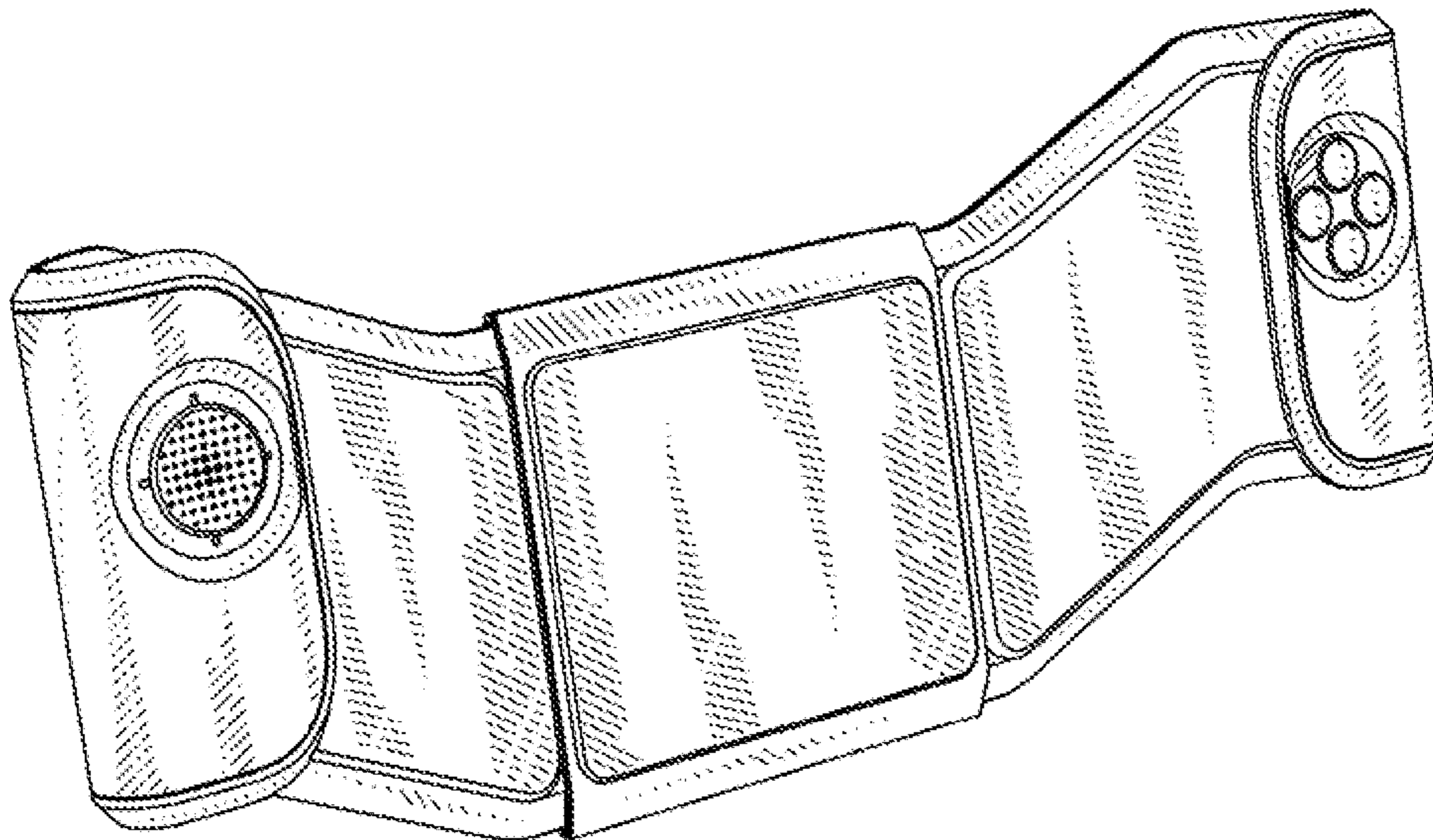

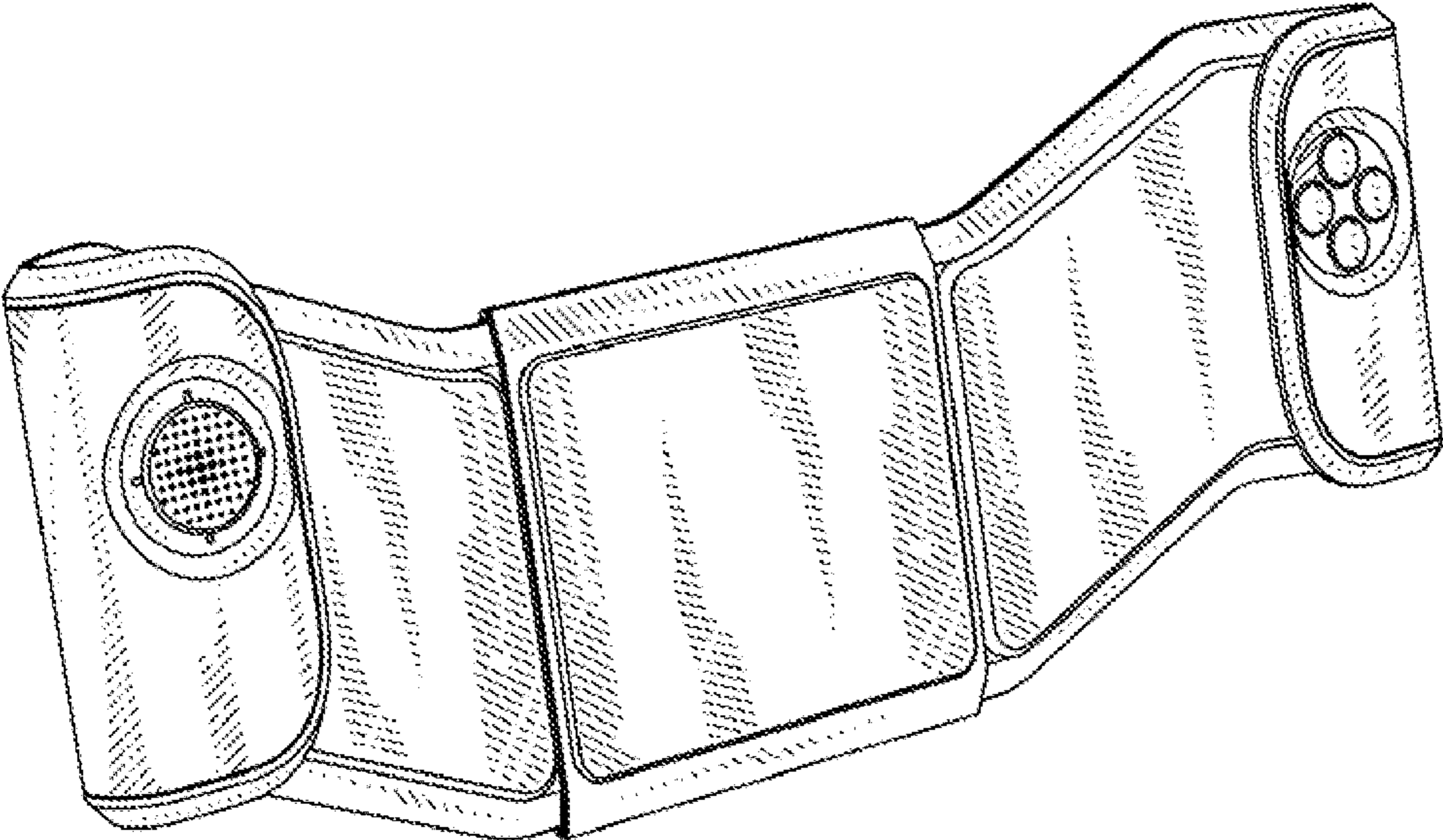

Fig. 1

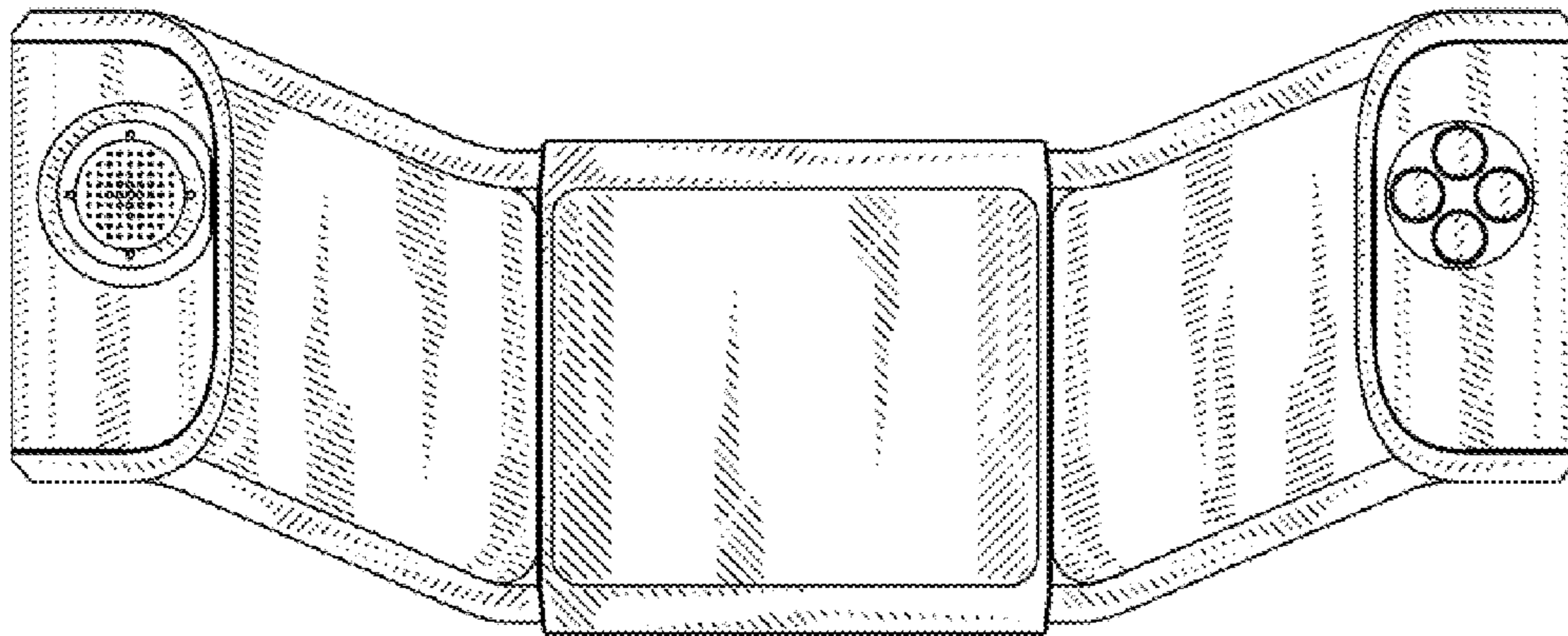

Fig. 2

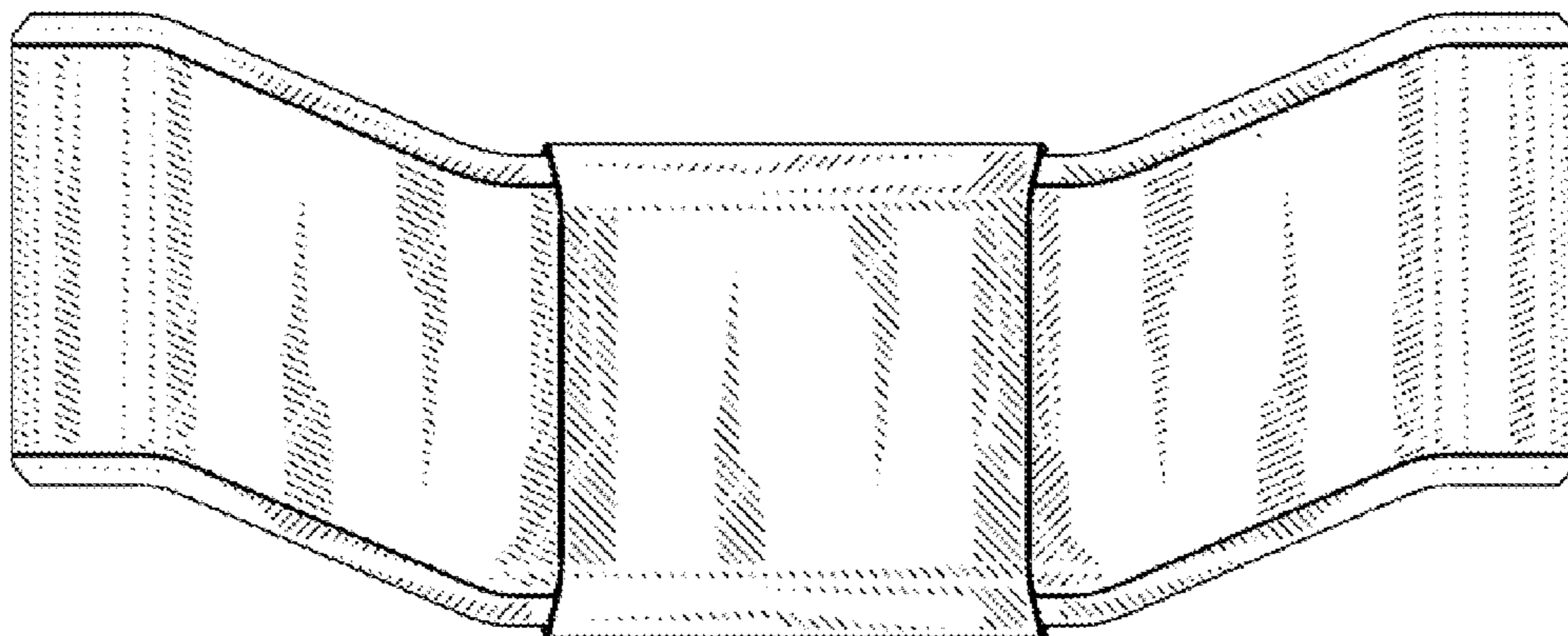

Fig. 3

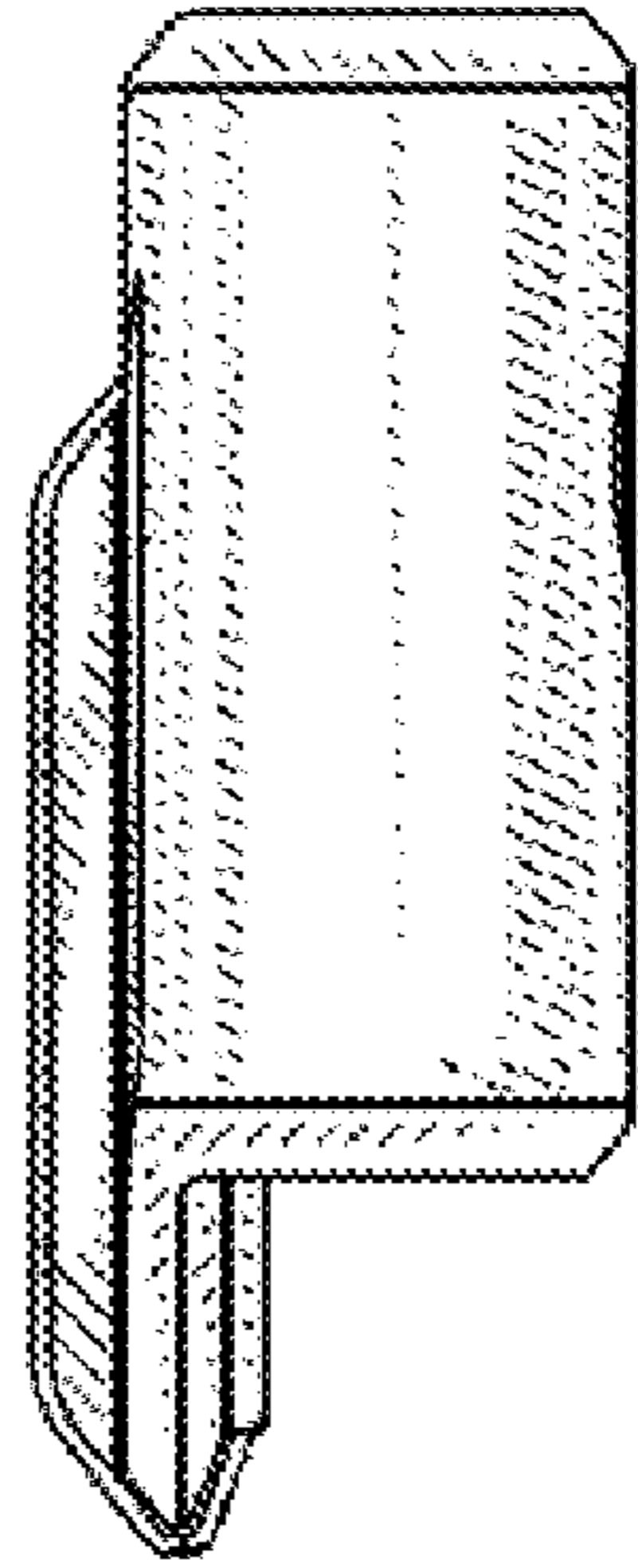

Fig. 4

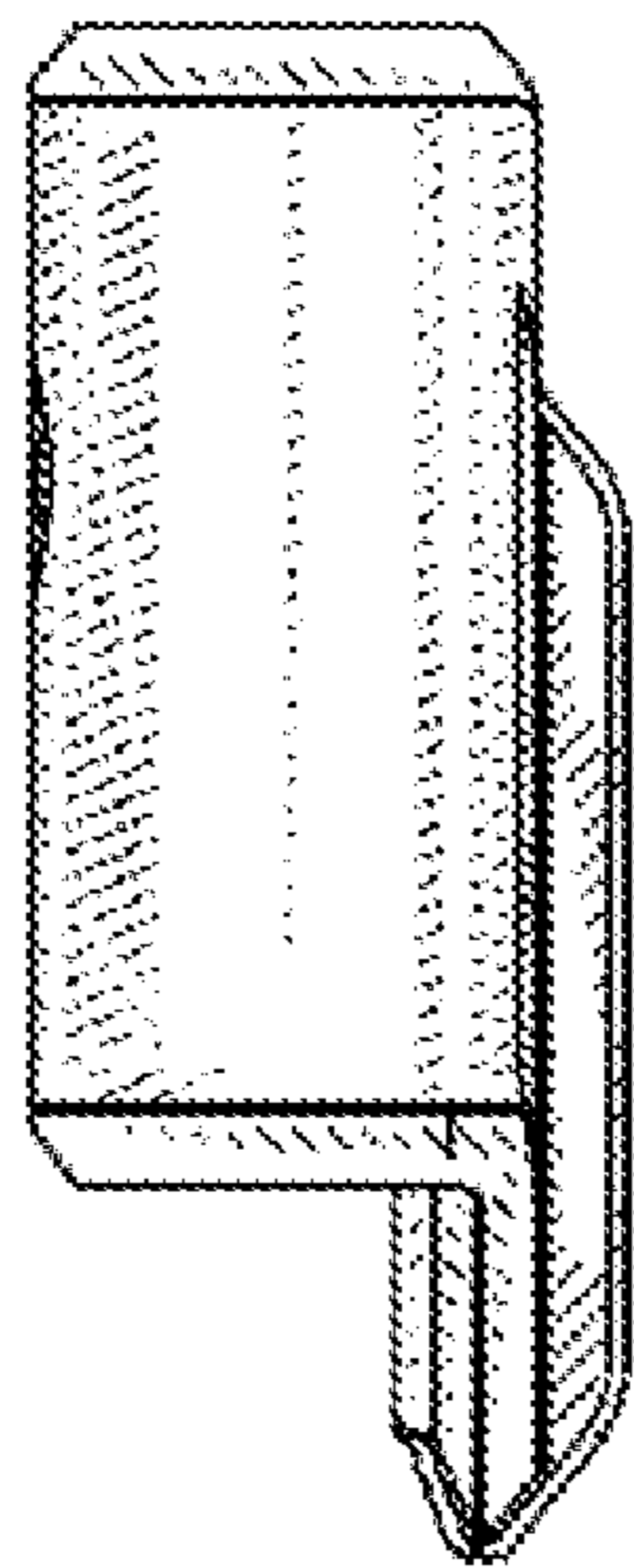

Fig. 5

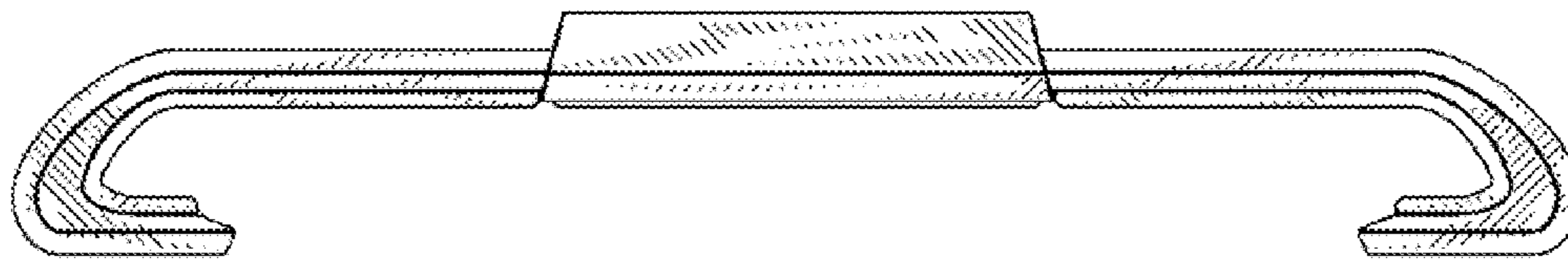

Fig. 6

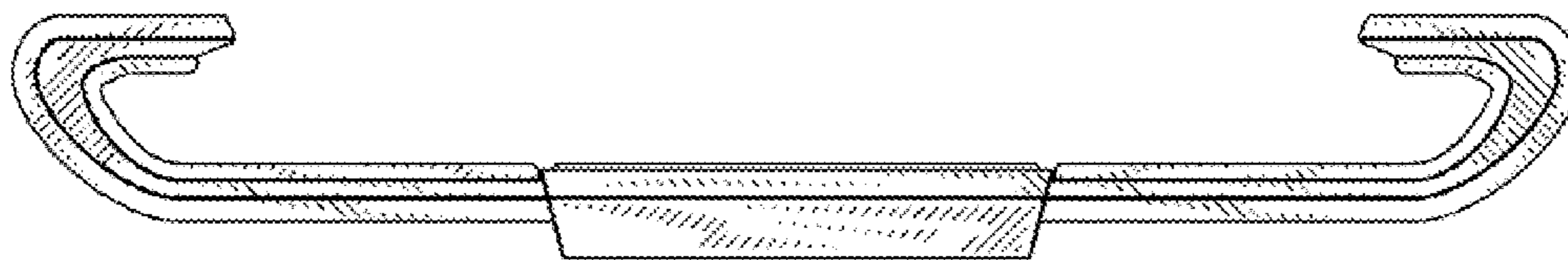

Fig. 7

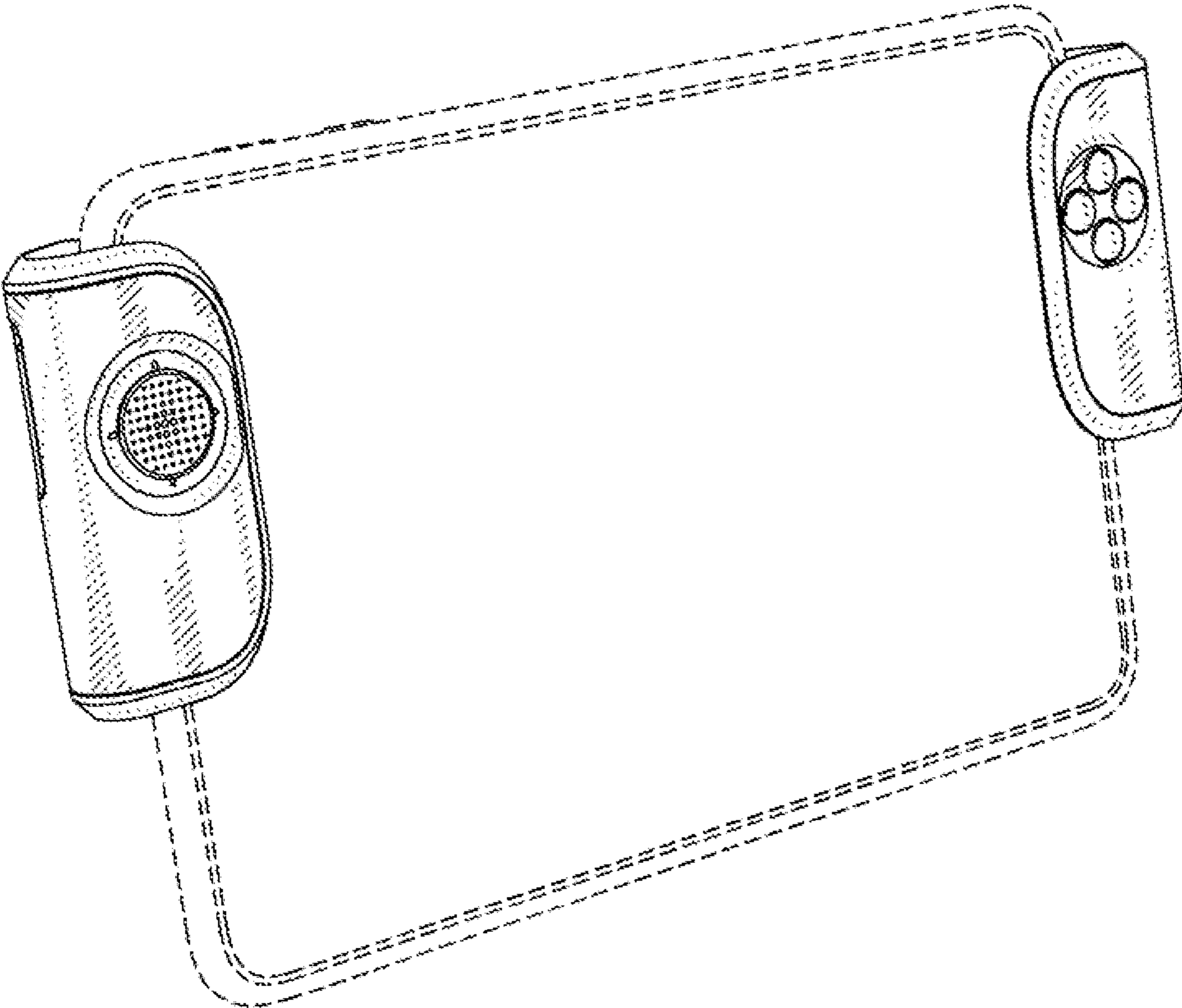

Fig. 8

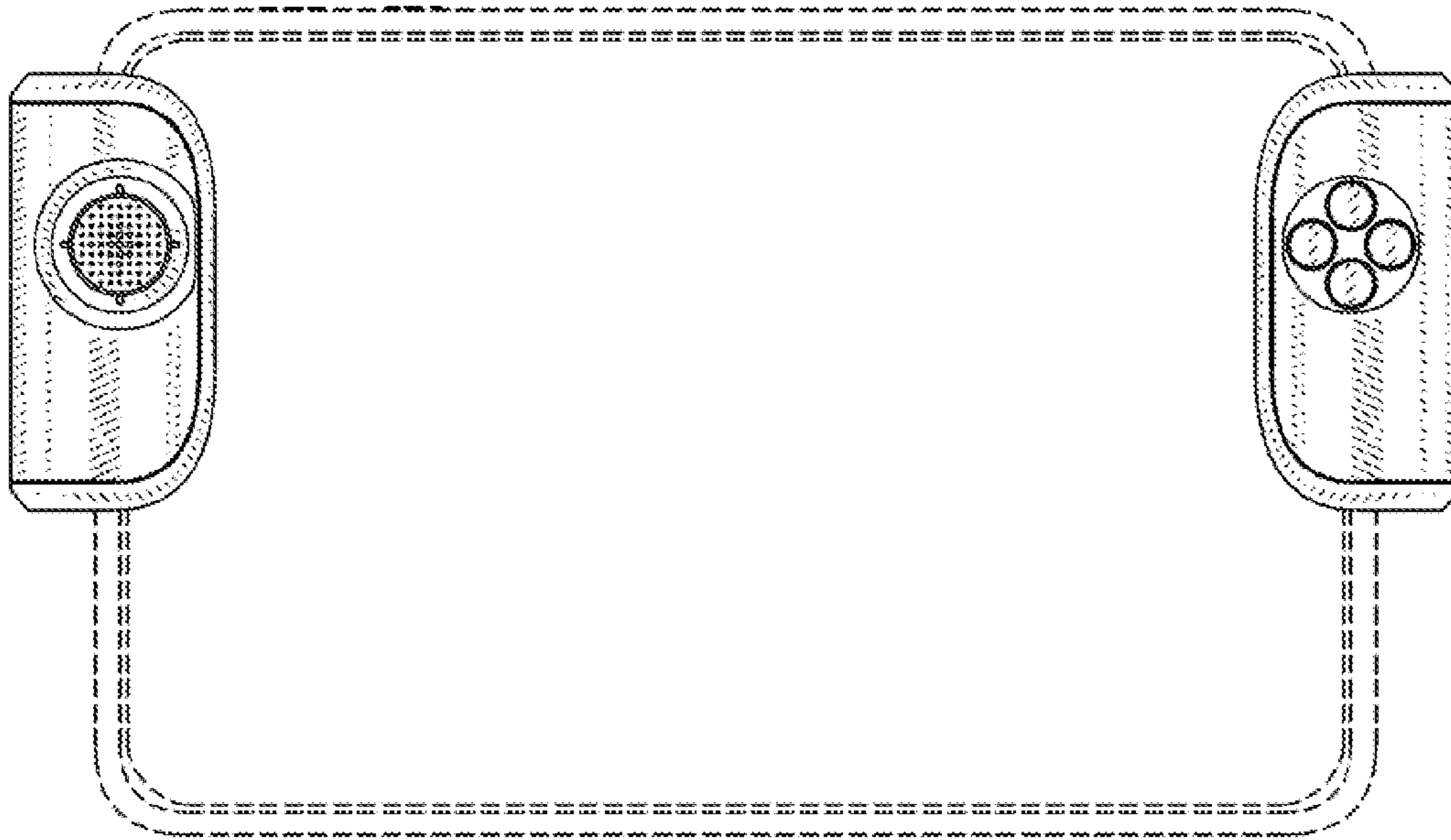

Fig. 9

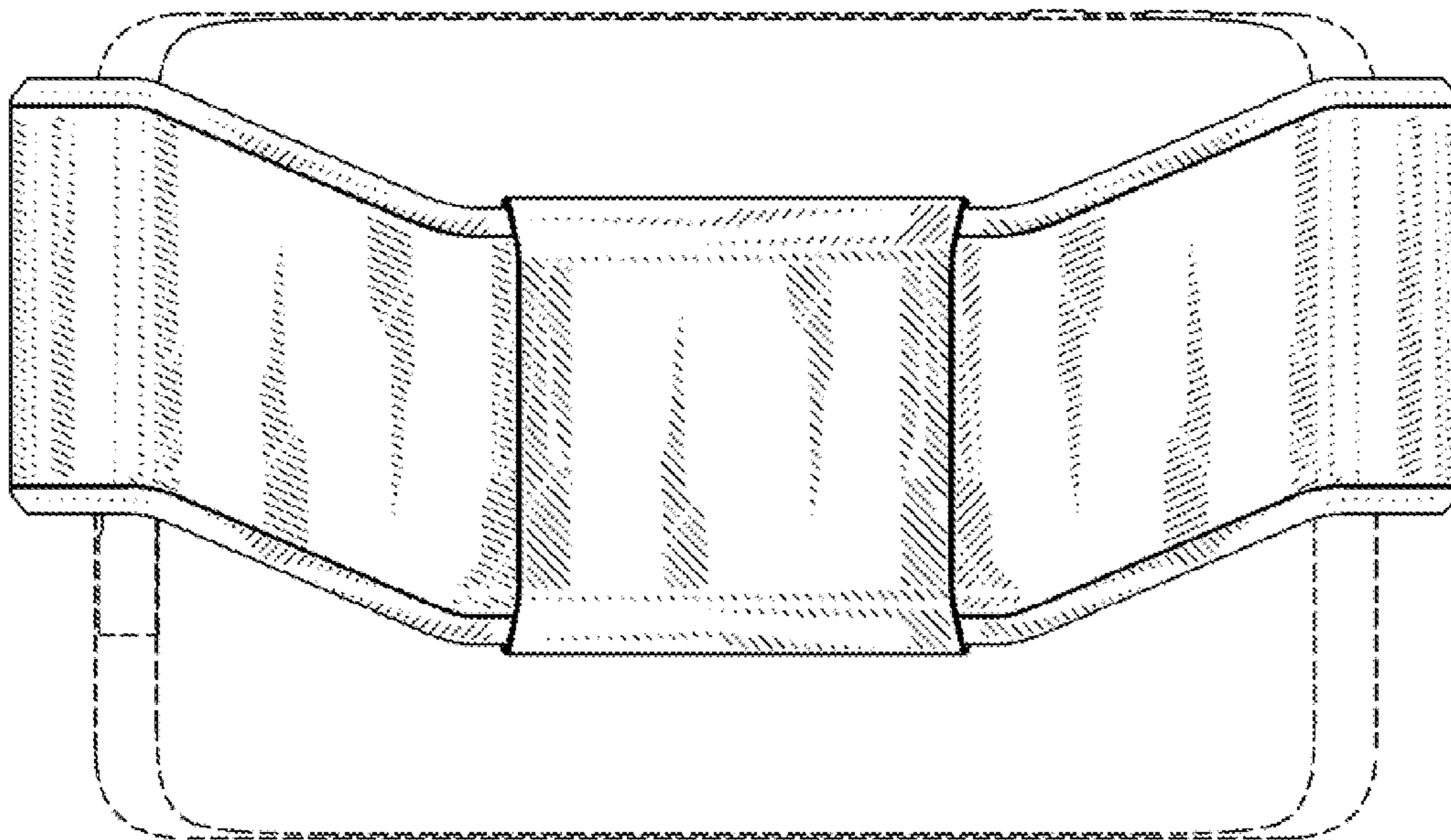

Fig. 10

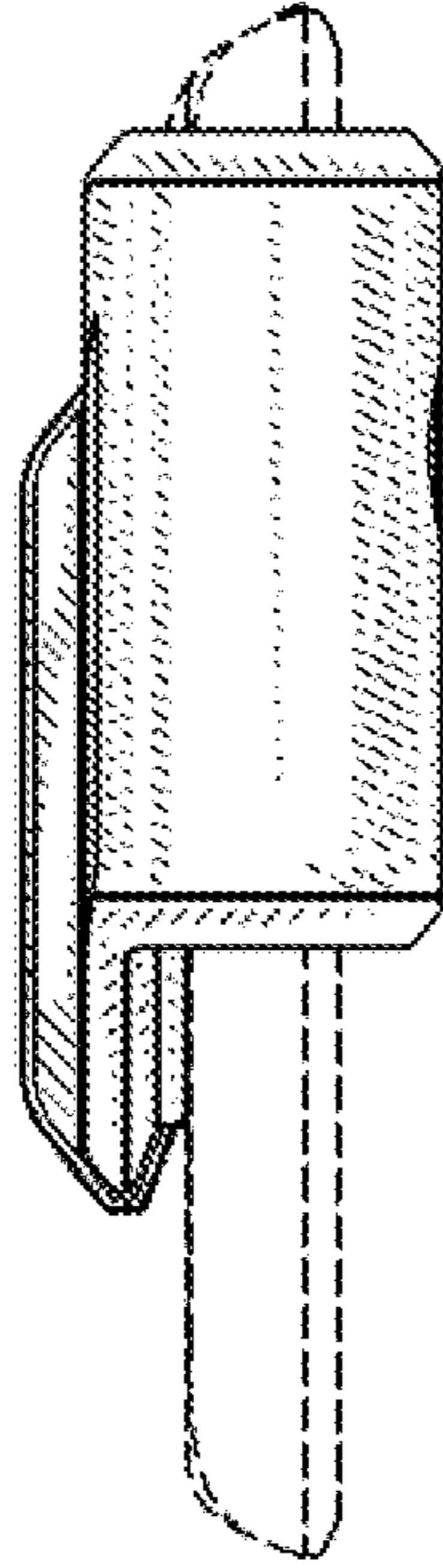

Fig. 11

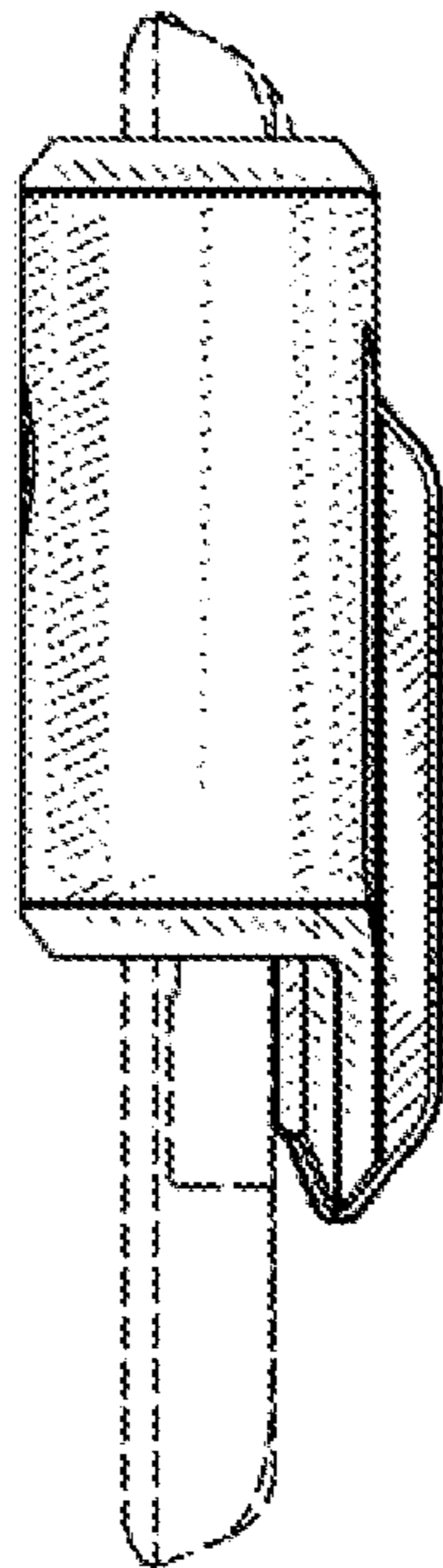

Fig. 12

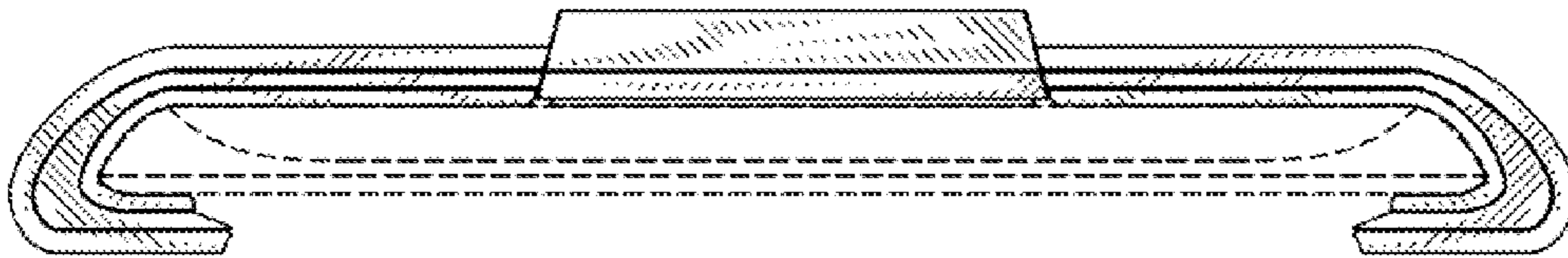

Fig. 13

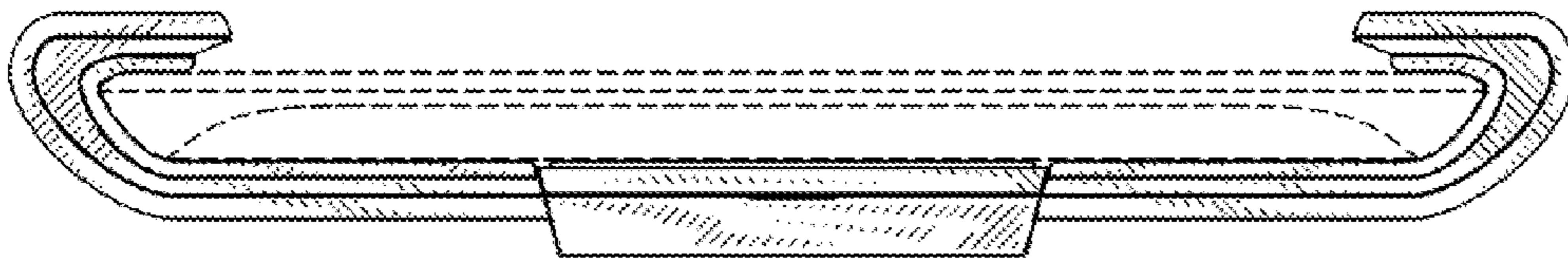

Fig. 14