

US00D664540S

(12) **United States Design Patent**  
**Kim et al.**

(10) **Patent No.:** **US D664,540 S**  
(45) **Date of Patent:** **\*\* Jul. 31, 2012**

(54) **TABLET COMPUTER**

(75) Inventors: **Ik-Sang Kim**, Seoul (KR); **Min-Jung Kim**, Kyunggi-do (KR)

(73) Assignee: **Samsung Electronics Co., Ltd.**, Suwon (KR)

(\*\*) Term: **14 Years**

(21) Appl. No.: **29/390,464**

(22) Filed: **Apr. 25, 2011**

(30) **Foreign Application Priority Data**

Jan. 13, 2011 (KR) ..... 30-2011-0001451

(51) **LOC (9) Cl.** ..... **14-02**

(52) **U.S. Cl.** ..... **D14/341**

(58) **Field of Classification Search** ..... D14/341-347, D14/137, 138, 138.1, 138 A, 138 AA, 138 R, D14/138 AB, 138 AC, 138 AD, 138 C, 138 G, D14/496, 203.1, 203.3, 203.4, 203.5, 203.7, D14/426, 427, 432, 429, 129, 130, 420, 439-441, D14/448, 125, 126, 147, 156, 218, 247-248, D14/250, 389, 388, 315-318; D10/65, 104; D18/6-7; D21/324, 329, 330; D19/26, 59, D19/60; 455/556.1, 556.2, 566, 575.1, 90.3; 379/433.04, 433.01, 433.06, 916; 345/169, 345/173, 901, 905; 361/679.26, 679.27, 361/679.3, 679.55, 679.56

See application file for complete search history.

(56) **References Cited**

**U.S. PATENT DOCUMENTS**

D270,061 S \* 8/1983 Ackeret ..... D6/308  
D284,084 S 6/1986 Ferrara, Jr.  
D306,583 S 3/1990 Krolopp et al.  
D333,574 S \* 3/1993 Ackeret ..... D6/300  
D337,569 S 7/1993 Kando  
D490,420 S \* 5/2004 Solomon et al. .... D14/341  
D500,991 S 1/2005 Niitsu  
D504,889 S 5/2005 Andre et al.  
D532,791 S \* 11/2006 Kim ..... D14/203.7

D558,460 S \* 1/2008 Yu et al. .... D6/308  
D563,804 S 3/2008 Kimura et al.  
D579,930 S \* 11/2008 Maskatia ..... D14/341  
D584,738 S 1/2009 Kim et al.  
D590,374 S 4/2009 Madonna et al.  
D592,214 S 5/2009 Bradford  
D602,014 S 10/2009 Andre et al.  
D602,487 S \* 10/2009 Maskatia ..... D14/341  
D605,626 S 12/2009 Park  
D610,582 S 2/2010 Sugitani et al.  
D611,364 S 3/2010 Lenz et al.  
D613,510 S 4/2010 Tzeng et al.  
D613,951 S 4/2010 Tang et al.

(Continued)

**FOREIGN PATENT DOCUMENTS**

KR 3005985190000 5/2011

(Continued)

**OTHER PUBLICATIONS**

U.S. Appl. No. 29/390,462, Applicant: Kim, et al., filed Apr. 25, 2011 entitled Tablet Computer.

(Continued)

*Primary Examiner* — Barbara Fox

(74) *Attorney, Agent, or Firm* — Wood, Herron & Evans, LLP

(57) **CLAIM**

The ornamental design for a tablet computer, as shown and described.

**DESCRIPTION**

FIG. 1 is a top front perspective view of a tablet computer showing our new design;  
FIG. 2 is a front elevational view thereof;  
FIG. 3 is a rear elevational view thereof;  
FIG. 4 is a left side elevational view thereof;  
FIG. 5 is a right side elevational view thereof;  
FIG. 6 is a top plan view thereof; and,  
FIG. 7 is a bottom plan view thereof.

**1 Claim, 3 Drawing Sheets**

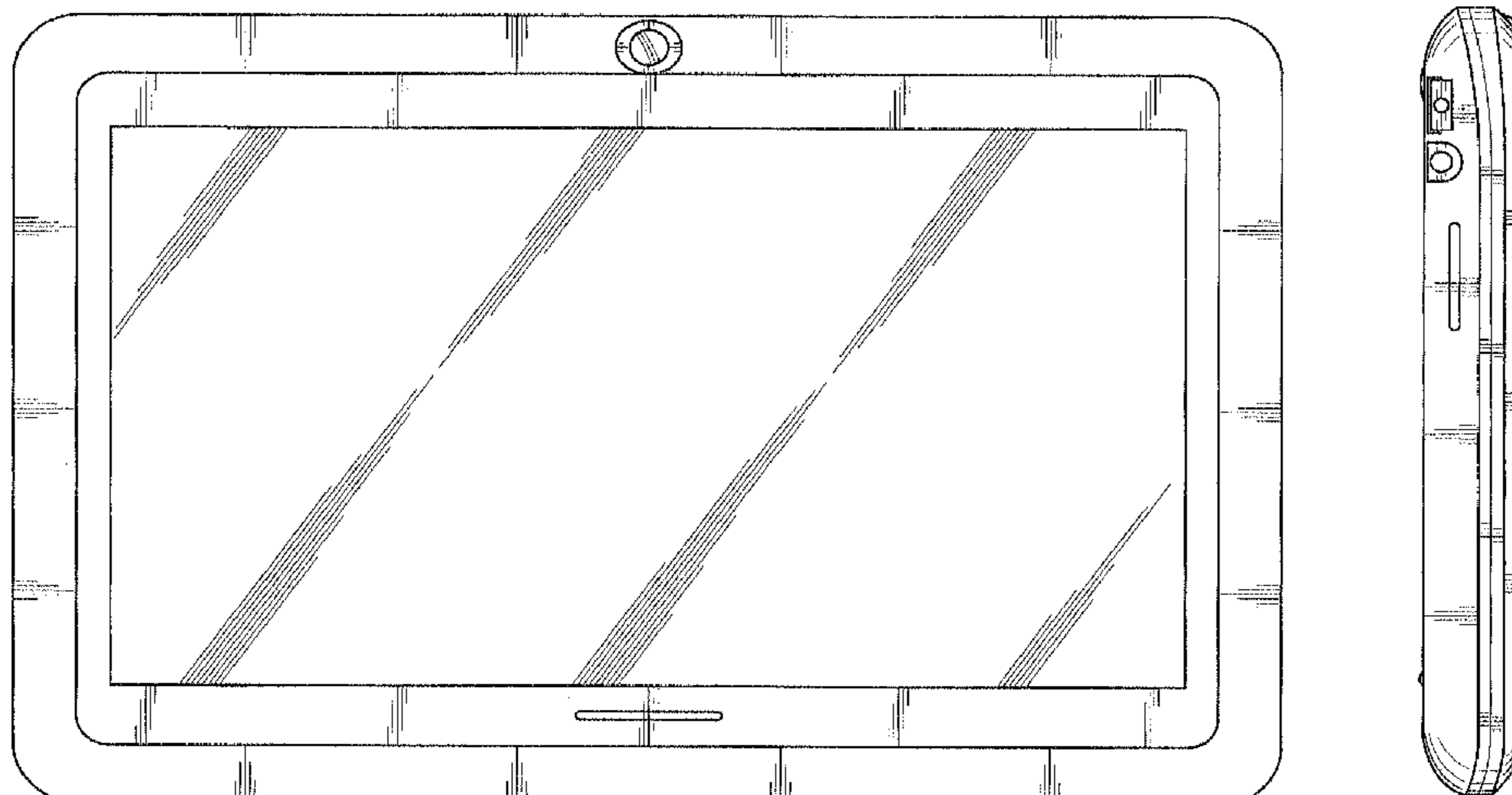

# US D664,540 S

Page 2

## U.S. PATENT DOCUMENTS

D617,793 S \* 6/2010 Chiang et al. .... D14/341  
D622,270 S 8/2010 Andre et al.  
D625,306 S \* 10/2010 Miyawaki ..... D14/341  
D627,667 S 11/2010 Lenz et al.  
D628,913 S 12/2010 Cheng  
D629,799 S 12/2010 Andre et al.  
D636,391 S \* 4/2011 Shen et al. .... D14/341  
D636,769 S \* 4/2011 Wood et al. .... D14/341  
D638,412 S \* 5/2011 Lee ..... D14/250  
D639,805 S \* 6/2011 Song et al. .... D14/341  
D640,220 S \* 6/2011 Shyu et al. .... D14/138 G  
D640,255 S 6/2011 Lee et al.  
D641,018 S \* 7/2011 Lee et al. .... D14/341  
D646,902 S \* 10/2011 Woo et al. .... D6/308  
D650,381 S \* 12/2011 Park et al. .... D14/341  
D654,893 S \* 2/2012 Jung ..... D14/138 G  
2009/0231292 A1 9/2009 Hsieh et al.

## FOREIGN PATENT DOCUMENTS

KR 3005994750000 5/2011  
KR 3006004150000 6/2011  
KR 3006004300000 6/2011  
KR 3006046440000 7/2011

## OTHER PUBLICATIONS

U.S. Appl. No. 29/390,463, Applicant: Kim, et al., filed Apr. 25, 2011  
entitled Tablet Computer.

U.S. Appl. No. 29/372,112, Applicant EunuaeShally Lee et al., filed  
Oct. 15, 2010, title Tablet Computer.

\* cited by examiner

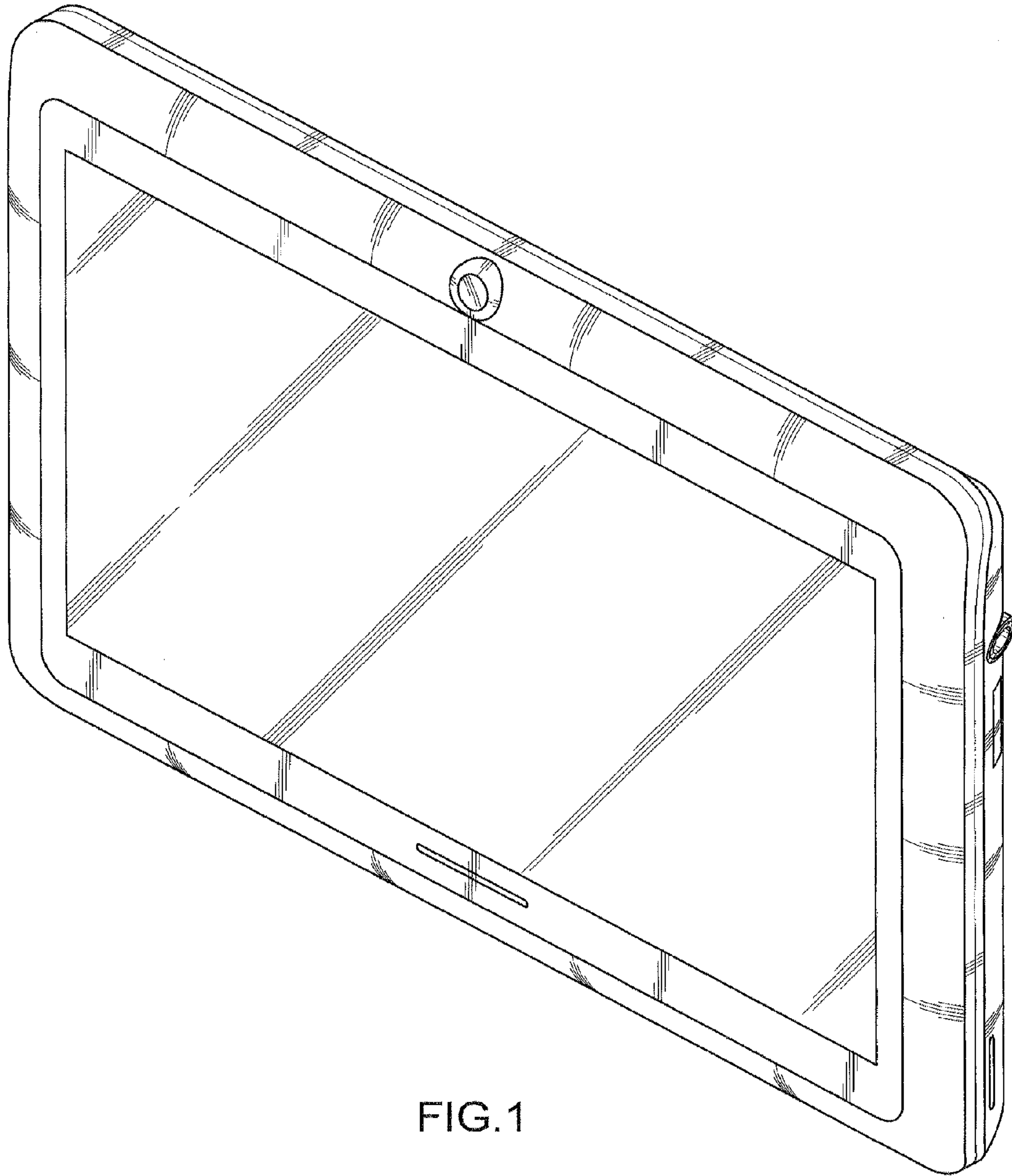

FIG. 1

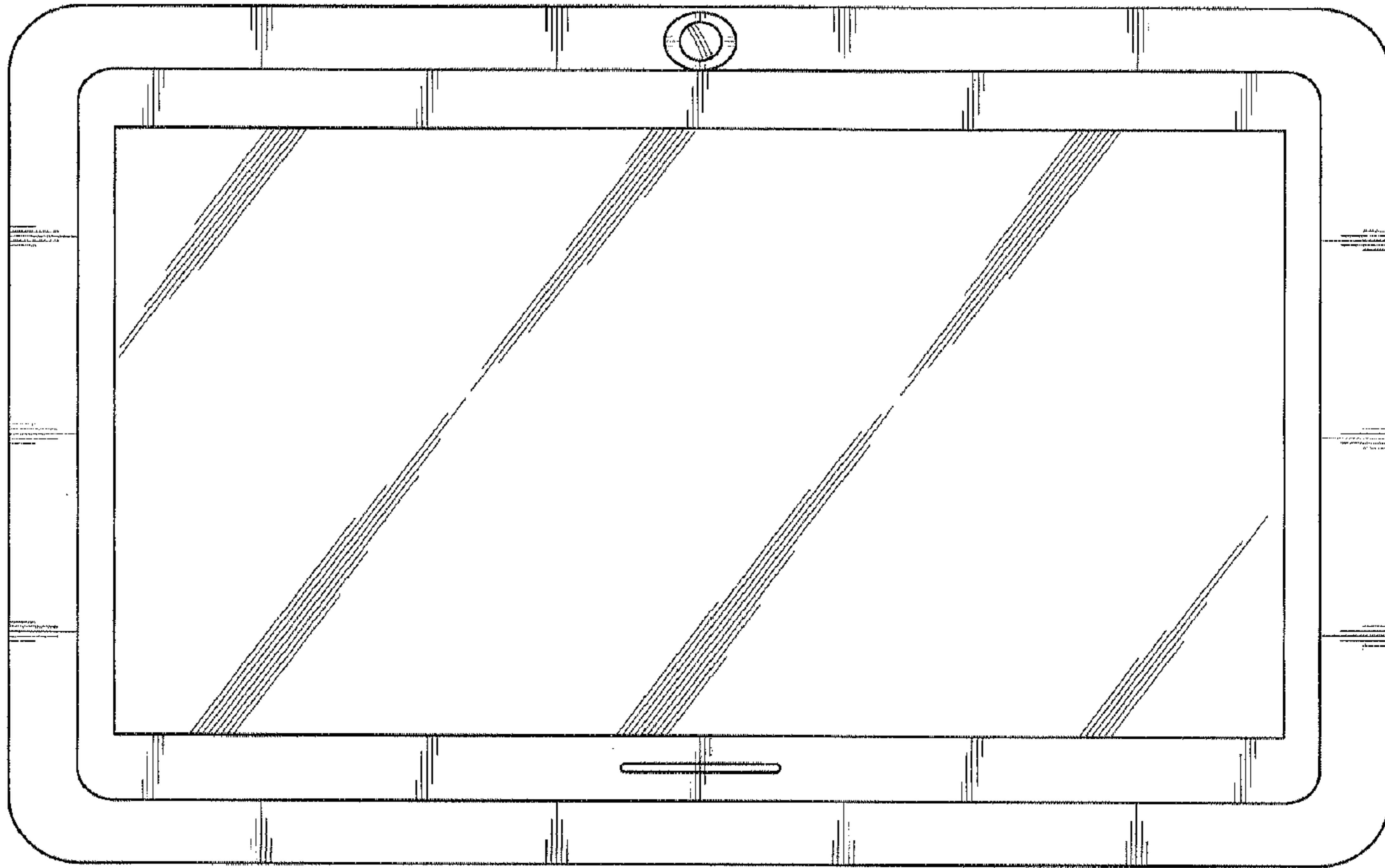

FIG. 2

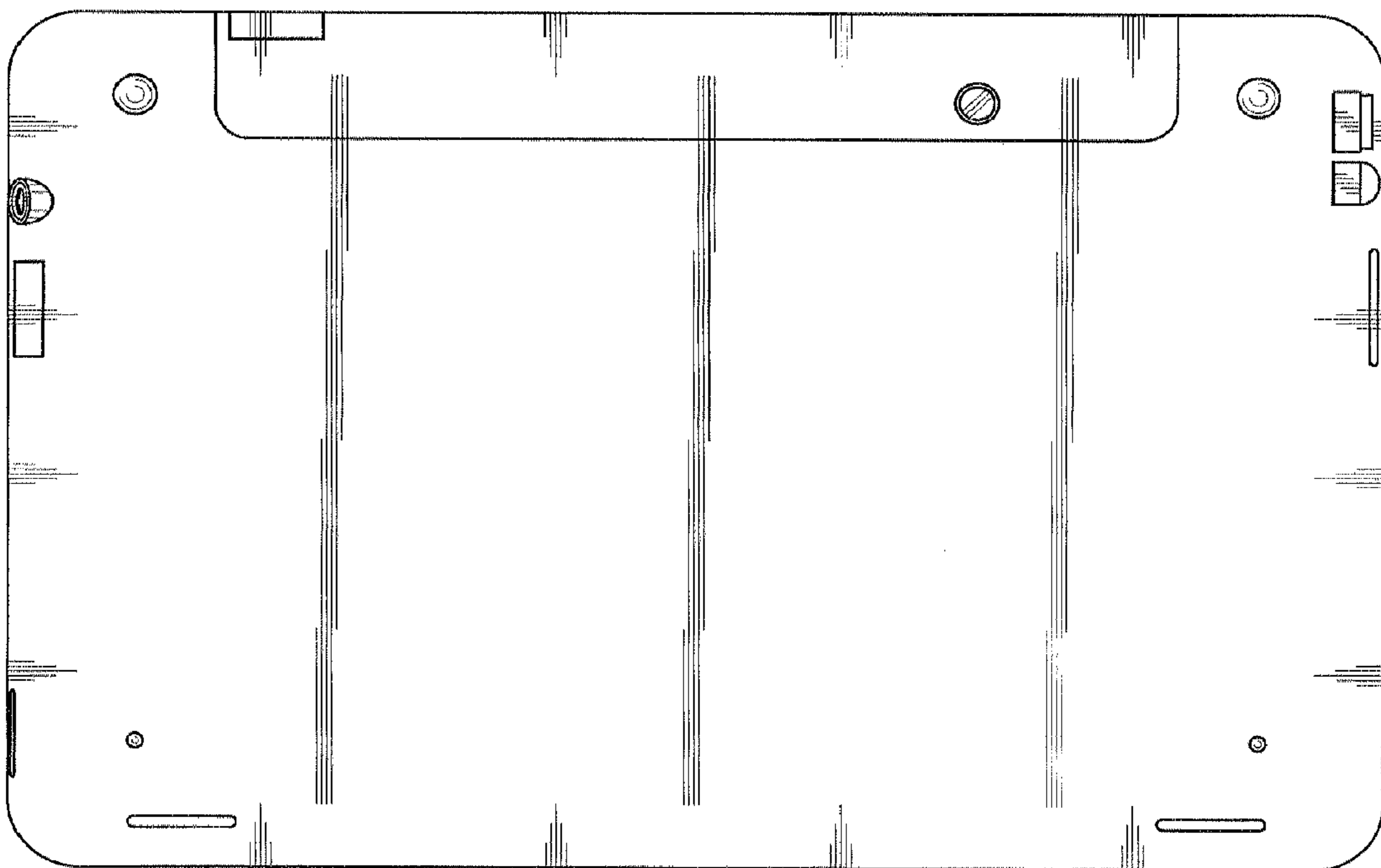

FIG. 3

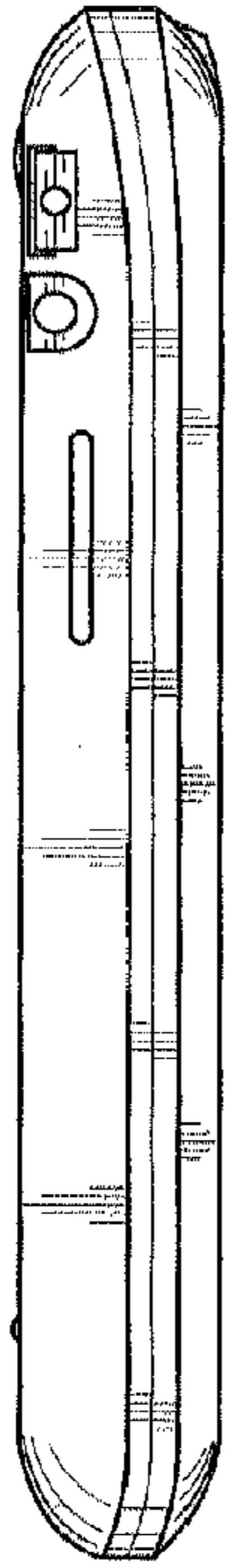

FIG. 4



FIG. 5

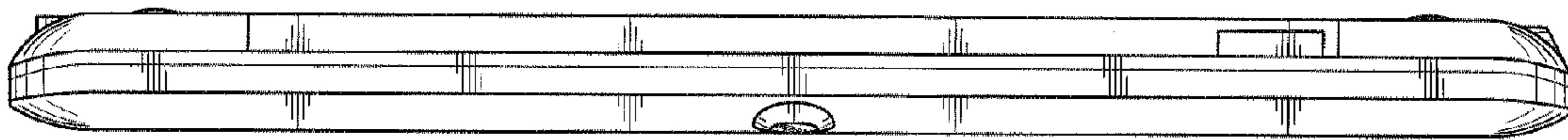

FIG. 6

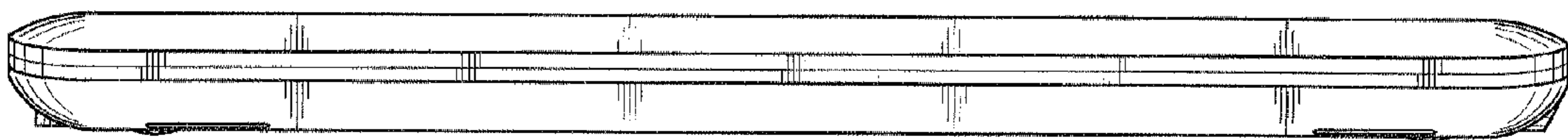

FIG. 7