



US00D664480S

(12) **United States Design Patent**
Platto et al.

(10) **Patent No.:** **US D664,480 S**
(45) **Date of Patent:** **** Jul. 31, 2012**

(54) **VEHICLE UPPER GRILLE**
(75) Inventors: **Gordon M Platto**, Troy, MI (US); **Earl Clyde Lucas**, Brentwood (GB); **Dean Carbis**, Surth (DE)

D603,305 S * 11/2009 Woolley et al. D12/163
D604,210 S * 11/2009 Kim D12/163
D609,140 S * 2/2010 Iwasaki D12/163
D610,052 S * 2/2010 Watanabe D12/163
D630,975 S * 1/2011 Sperling et al. D12/163
D631,405 S * 1/2011 Kuze D12/163

(73) Assignee: **Ford Motor Company**, Dearborn, MI (US)

OTHER PUBLICATIONS

Ford Taurus, New York International Auto Show, Apr. 25, 2011.

(**) Term: **14 Years**

* cited by examiner

(21) Appl. No.: **29/393,570**

Primary Examiner — Melody N Brown

(22) Filed: **Jun. 7, 2011**

(74) *Attorney, Agent, or Firm* — Damian Porcari

(51) **LOC (9) Cl.** **12-16**

(57) **CLAIM**

(52) **U.S. Cl.** **D12/163**

The ornamental design for a vehicle upper grille, as shown and described.

(58) **Field of Classification Search** D12/163,
D12/196, 171, 169, 216, 90-92, 86; 180/68.1,
180/68.6; 296/193.11

DESCRIPTION

See application file for complete search history.

FIG. 1 is a top plan view of a vehicle upper grille;
FIG. 2 is a bottom plan view of the vehicle upper grille;
FIG. 3 is a front elevational view of the vehicle upper grille;
FIG. 4 is a left side elevational view of the vehicle upper grille;
FIG. 5 is a right side elevational view of the vehicle upper grille; and,
FIG. 6 is a perspective view of the vehicle upper grille.

(56) **References Cited**

U.S. PATENT DOCUMENTS

D533,484 S * 12/2006 Behmer et al. D12/163
D535,223 S * 1/2007 Gaffka et al. D12/163
D560,572 S * 1/2008 Okamoto et al. D12/163
D562,196 S * 2/2008 Saito D12/163
D590,754 S * 4/2009 Woolley et al. D12/169

1 Claim, 6 Drawing Sheets

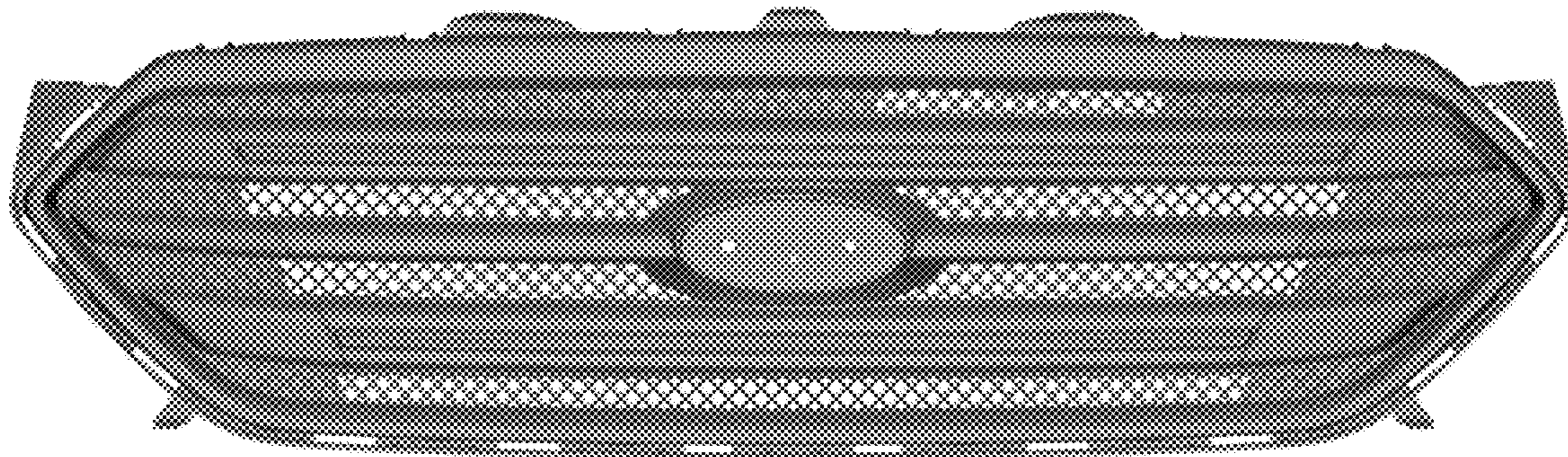

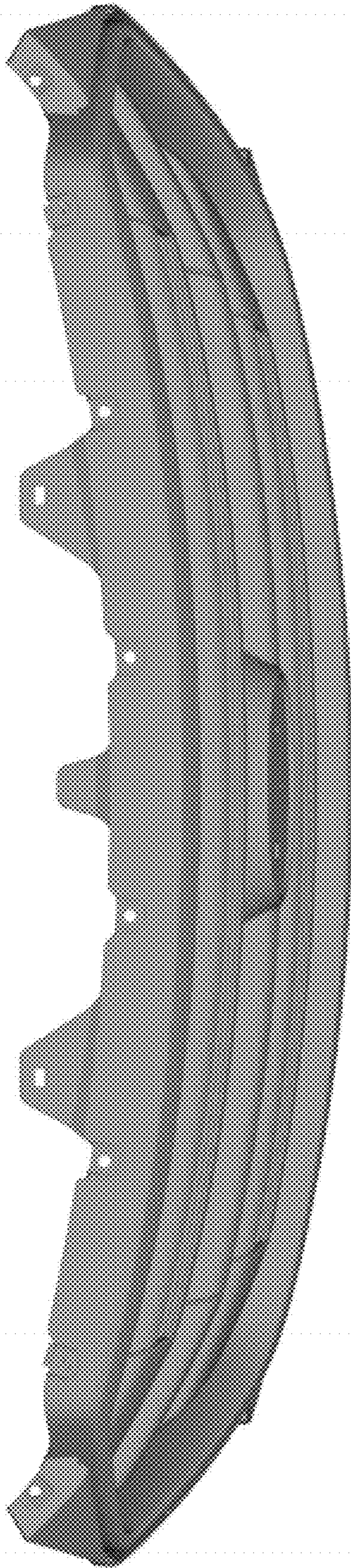

Figure 1

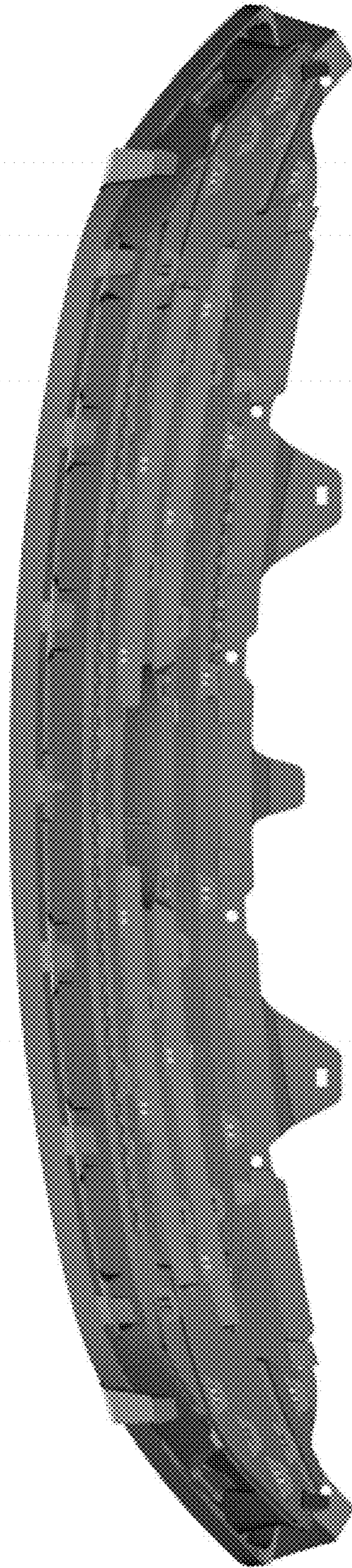

Figure 2

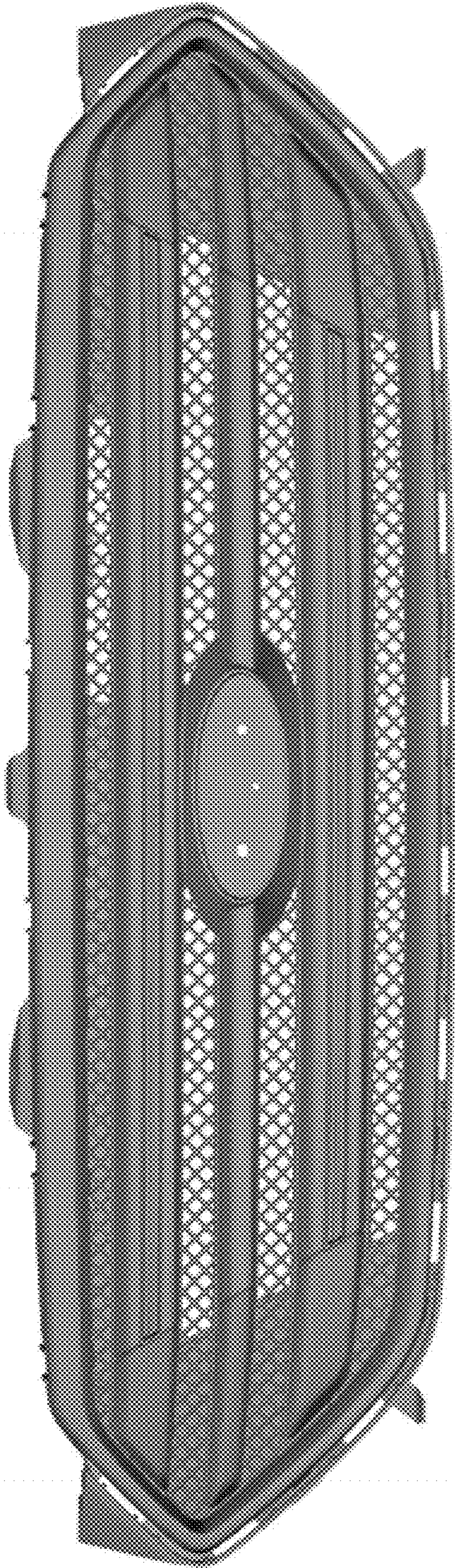

Figure 3

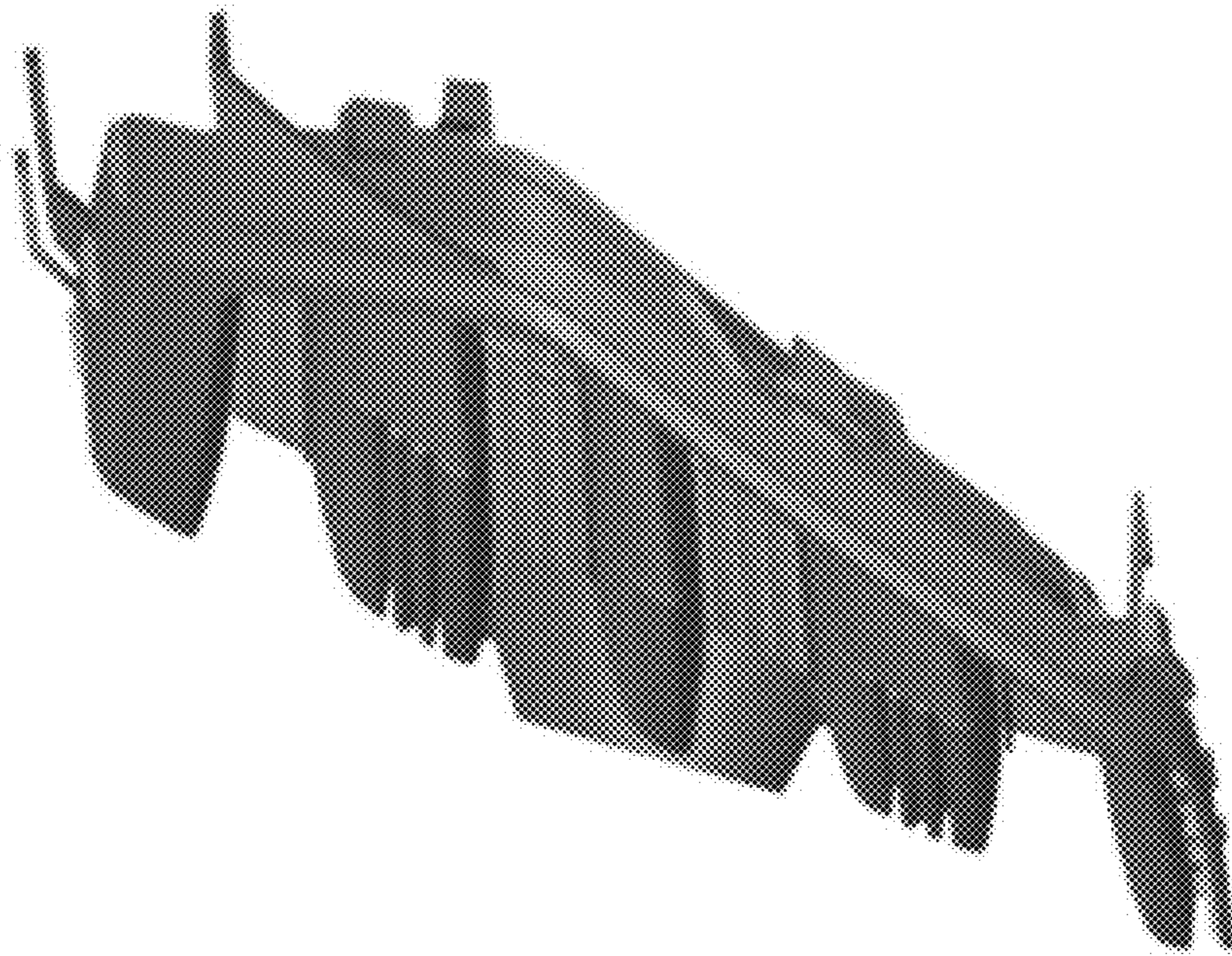

Figure 4

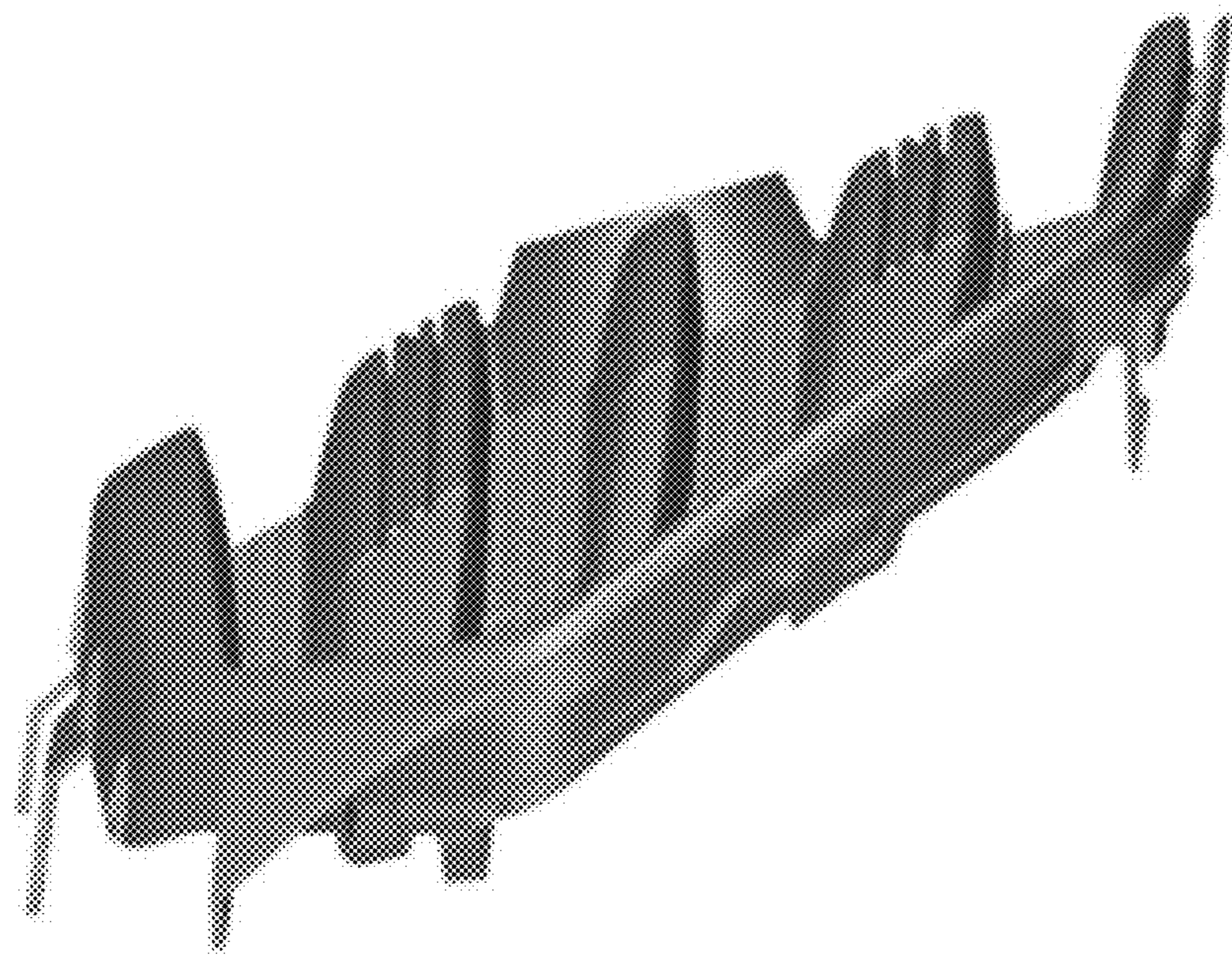

Figure 5

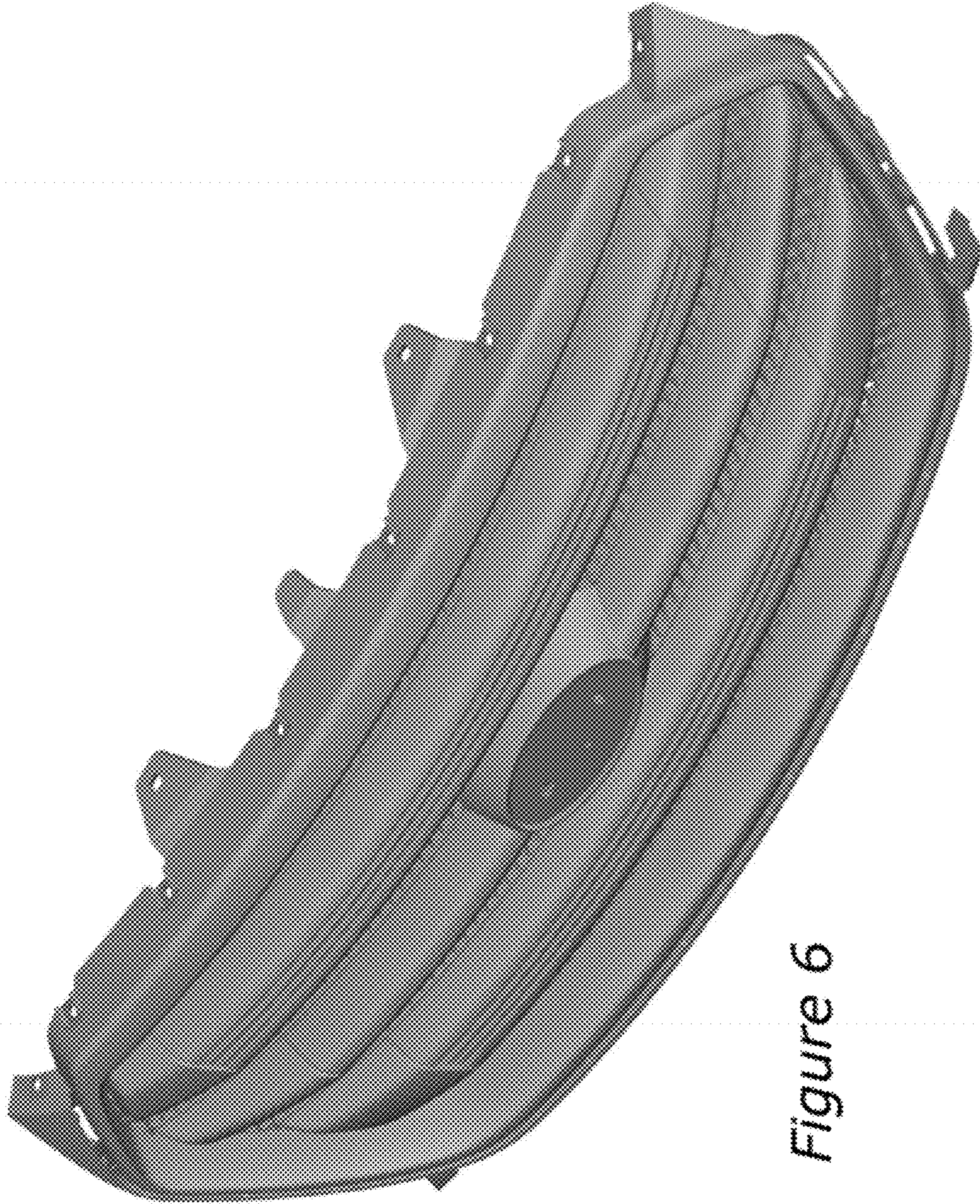

Figure 6