



US00D664479S

(12) **United States Design Patent**
Platto et al.

(10) **Patent No.:** **US D664,479 S**
(45) **Date of Patent:** **** Jul. 31, 2012**

- (54) **VEHICLE UPPER GRILLE**
- (75) Inventors: **Gordon M Platto**, Troy, MI (US); **Earl Clyde Lucas**, Brentwood (GB); **Dean Carbis**, Cologne (DE)
- (73) Assignee: **Ford Motor Company**, Dearborn, MI (US)
- (**) Term: **14 Years**
- (21) Appl. No.: **29/393,569**
- (22) Filed: **Jun. 7, 2011**
- (51) **LOC (9) Cl.** **12-16**
- (52) **U.S. Cl.** **D12/163**
- (58) **Field of Classification Search** D12/163,
D12/196, 171, 169, 216, 90-92, 86; 180/68.1,
180/68.6; 296/193.11
See application file for complete search history.

- D562,196 S * 2/2008 Saito D12/163
- D603,305 S * 11/2009 Woolley et al. D12/163
- D609,140 S * 2/2010 Iwasaki D12/163

OTHER PUBLICATIONS

Ford Taurus, New York International Auto Show, Apr. 25, 2011.

* cited by examiner

Primary Examiner — Melody N Brown

(74) *Attorney, Agent, or Firm* — Damian Porcari

(57) **CLAIM**

The ornamental design for a vehicle upper grille, as shown and described.

DESCRIPTION

FIG. 1 is a top plan view of a vehicle upper grille;
 FIG. 2 is a bottom plan view of the vehicle upper grille;
 FIG. 3 is a front elevational view of the vehicle upper grille;
 FIG. 4 is a left side elevational view of the vehicle upper grille;
 FIG. 5 is a right side elevational view of the vehicle upper grille; and,
 FIG. 6 is a perspective view of the vehicle upper grille.

1 Claim, 6 Drawing Sheets

(56) **References Cited**

U.S. PATENT DOCUMENTS

- D533,484 S * 12/2006 Behmer et al. D12/163
- D535,223 S * 1/2007 Gaffka et al. D12/163
- D560,572 S * 1/2008 Okamoto et al. D12/163

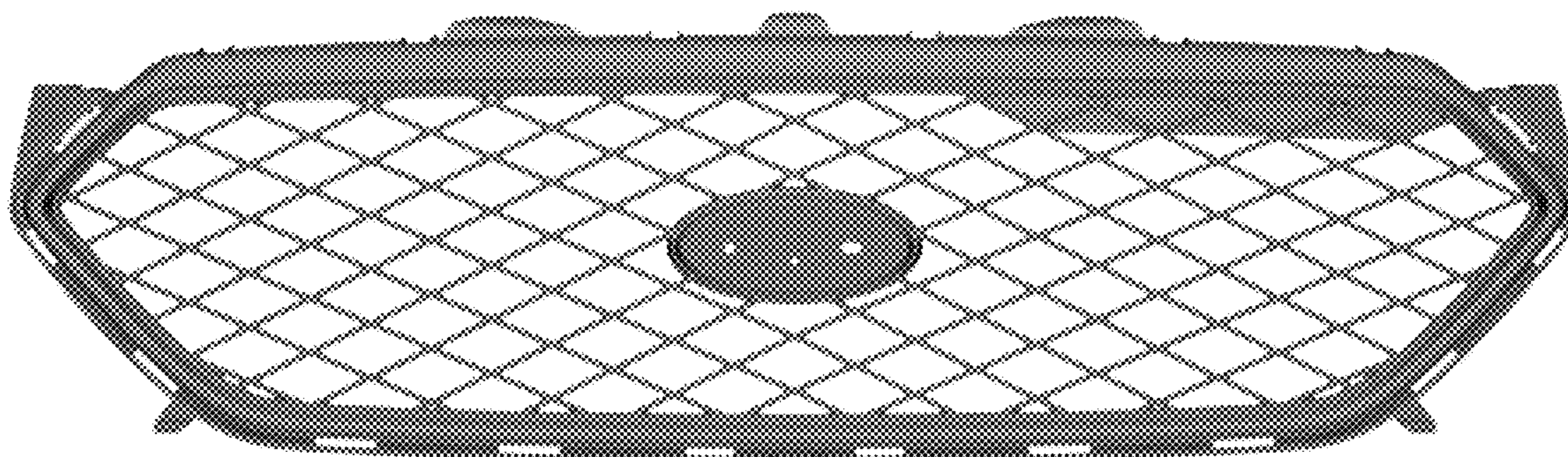

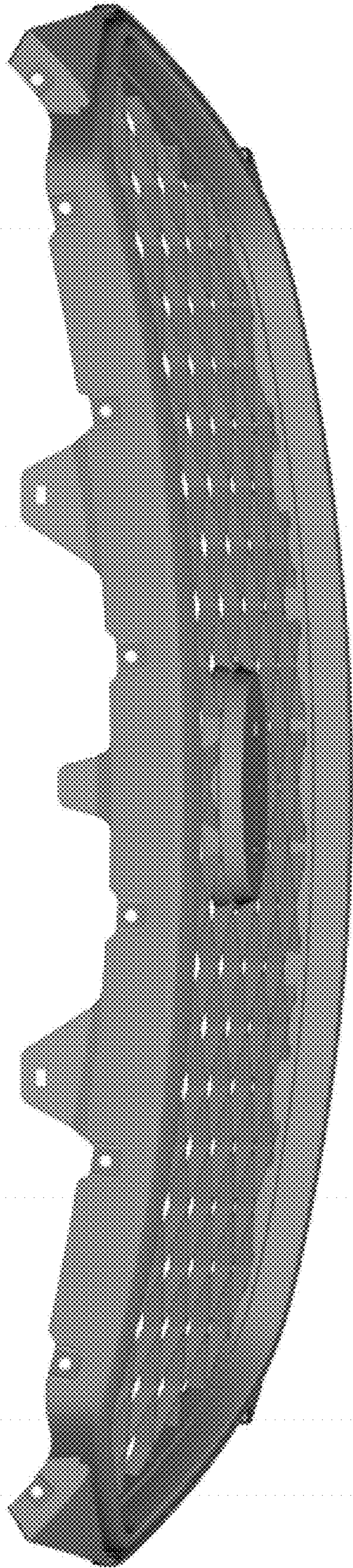

Figure 1

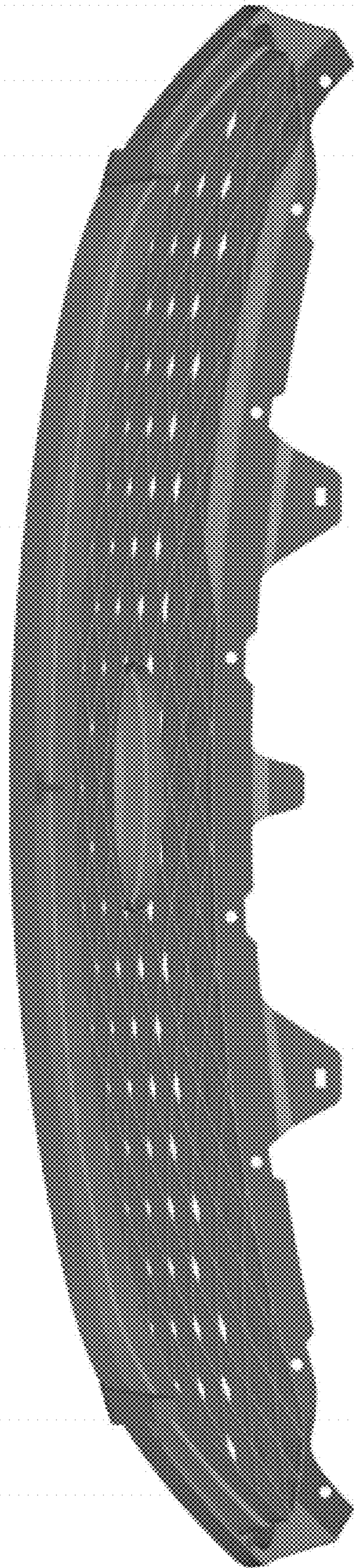

Figure 2

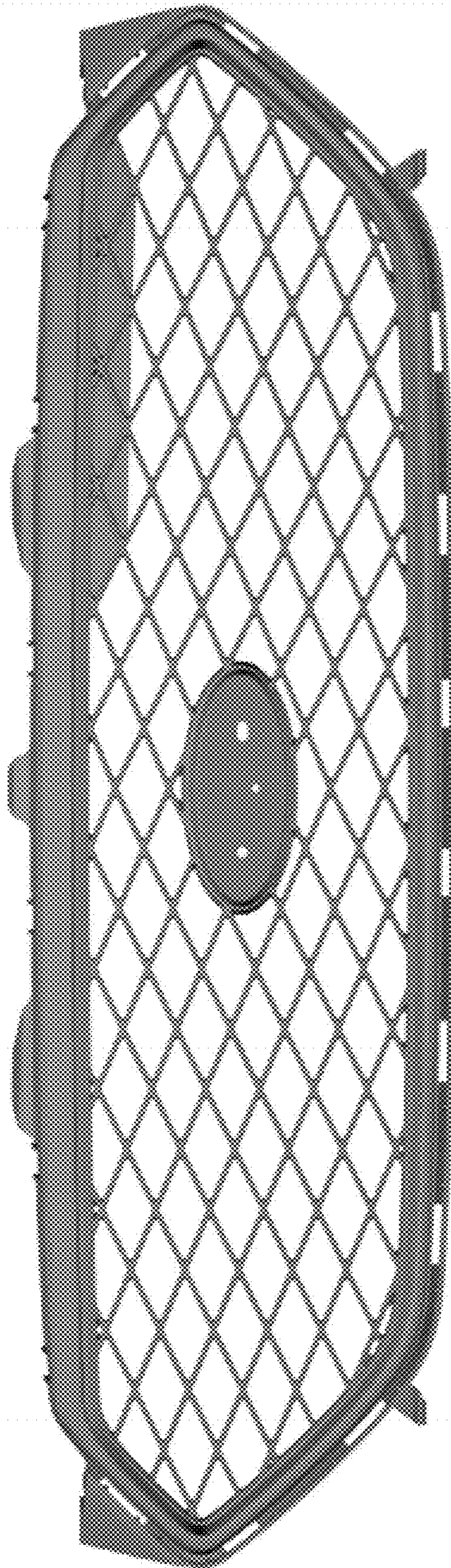

Figure 3

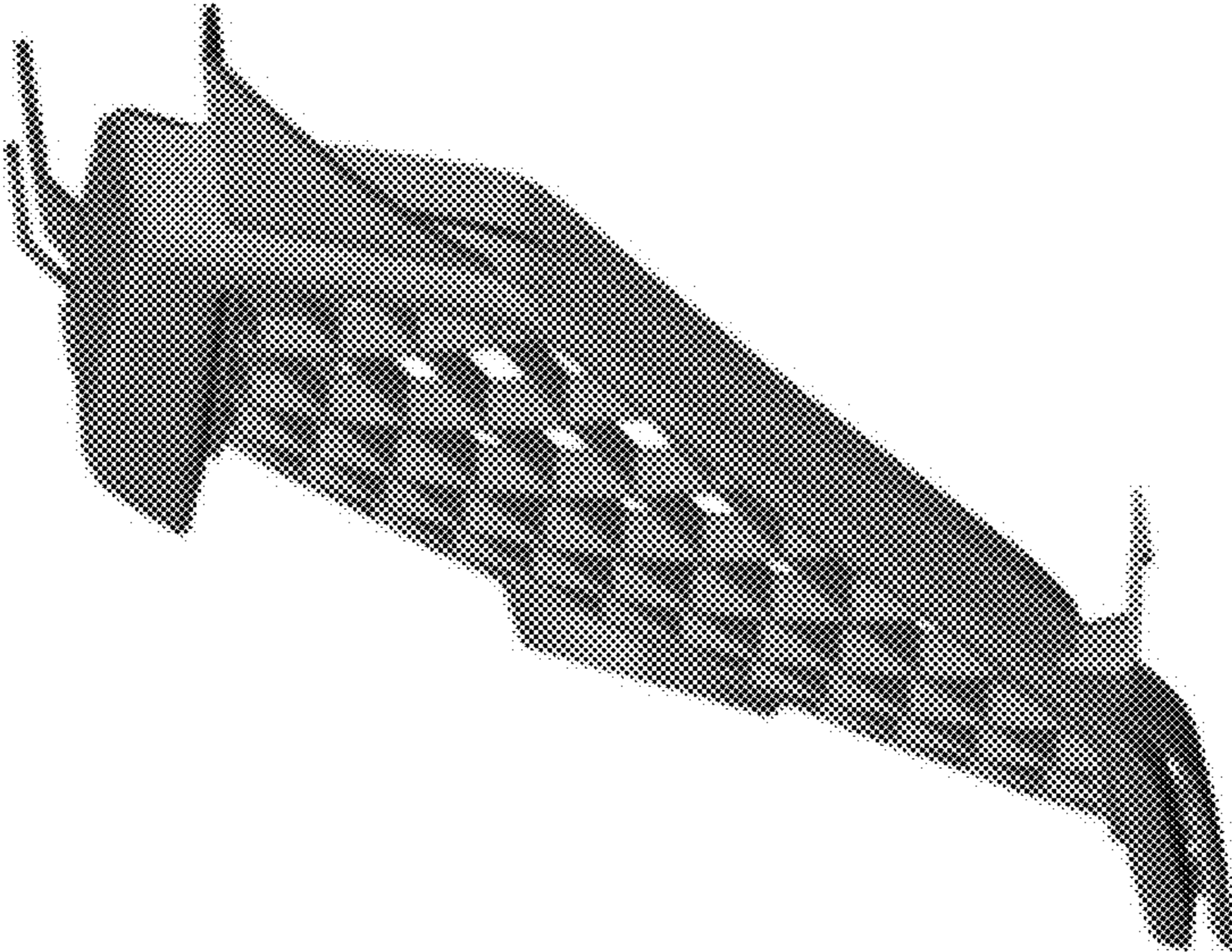

Figure 4

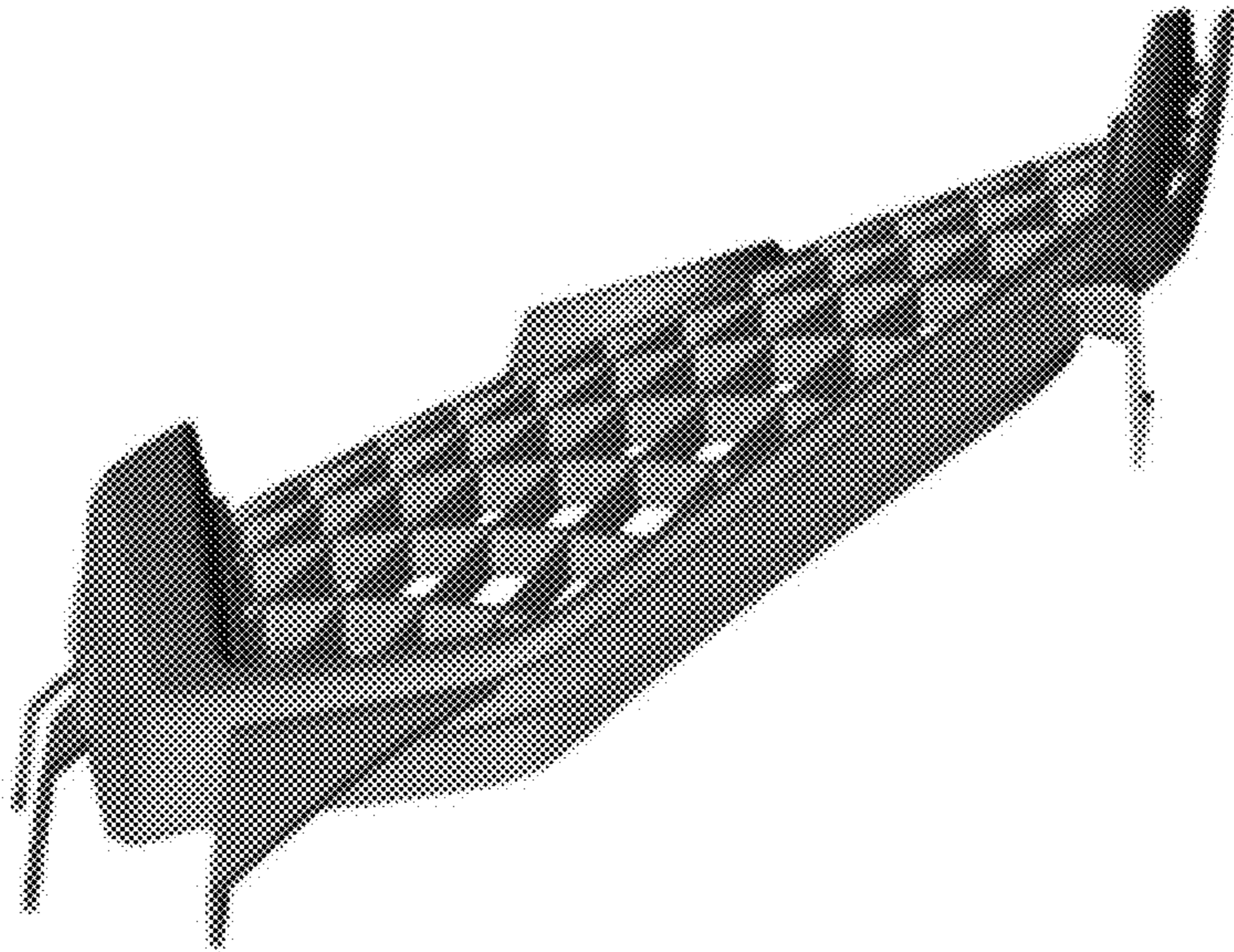

Figure 5

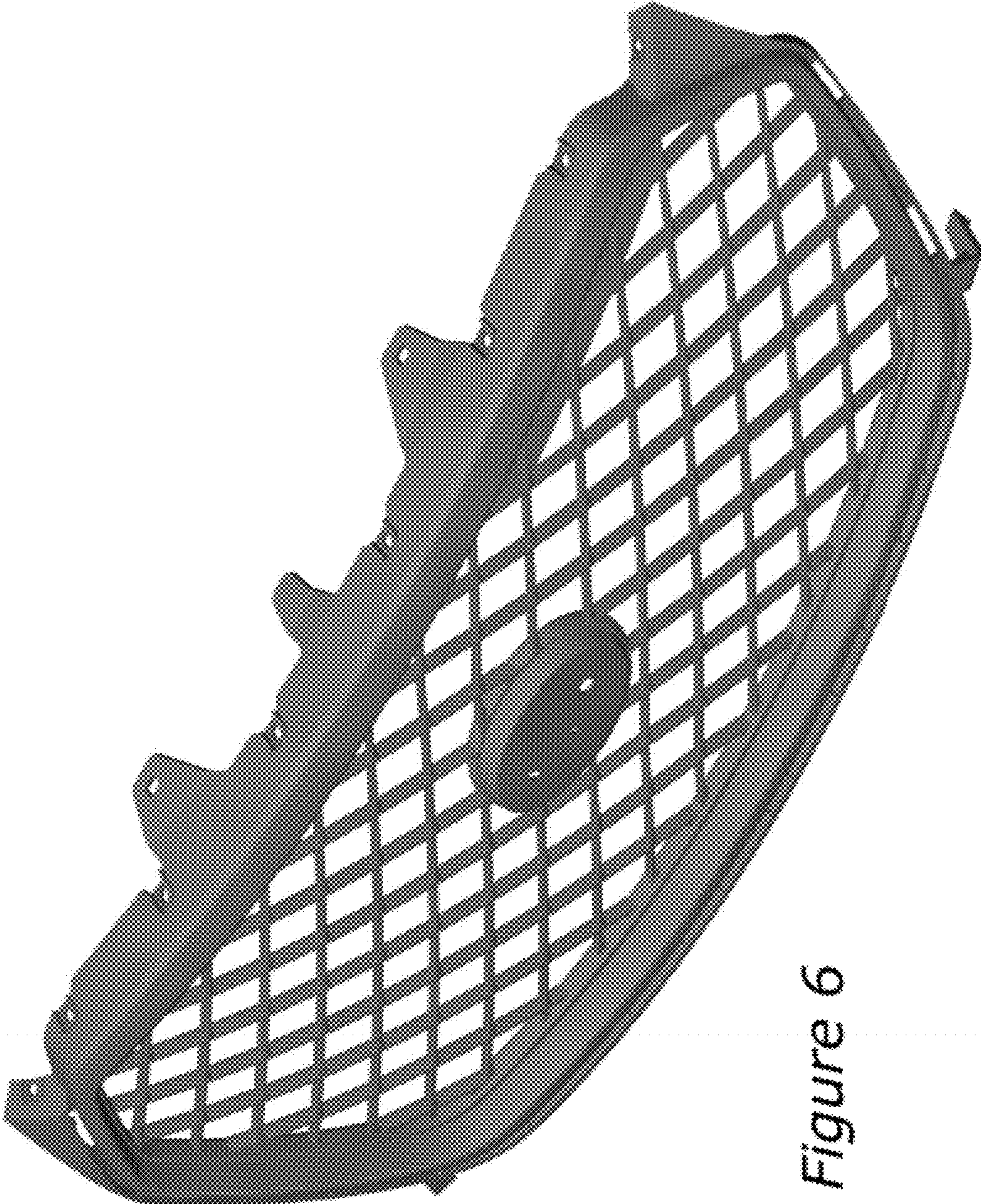

Figure 6