

US00D664327S

(12) **United States Design Patent**  
**Lauro**

(10) **Patent No.:** **US D664,327 S**  
(45) **Date of Patent:** **\*\* Jul. 31, 2012**

(54) **REAR END COVER-UP GARMENT WITH POCKETS**

(76) Inventor: **Sal T. Lauro**, Rancho Palos Verdes, CA (US)

(\*\*) Term: **14 Years**

(21) Appl. No.: **29/416,458**

(22) Filed: **Mar. 22, 2012**

(51) **LOC (9) Cl.** ..... **02-02**

(52) **U.S. Cl.** ..... **D2/728**

(58) **Field of Classification Search** ..... D2/728,  
D2/740, 823, 826, 860-864; 2/46, 48-49.2,  
2/49.4, 50-52, 69

See application file for complete search history.

(56) **References Cited**

U.S. PATENT DOCUMENTS

2,683,880	A	7/1954	Krigbaum	
2,912,698	A	11/1959	Greenblatt	
4,125,902	A	11/1978	Frank	
D396,543	S	8/1998	Owen	
D414,645	S *	10/1999	Cooper	D6/608
D478,408	S *	8/2003	Nettles	D2/861
D557,967	S *	12/2007	Grant	D6/608
D579,634	S *	11/2008	Martone	D2/823

D592,830	S *	5/2009	Whiteside	D2/823
2003/0014804	A1 *	1/2003	Morales	2/92
2006/0218690	A1	10/2006	James	
2007/0006360	A1 *	1/2007	Walker	2/88
2008/0115250	A1 *	5/2008	Tousant	2/69
2008/0208149	A1 *	8/2008	Vasquez	604/322
2010/0071110	A1	3/2010	Stevens	

\* cited by examiner

*Primary Examiner* — Rashida Johnson

(57) **CLAIM**

The ornamental design for a rear end cover-up garment with pockets, as shown and described.

**DESCRIPTION**

FIG. 1 is a perspective view of a rear end cover-up garment with pockets showing my new design;  
FIG. 2 is a front view thereof;  
FIG. 3 is a back view thereof;  
FIG. 4 is a side view thereof;  
FIG. 5 is an opposite side view thereof;  
FIG. 6 is a top view thereof; and,  
FIG. 7 is a bottom view thereof.

**1 Claim, 4 Drawing Sheets**

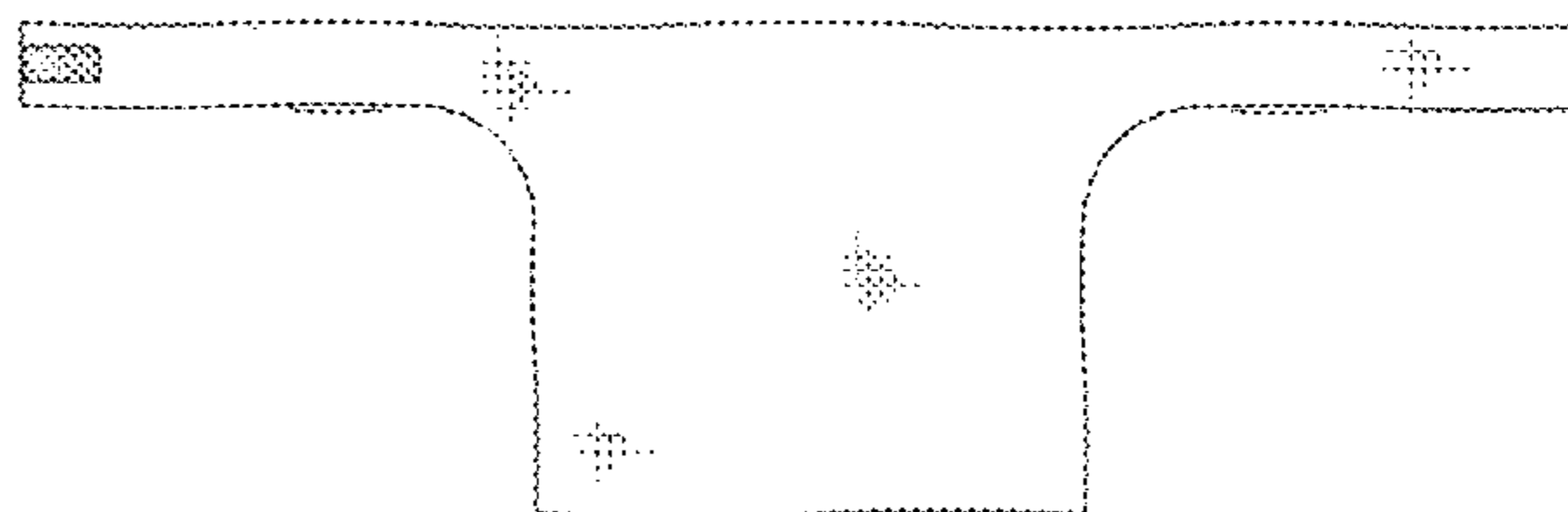
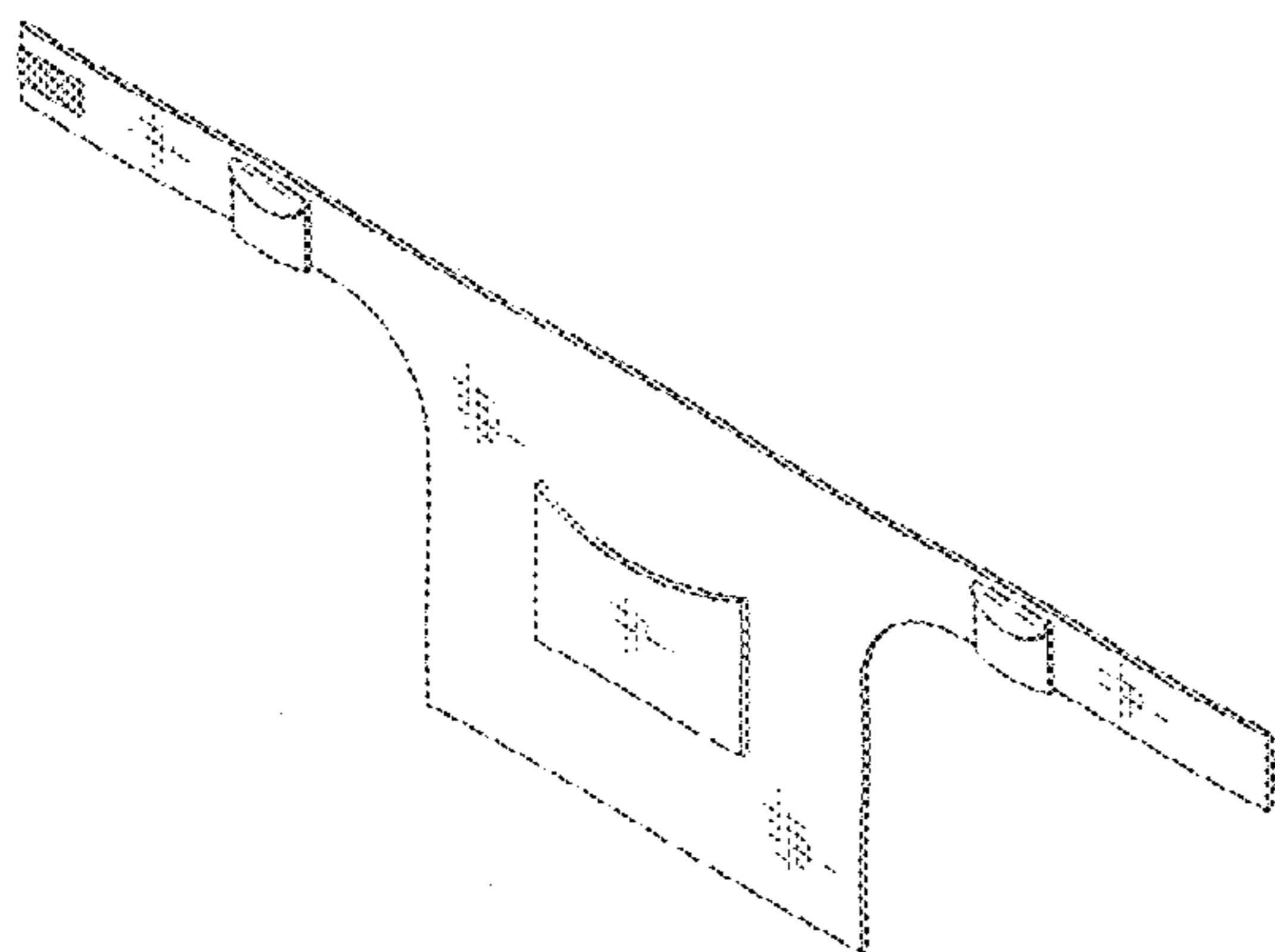

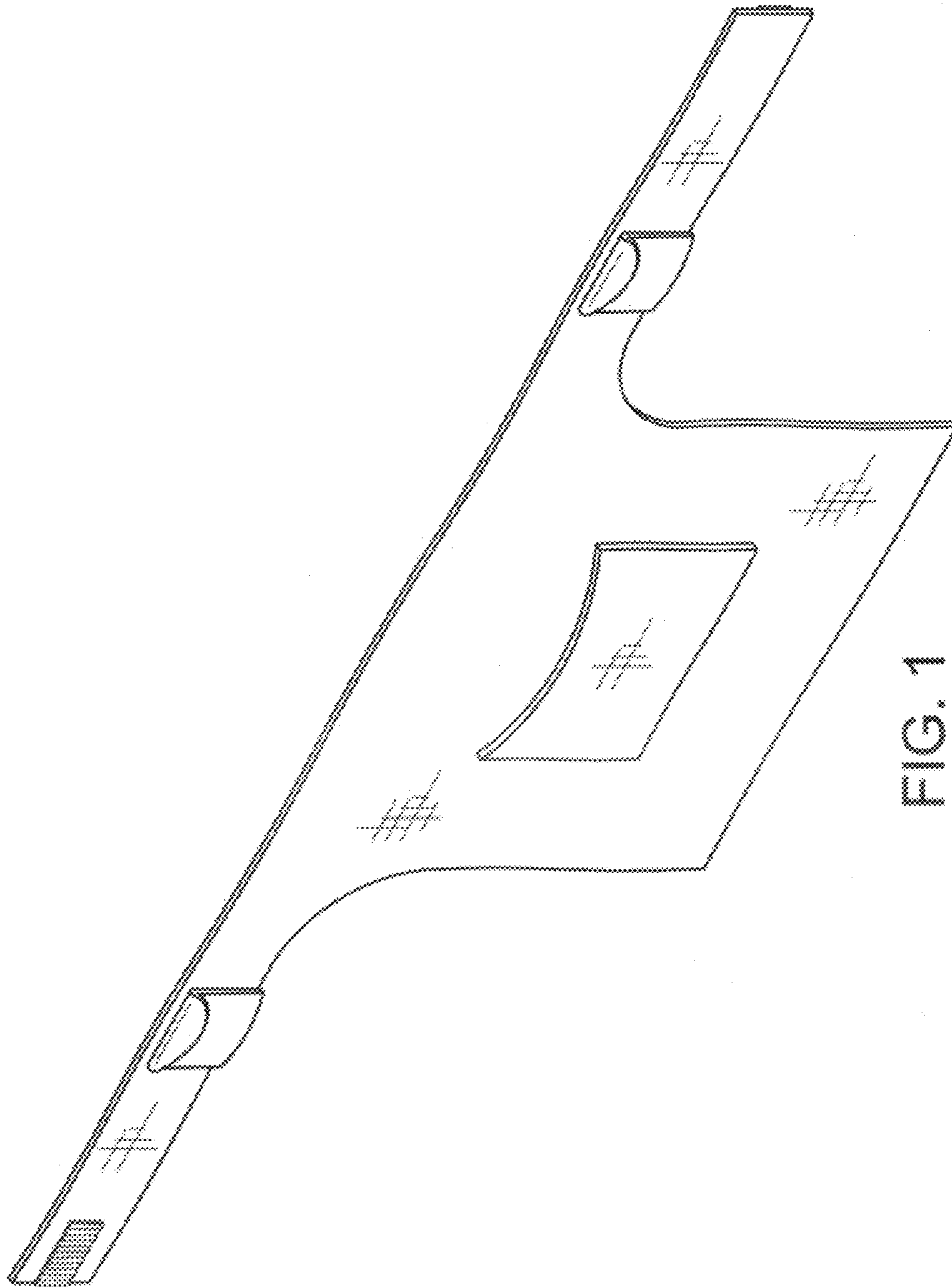

FIG. 1

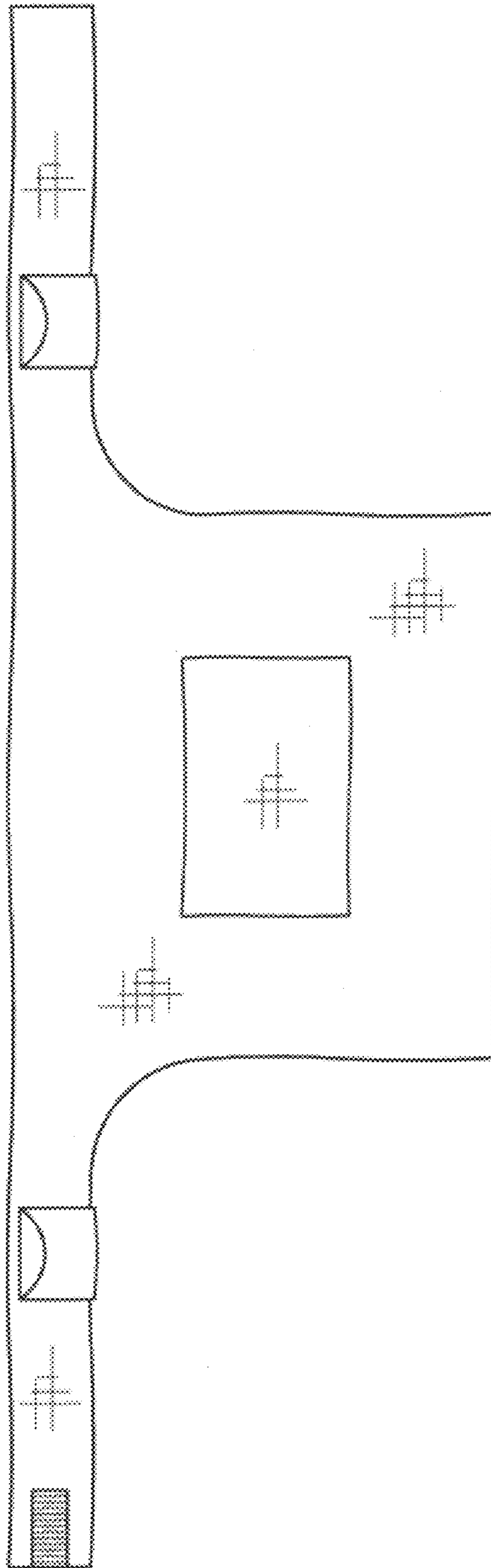

FIG. 2

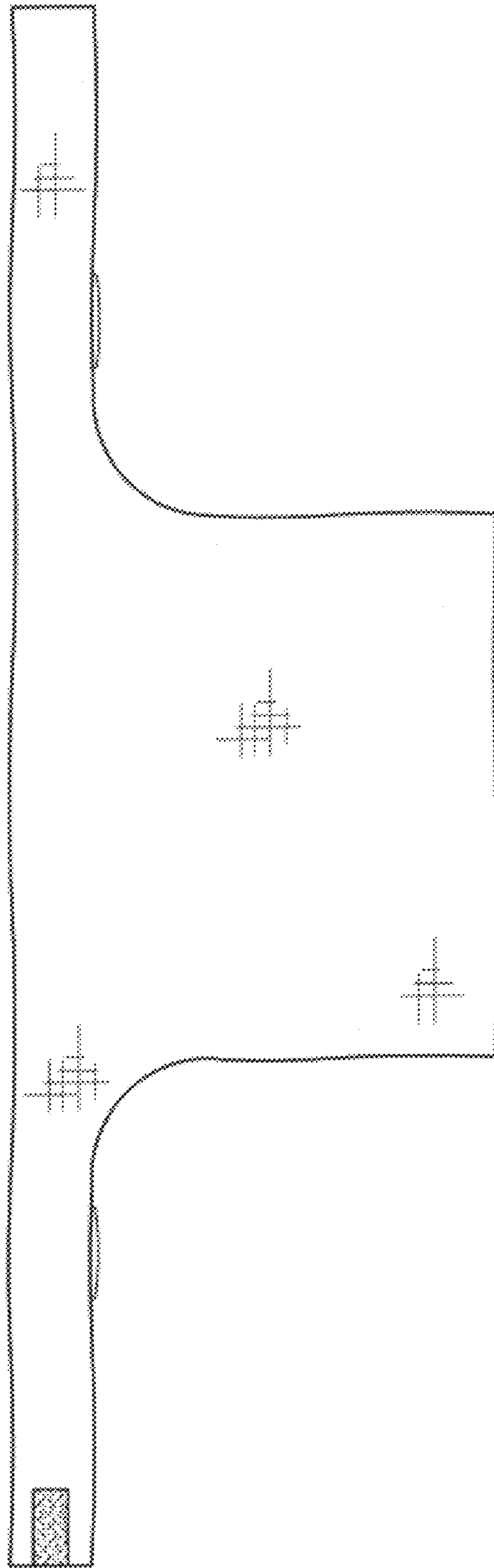

FIG. 3

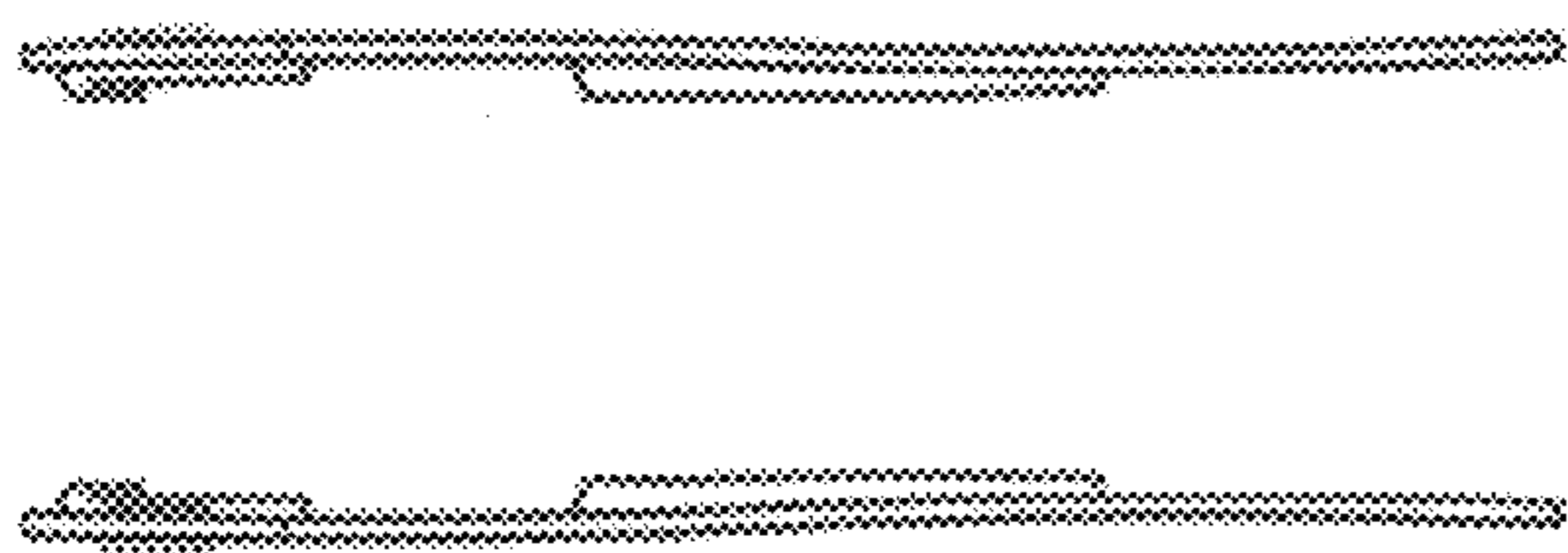

FIG. 4 FIG. 5



FIG. 6

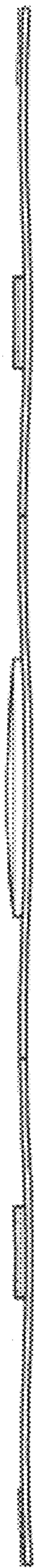

FIG. 7