

US00D664264S

(12) **United States Design Patent**
Cramer

(10) **Patent No.:** **US D664,264 S**

(45) **Date of Patent:** **** Jul. 24, 2012**

(54) **PORTABLE AWNING**

(76) Inventor: **Patricia Cramer**, Canton, GA (US)

(**) Term: **14 Years**

(21) Appl. No.: **29/397,919**

(22) Filed: **Jul. 22, 2011**

(51) **LOC (9) Cl.** **25-02**

(52) **U.S. Cl.** **D25/57**

(58) **Field of Classification Search** D25/57;
160/22, 24, 58.1, 351, 45

See application file for complete search history.

(56) **References Cited**

U.S. PATENT DOCUMENTS

- 2,888,984 A * 6/1959 Bartholomew 160/58.1
- 3,918,510 A * 11/1975 Hayward 160/45
- D532,117 S * 11/2006 Bruni D25/57

* cited by examiner

Primary Examiner — Doris Clark

(74) *Attorney, Agent, or Firm* — Thomas, Kayden, Horstemeyer & Risley, LLP

(57) **CLAIM**

The ornamental design of a portable awning, as shown and described.

DESCRIPTION

FIG. 1 is a perspective view showing my new portable awning;

FIG. 2 is a left side view thereof;

FIG. 3 is a right side view thereof;

FIG. 4 is a front view thereof;

FIG. 5 is a rear view thereof;

FIG. 6 is a top view thereof; and,

FIG. 7 is a bottom view thereof.

The broken lines are for illustrative purposes only and form no part of the claimed design.

1 Claim, 5 Drawing Sheets

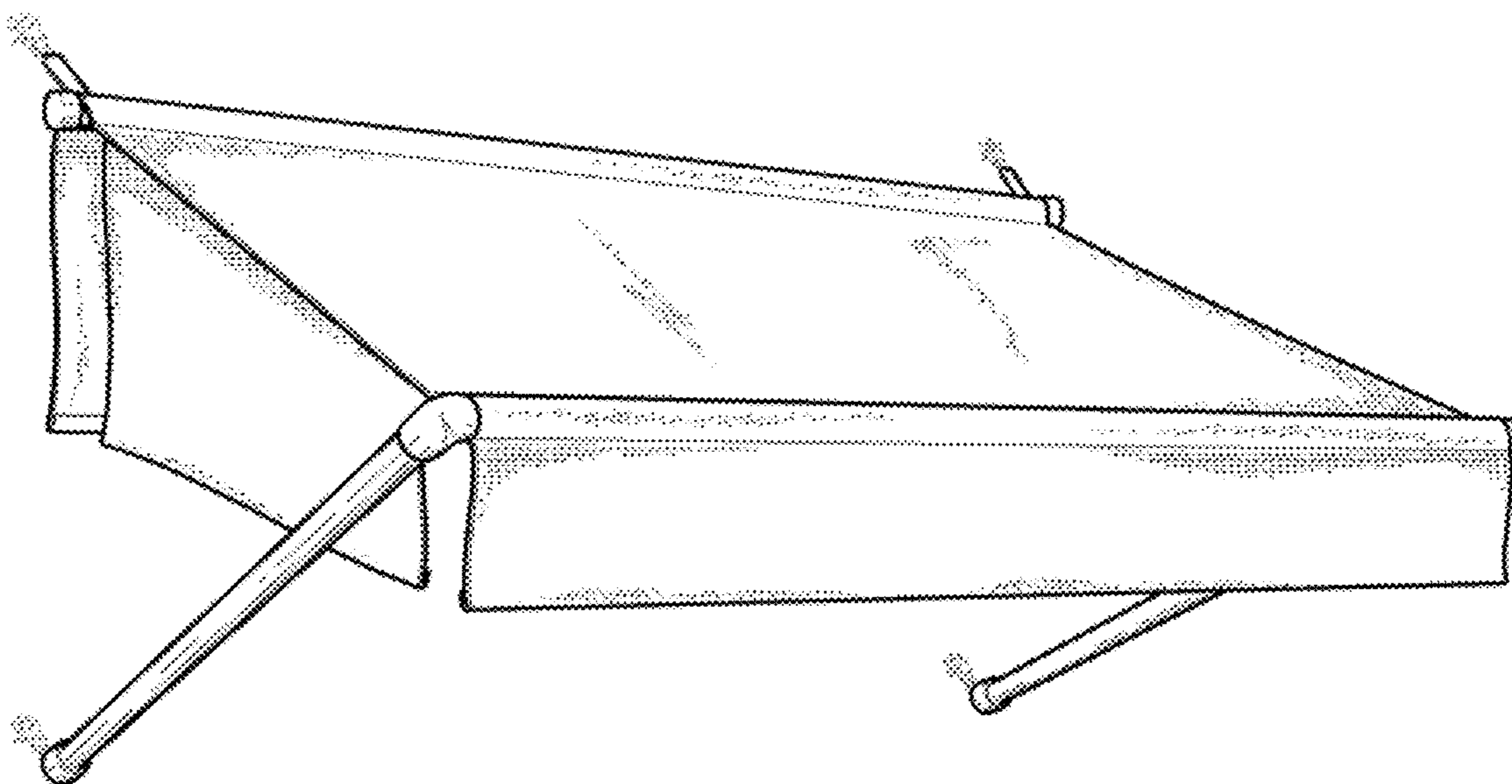

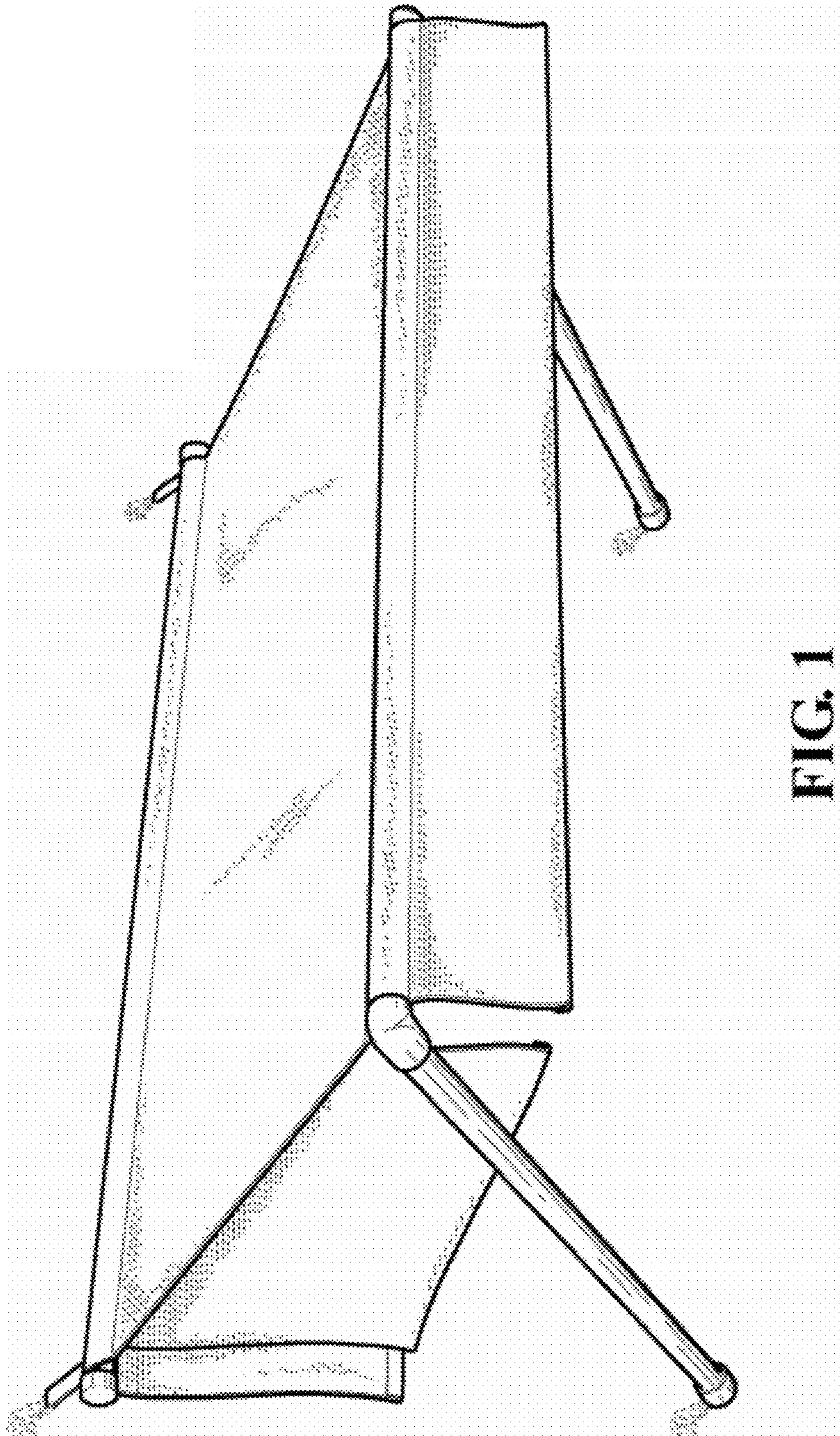

FIG. 1

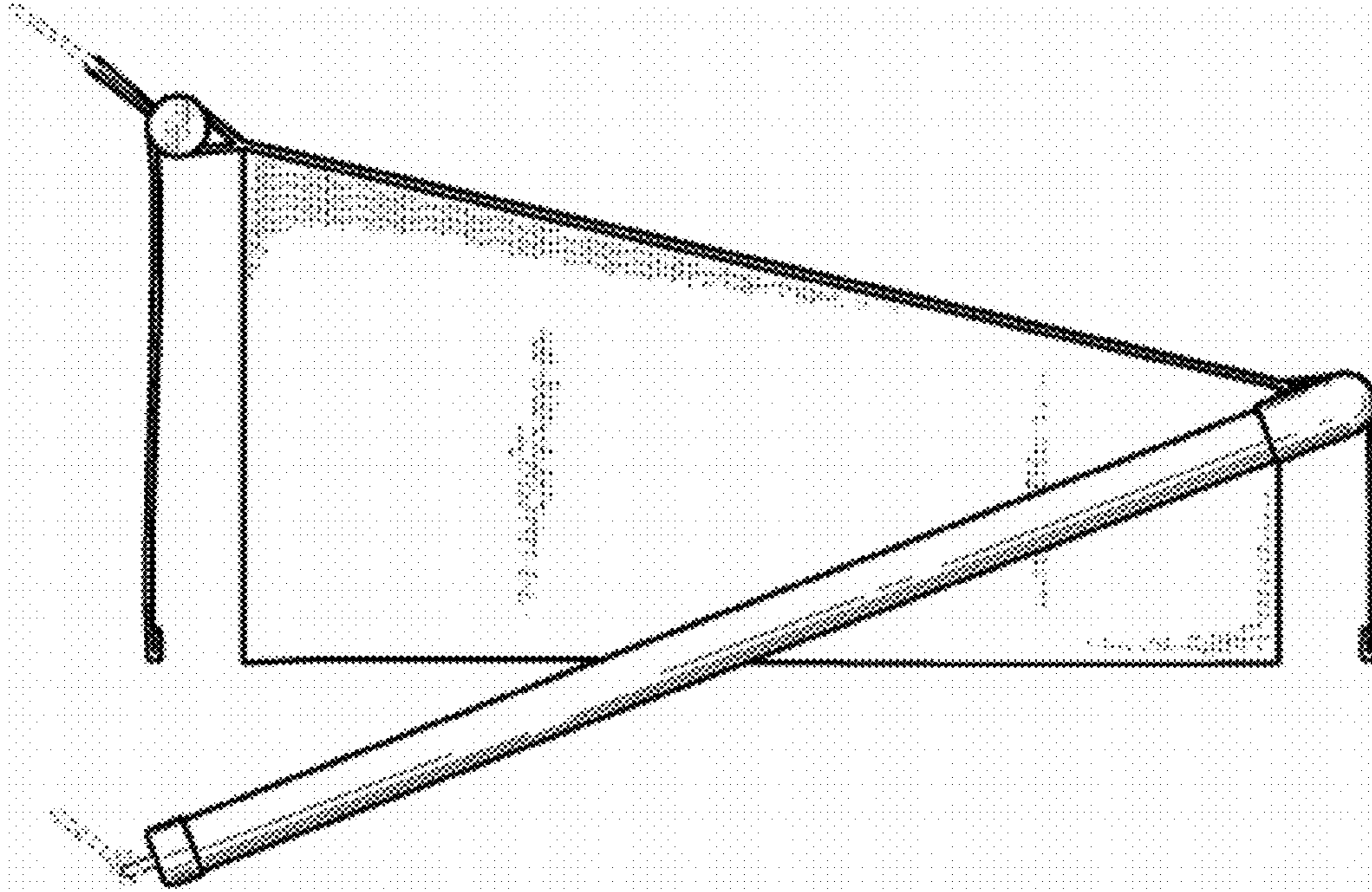

FIG. 2

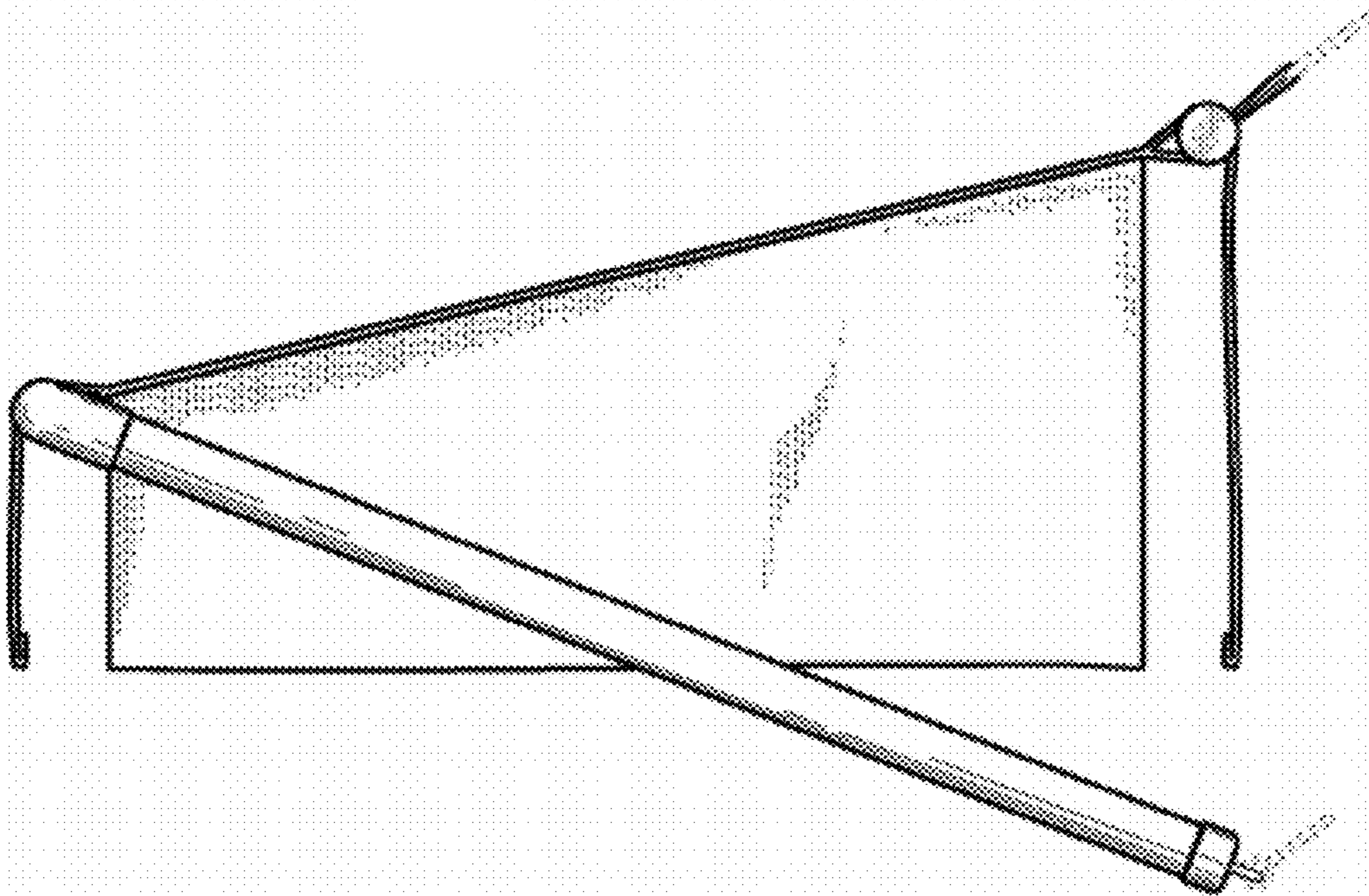

FIG. 3

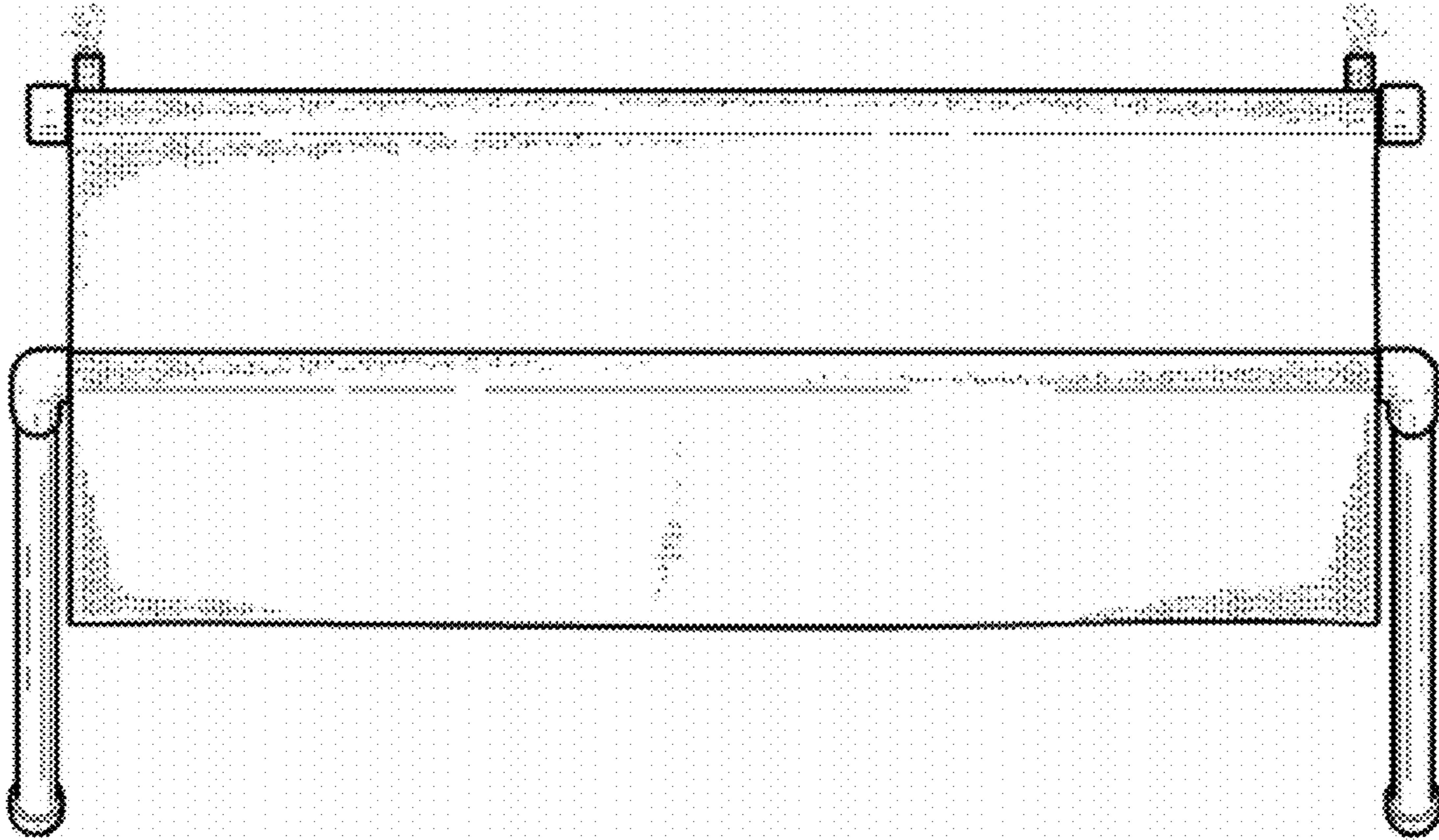

FIG. 4

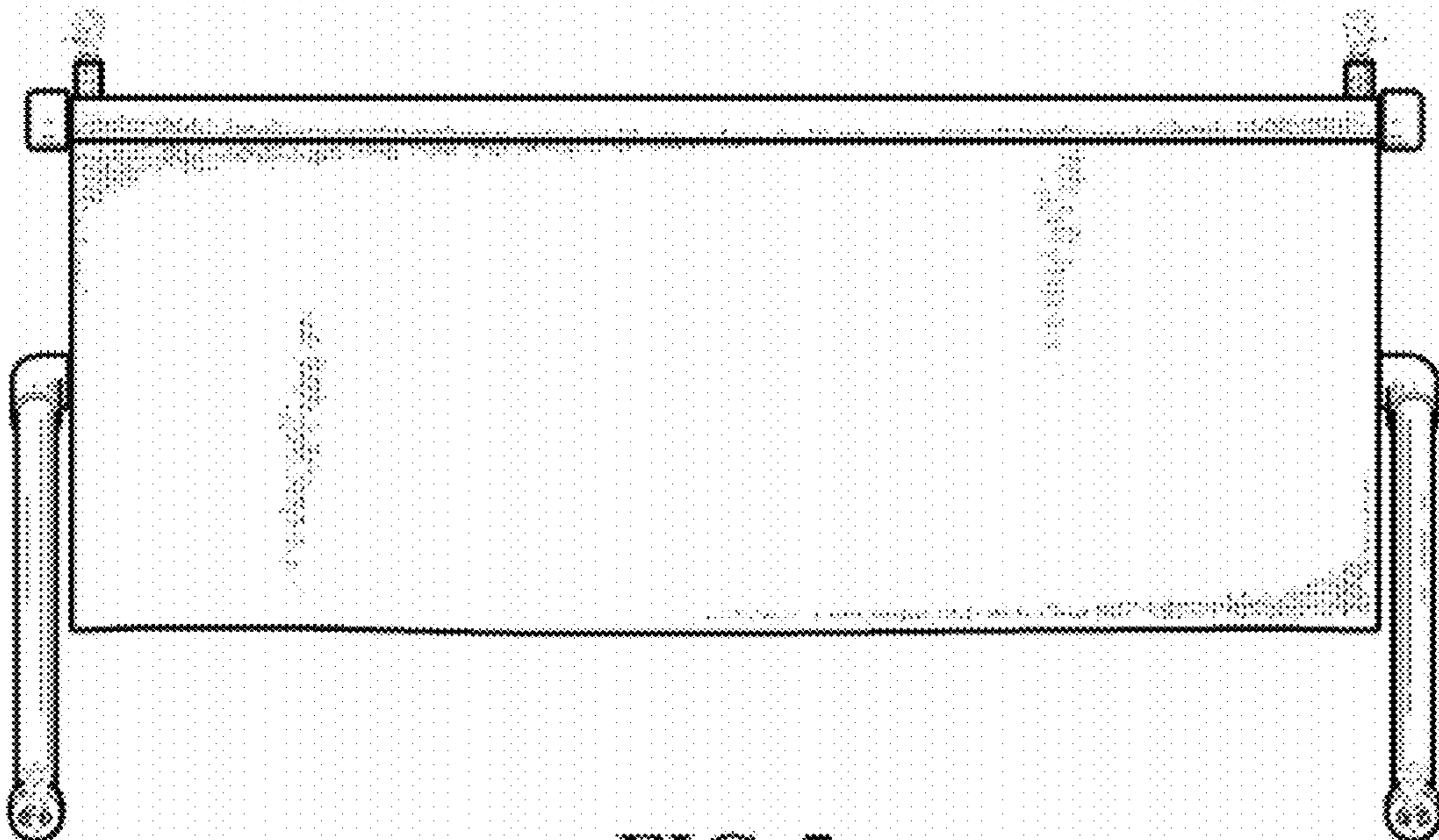

FIG. 5

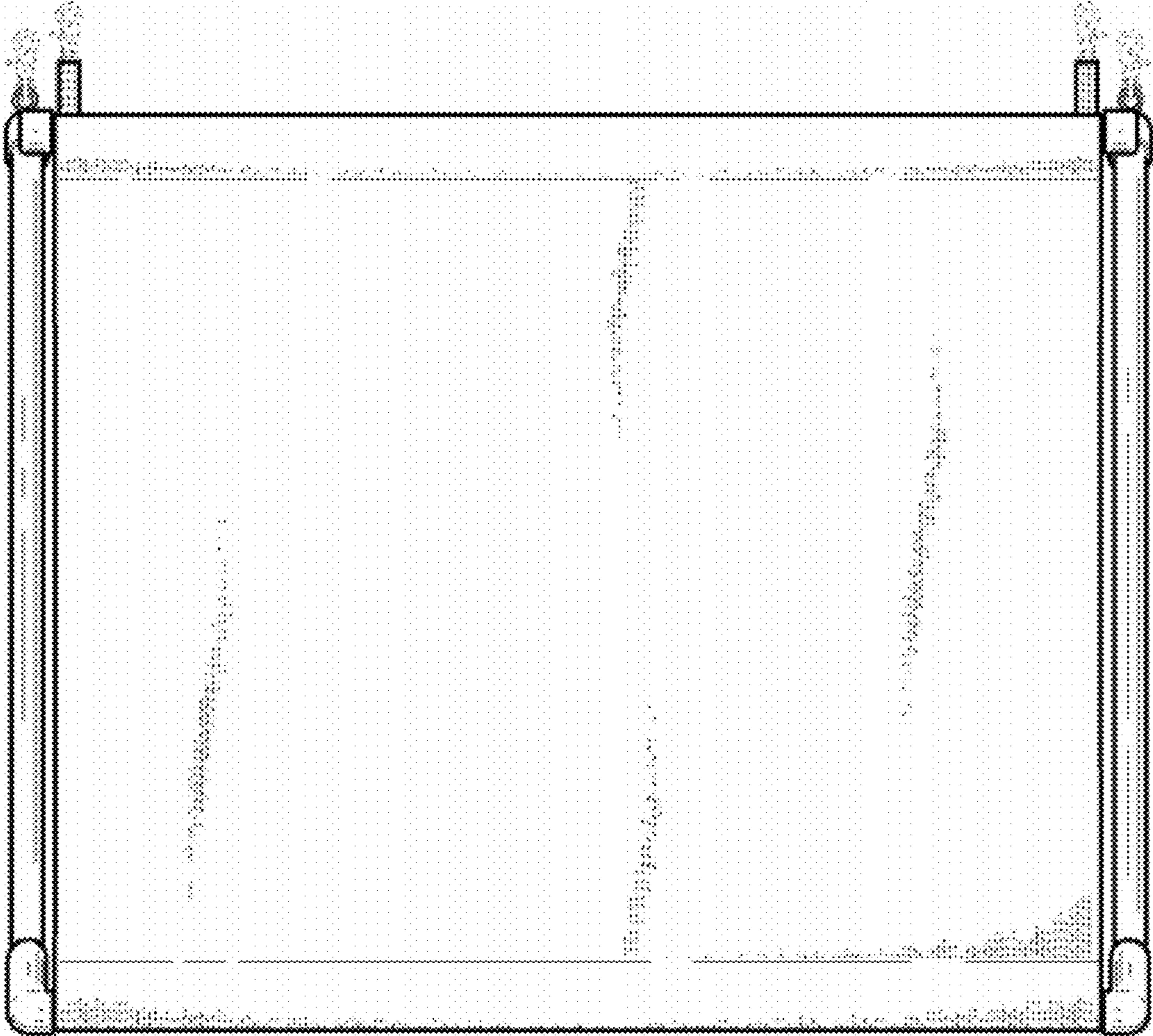

FIG. 6

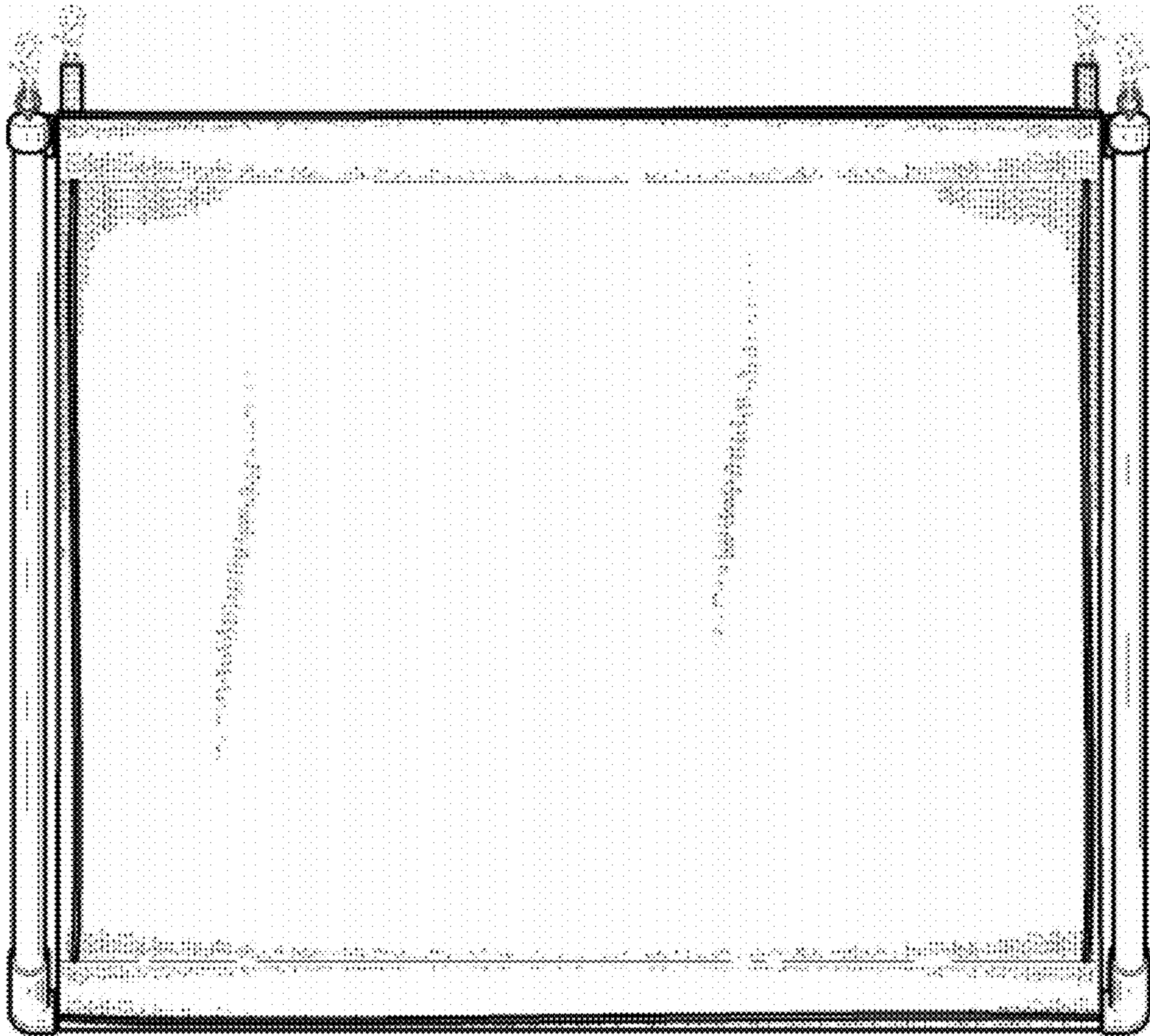

FIG. 7