



US00D664258S

(12) **United States Design Patent**
Harkin et al.

(10) **Patent No.:** **US D664,258 S**

(45) **Date of Patent:** **** Jul. 24, 2012**

(54) **DIAGNOSTIC DEVICE**

(75) Inventors: **Thomas Harkin**, Bristol (GB);
Christopher Kilbane, Bristol (GB);
Sebastian Liedtke, Heidelberg (DE)

(73) Assignee: **Roche Diagnostics Operations, Inc.**,
Indianapolis, IN (US)

(**) Term: **14 Years**

(21) Appl. No.: **29/410,473**

(22) Filed: **Jan. 9, 2012**

(30) **Foreign Application Priority Data**

Jul. 15, 2011	(EM)	001285605-0001
Jul. 15, 2011	(EM)	001285605-0002
Jul. 15, 2011	(EM)	001285605-0003
Jul. 15, 2011	(EM)	001285605-0004

(51) **LOC (9) Cl.** **24-01**

(52) **U.S. Cl.** **D24/186; D24/169**

(58) **Field of Classification Search** D24/169,
D24/186, 133, 146, 200, 158; D10/81; 600/309,
600/316, 322, 365, 368; 422/56, 63, 65,
422/102, 104

See application file for complete search history.

(56) **References Cited**

U.S. PATENT DOCUMENTS

D461,895 S *	8/2002	Barnes et al.	D24/158
D493,532 S *	7/2004	Levaughn et al.	D24/147
D505,726 S *	5/2005	Ryan	D24/200
D530,424 S *	10/2006	Manser et al.	D10/81
D544,605 S *	6/2007	Gumisawa et al.	D24/186
D549,830 S *	8/2007	Behar et al.	D24/186

(Continued)

Primary Examiner — T. Chase Nelson

Assistant Examiner — Mark Cavanna

(74) *Attorney, Agent, or Firm* — Bose McKinney & Evans LLP

(57) **CLAIM**

The ornamental design for a diagnostic device, as shown and described.

DESCRIPTION

FIG. 1 is a first perspective view of the diagnostic device that illustrates the novel design;

FIG. 2 is a second perspective view of the diagnostic device of FIG. 1;

FIG. 3 is a top view of the diagnostic device of FIG. 1;

FIG. 4 is a left view of the diagnostic device of FIG. 1;

FIG. 5 is a right view of the diagnostic device of FIG. 1;

FIG. 6 is a front view of the diagnostic device of FIG. 1;

FIG. 7 is a rear view of the diagnostic device of FIG. 1;

FIG. 8 is a bottom view of the diagnostic device of FIG. 1;

FIG. 9 is a bottom perspective view of the diagnostic device of FIG. 1;

FIG. 10 is a first perspective view of the diagnostic device of FIG. 1 without the removable lancing device;

FIG. 11 is a second perspective view of the diagnostic device of FIG. 10;

FIG. 12 is a top view of the diagnostic device of FIG. 10;

FIG. 13 is a left view of the diagnostic device of FIG. 10;

FIG. 14 is a right view of the diagnostic device of FIG. 10;

FIG. 15 is a front view of the diagnostic device of FIG. 10;

FIG. 16 is a rear view of the diagnostic device of FIG. 10;

FIG. 17 is a bottom view of the diagnostic device of FIG. 10; and,

FIG. 18 is a bottom perspective view of the diagnostic device of FIG. 10.

1 Claim, 14 Drawing Sheets

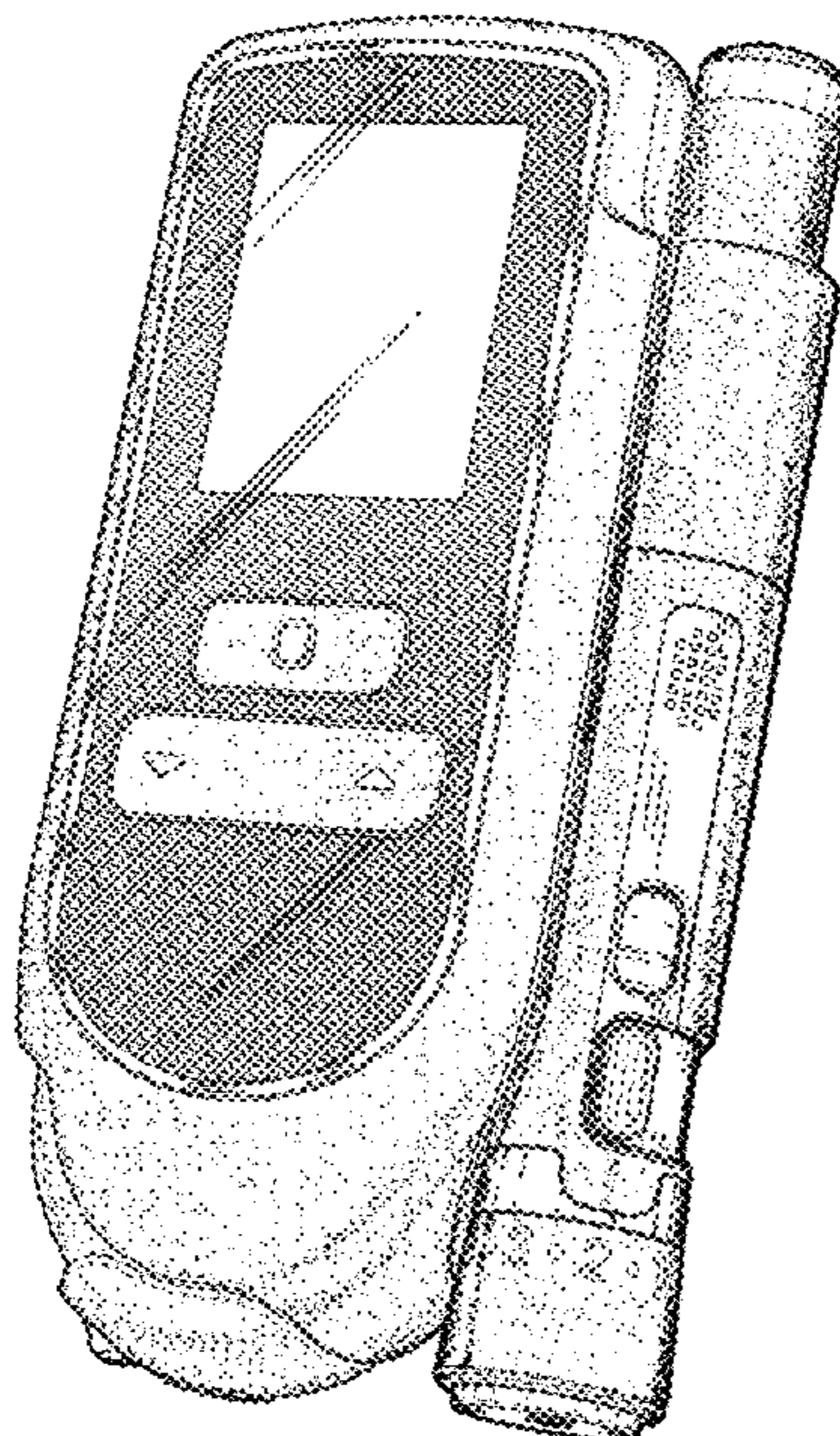

US D664,258 S

Page 2

U.S. PATENT DOCUMENTS

D550,363 S *	9/2007	Hannant et al.	D24/186	D629,522 S *	12/2010	Moscovita et al.	D24/169
D566,273 S *	4/2008	Gutmann et al.	D24/146	D634,432 S	3/2011	Liedtke et al.	
D569,982 S *	5/2008	Loerwald	D24/186	D634,435 S *	3/2011	Chua et al.	D24/186
D600,349 S *	9/2009	Bell et al.	D24/169	D637,287 S *	5/2011	Mudd et al.	D24/133
D610,688 S *	2/2010	Donars et al.	D24/169	D648,024 S *	11/2011	Harkin et al.	D24/146

* cited by examiner

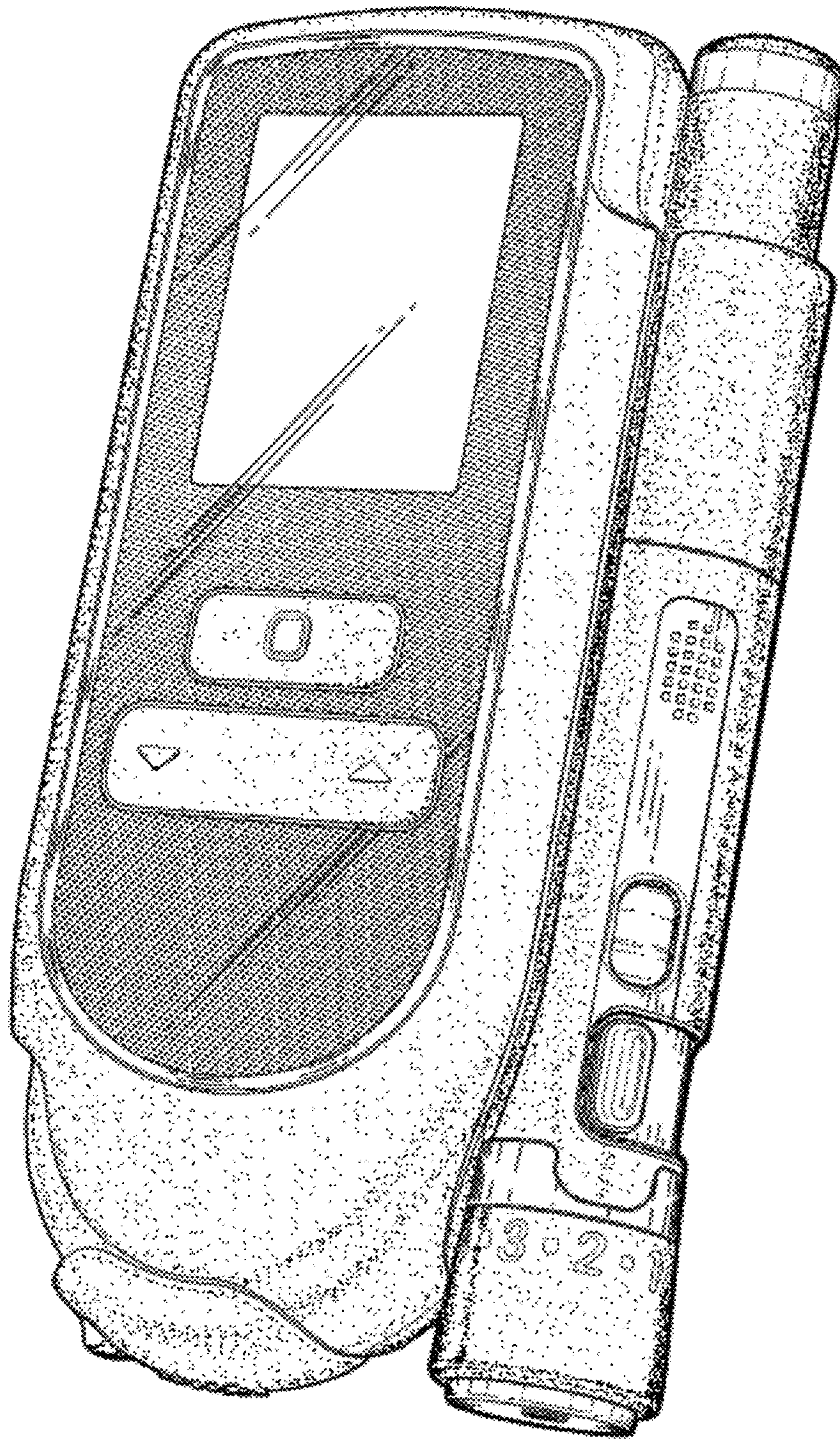

Fig. 1

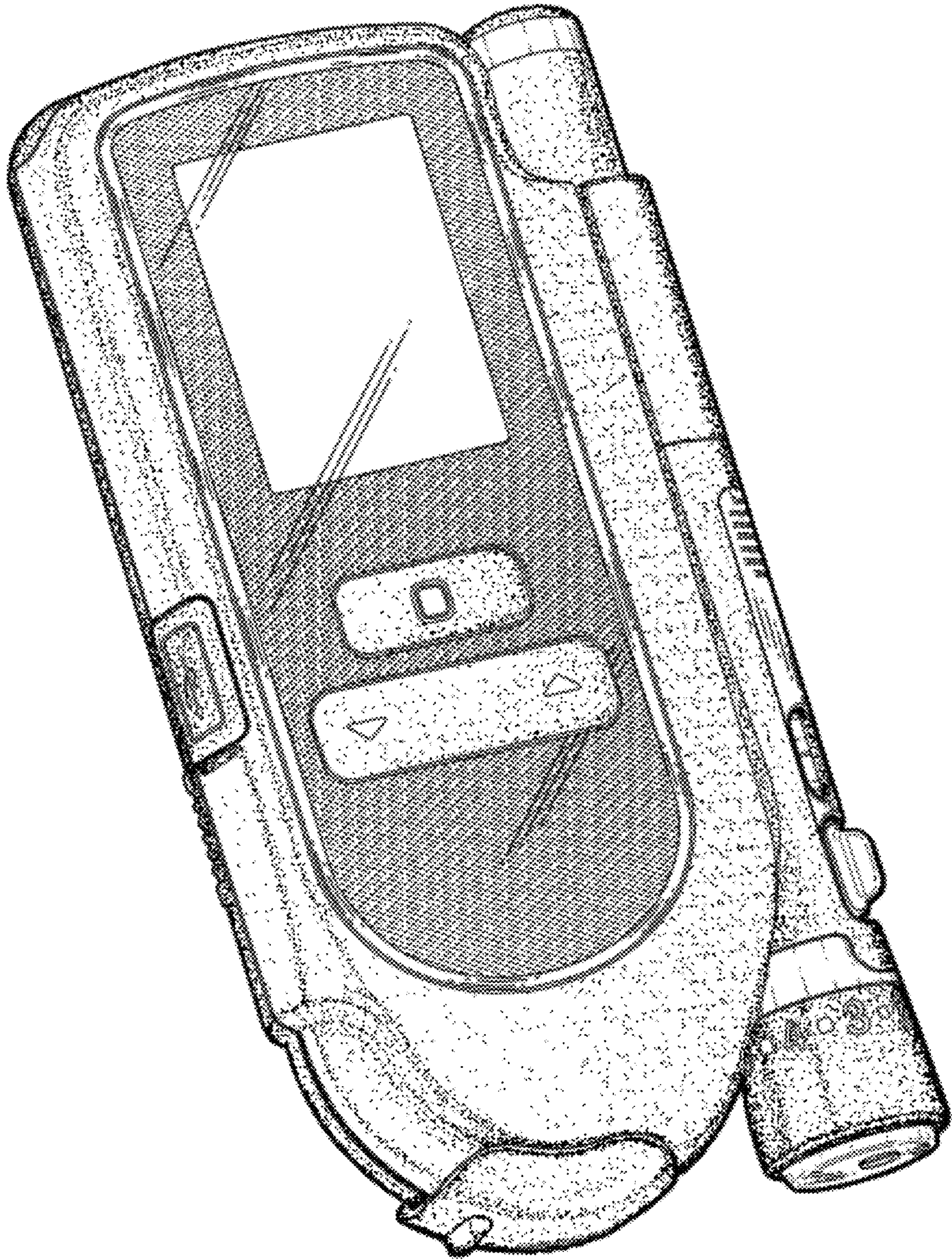

Fig. 2

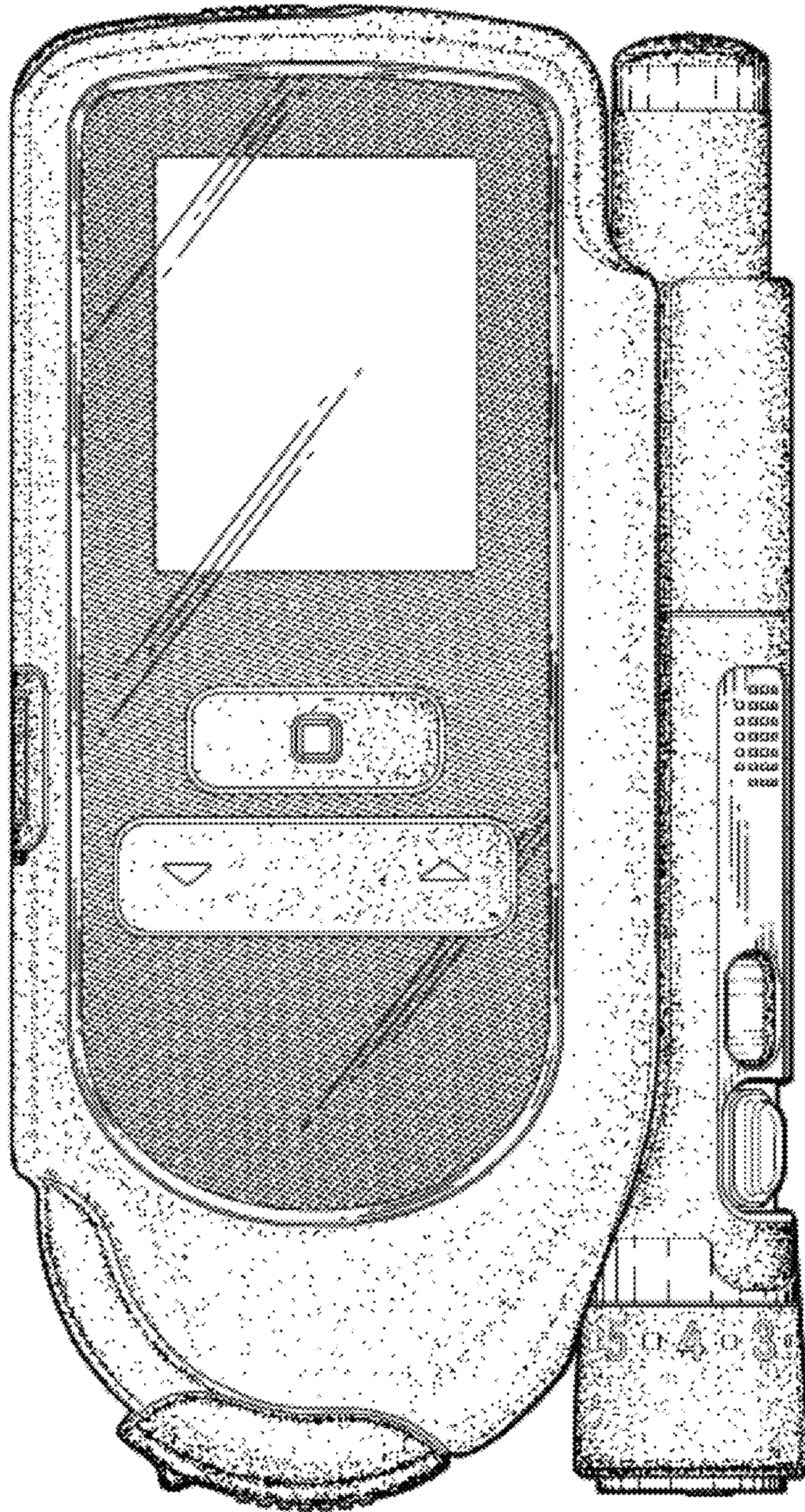

Fig. 3

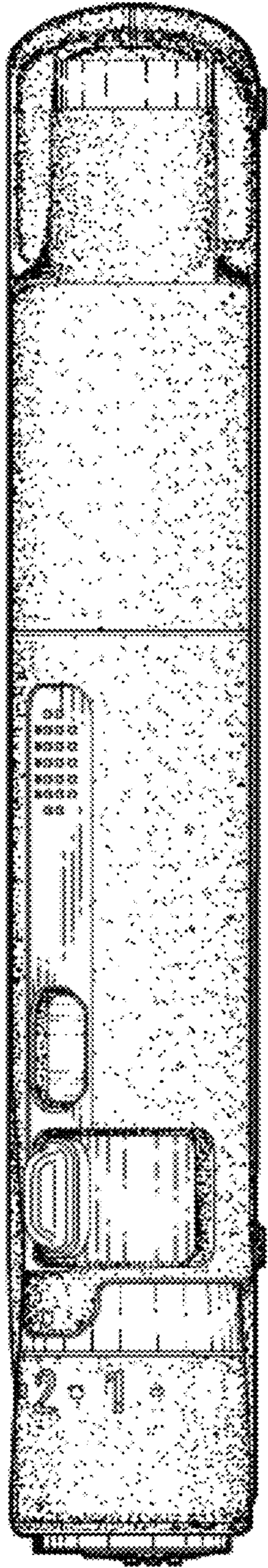

Fig. 4

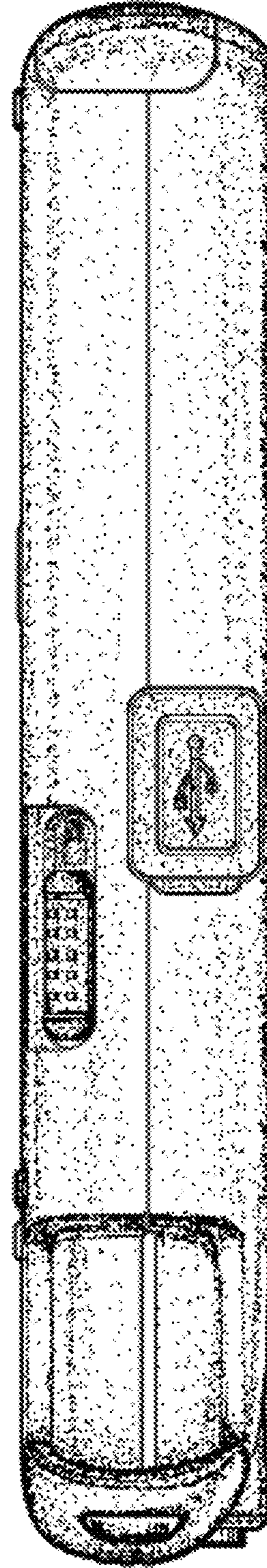

Fig. 5

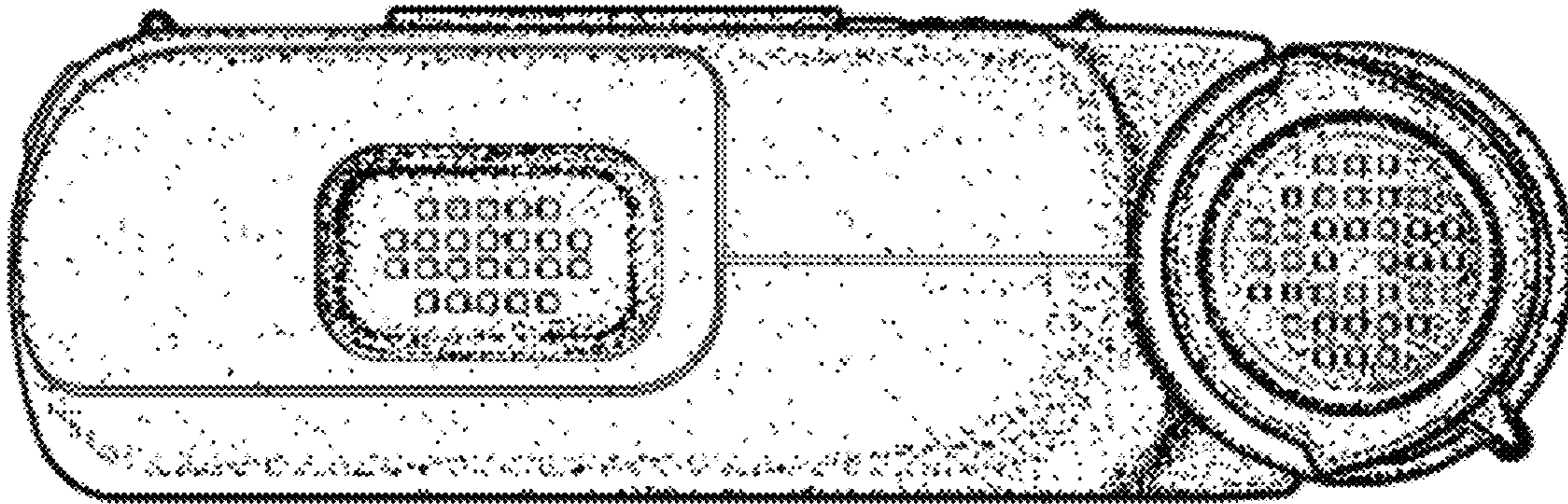

Fig. 7

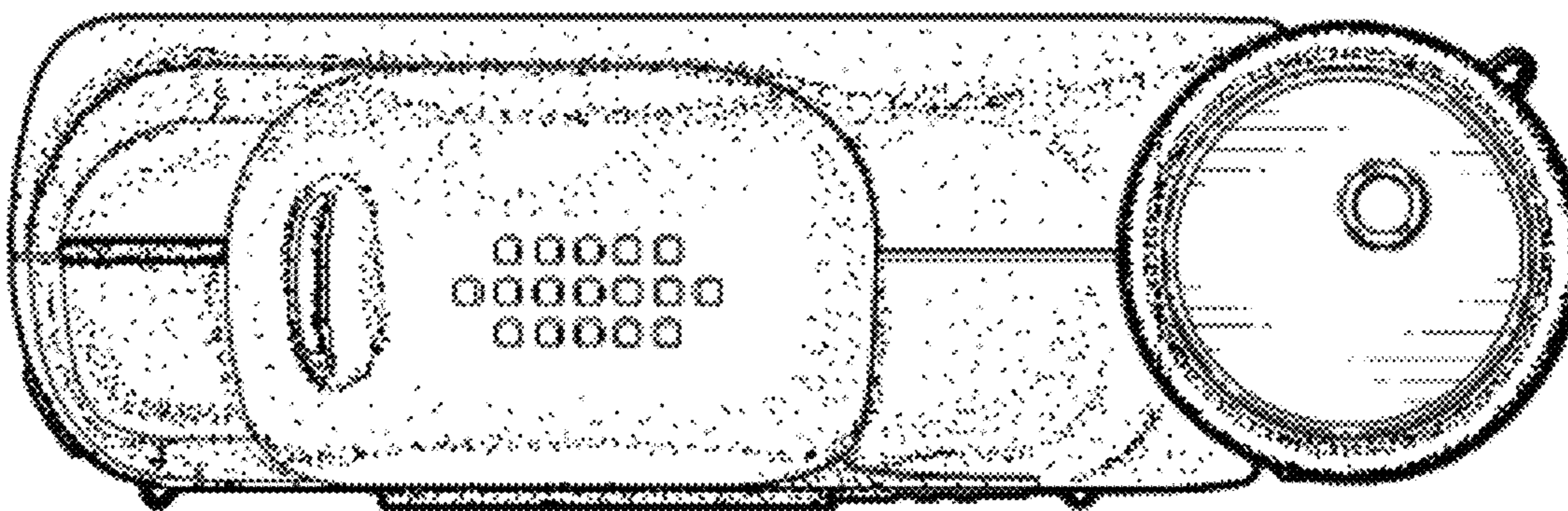

Fig. 6

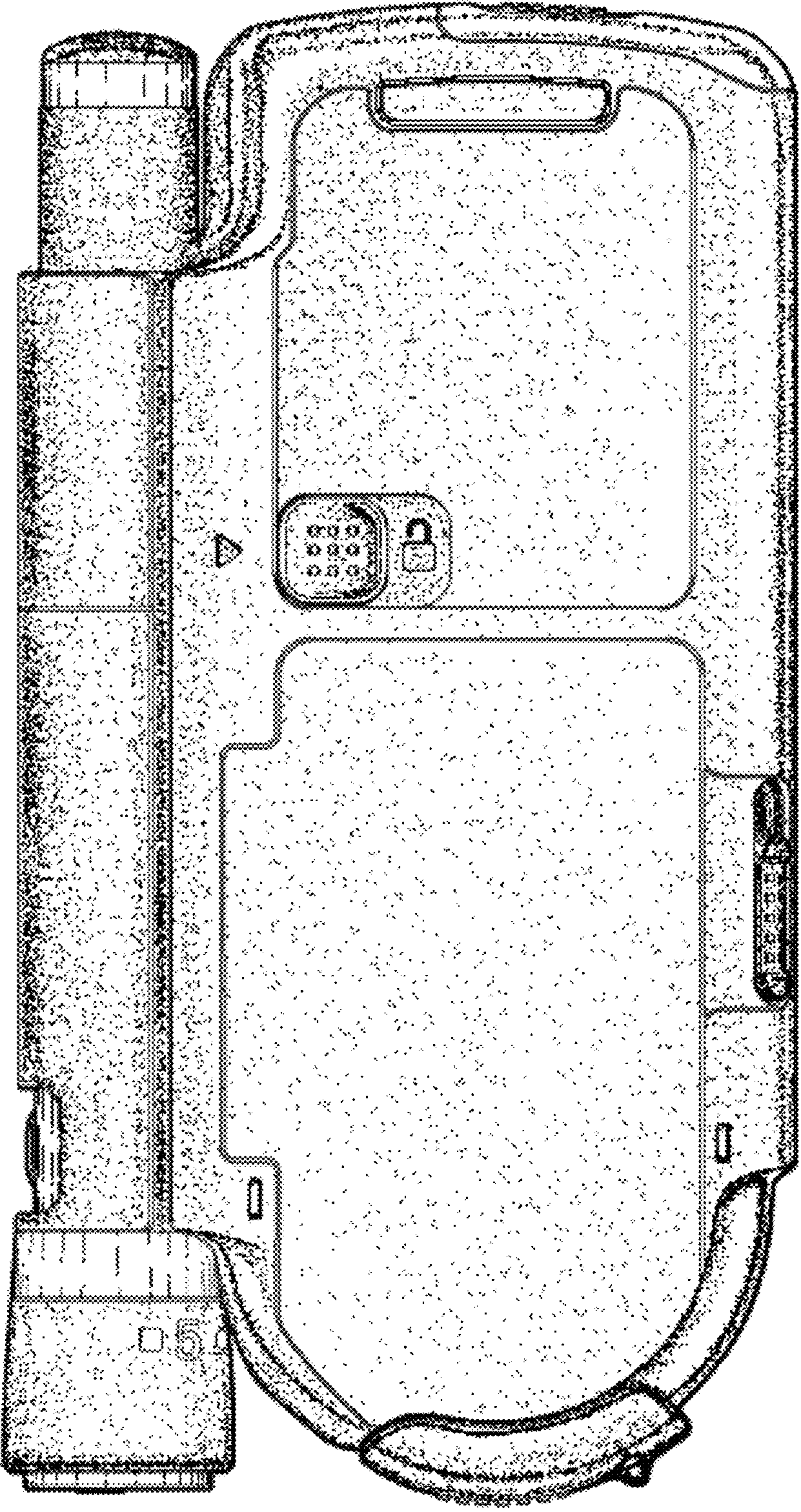

Fig. 8

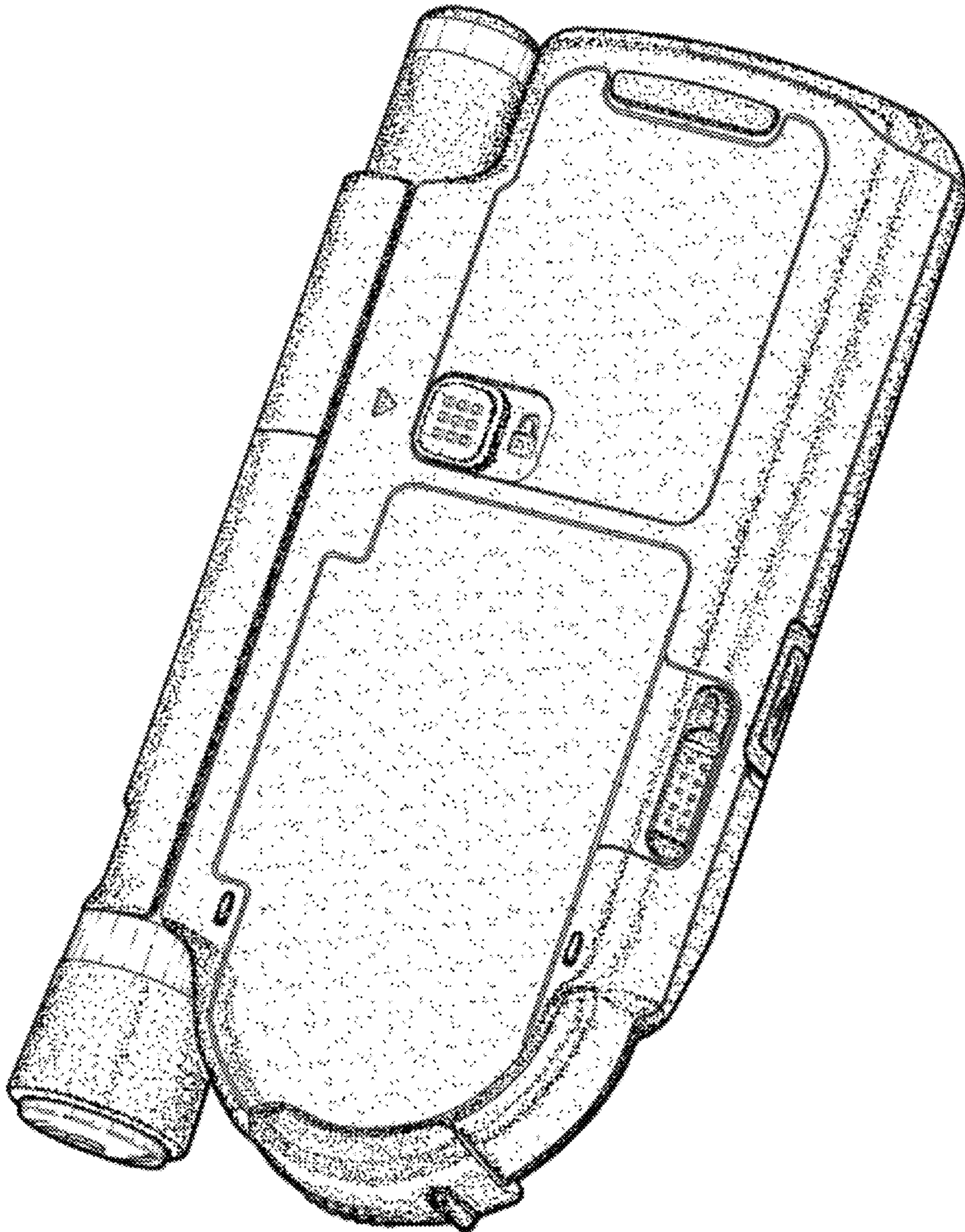

Fig. 9

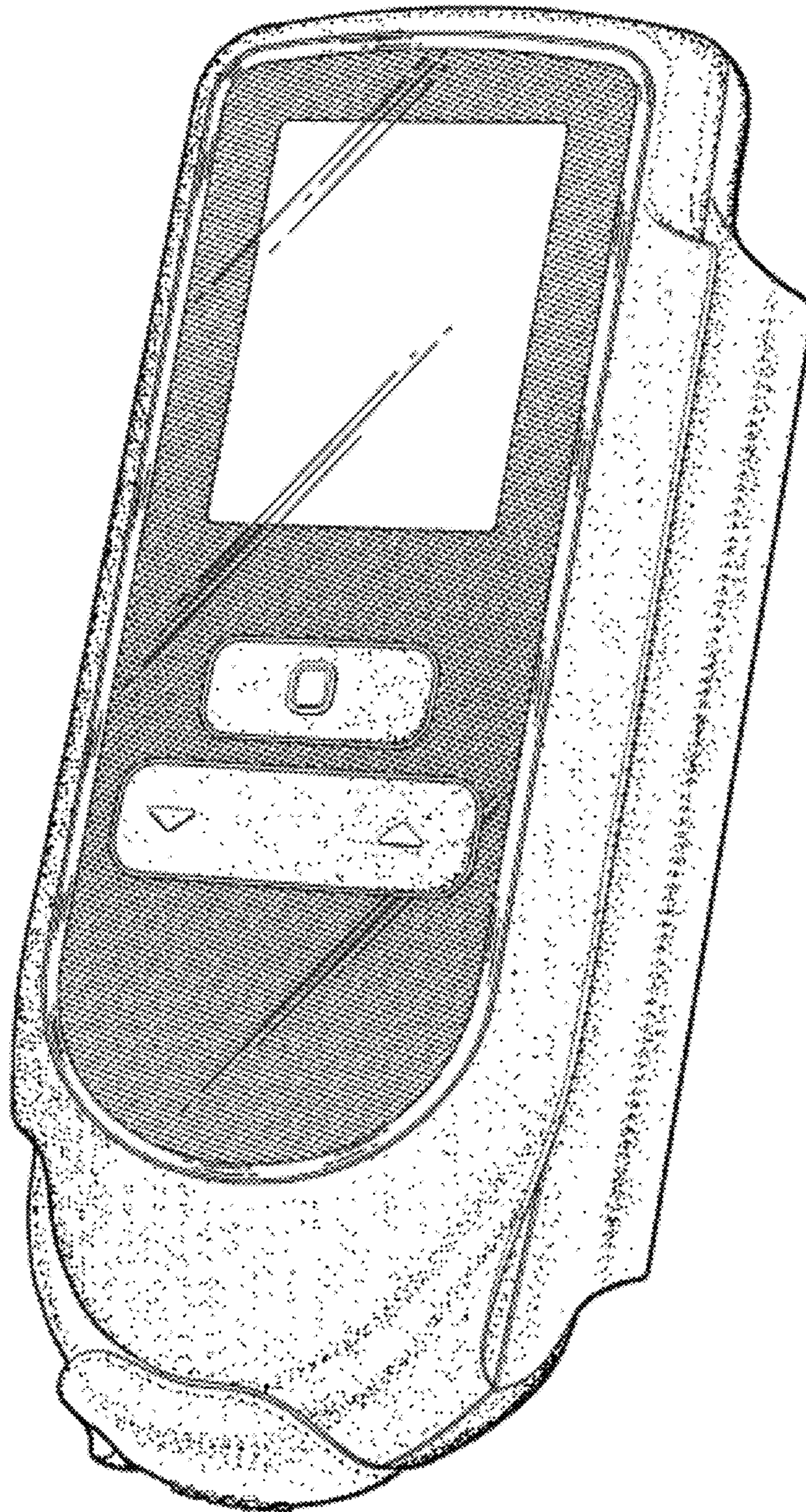

Fig. 10

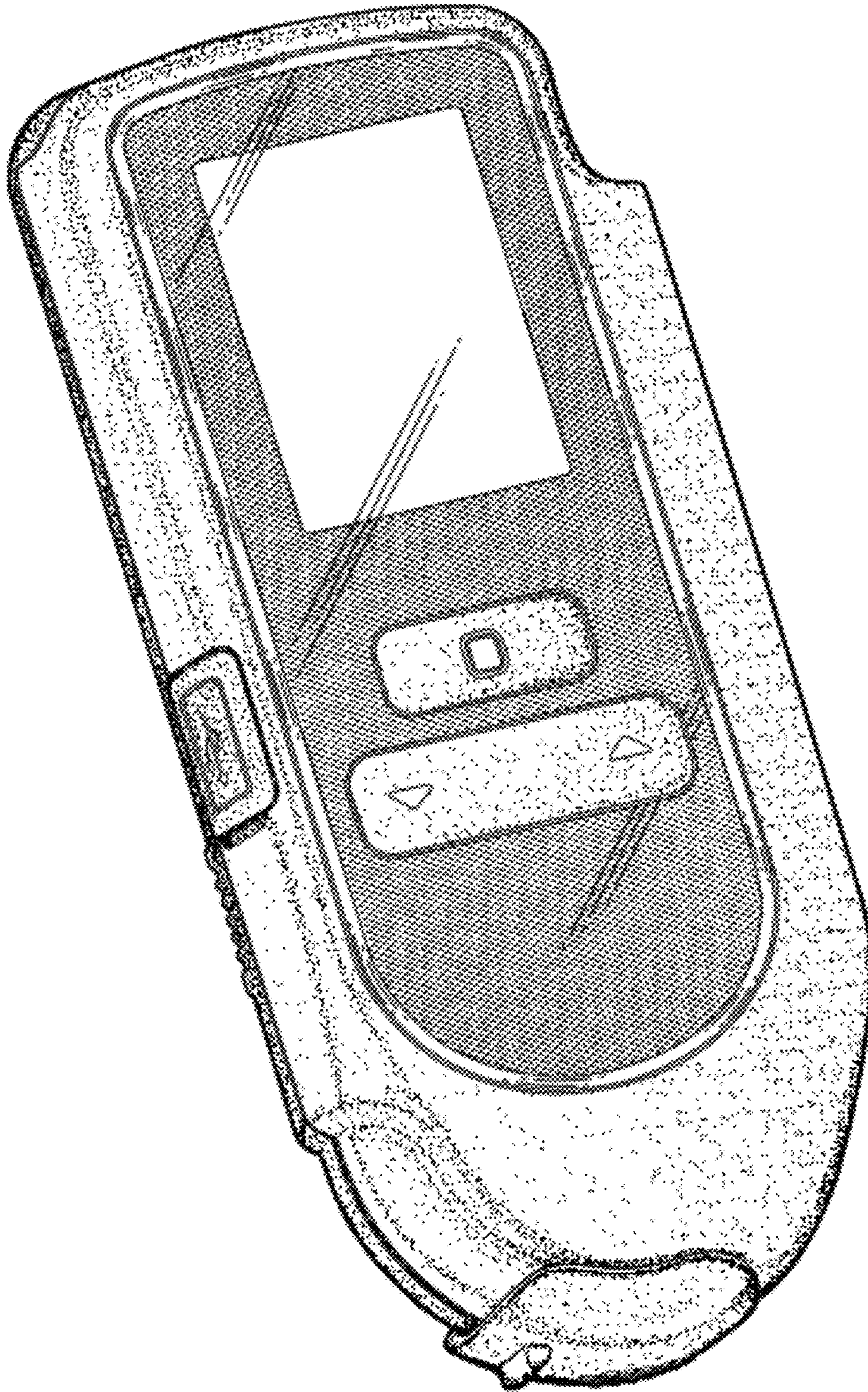

Fig. 11

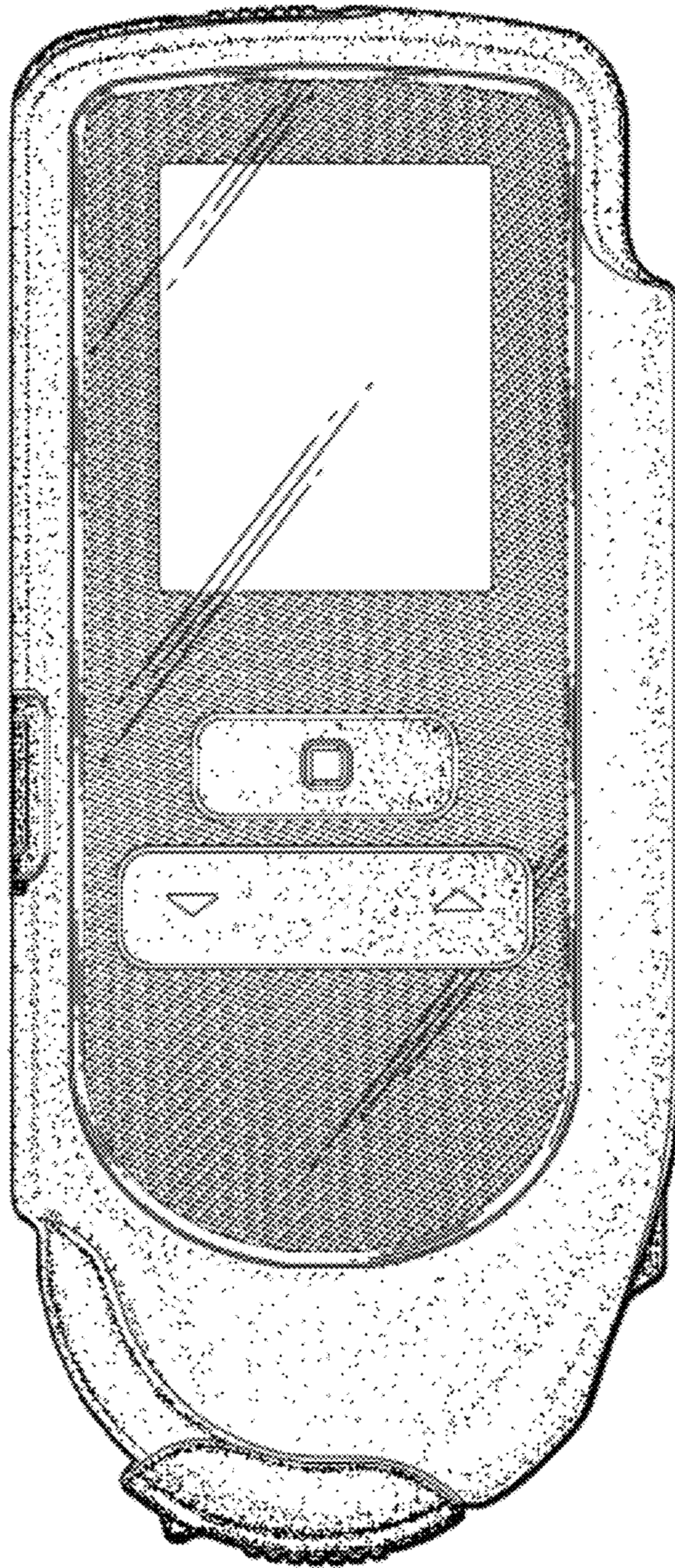

Fig. 12

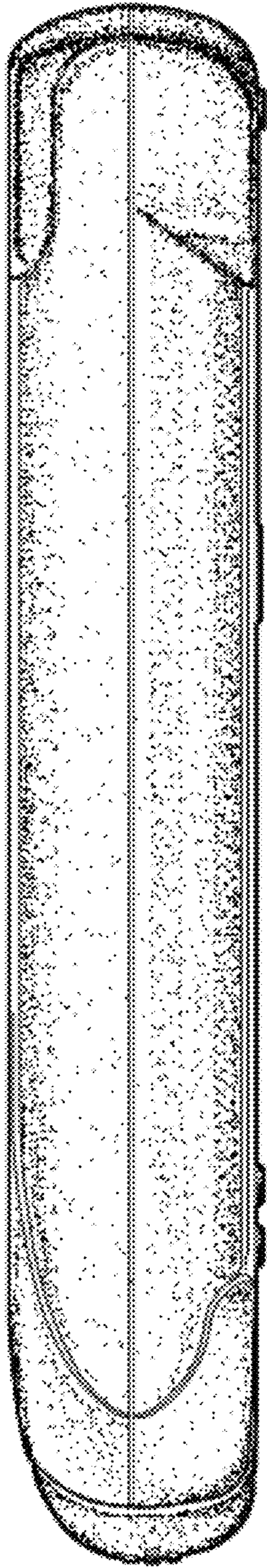

Fig. 13

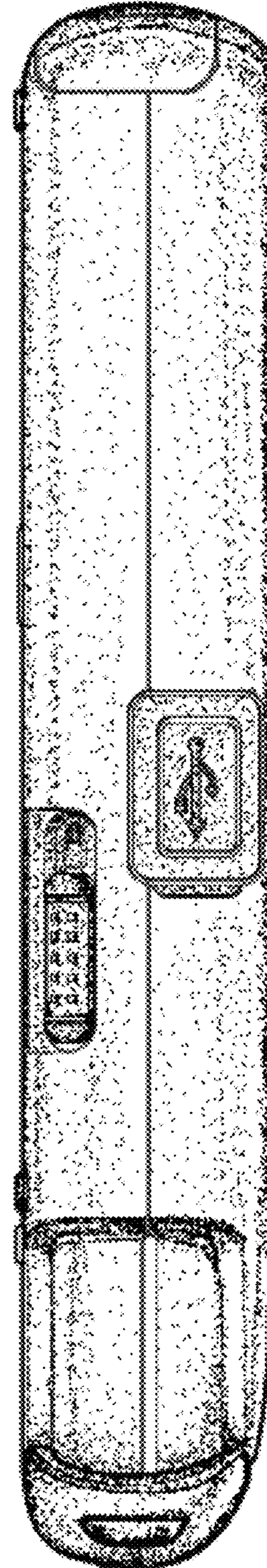

Fig. 14

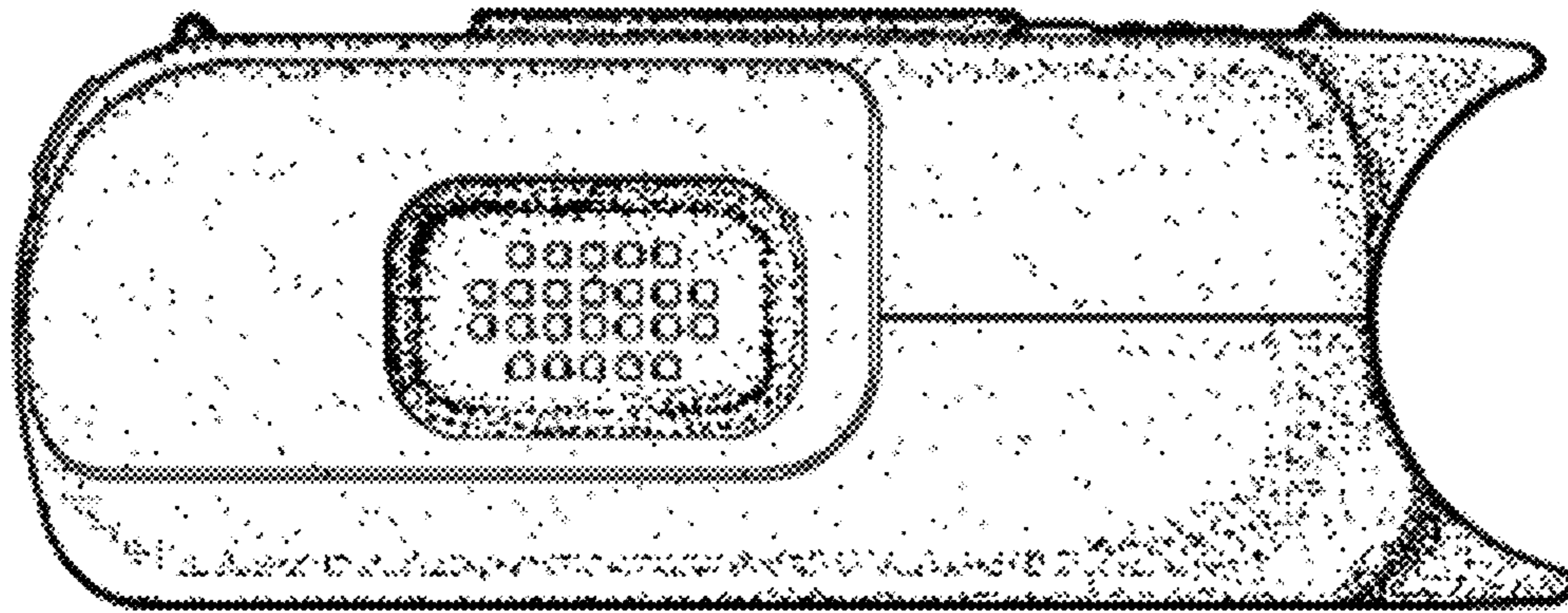

Fig. 16

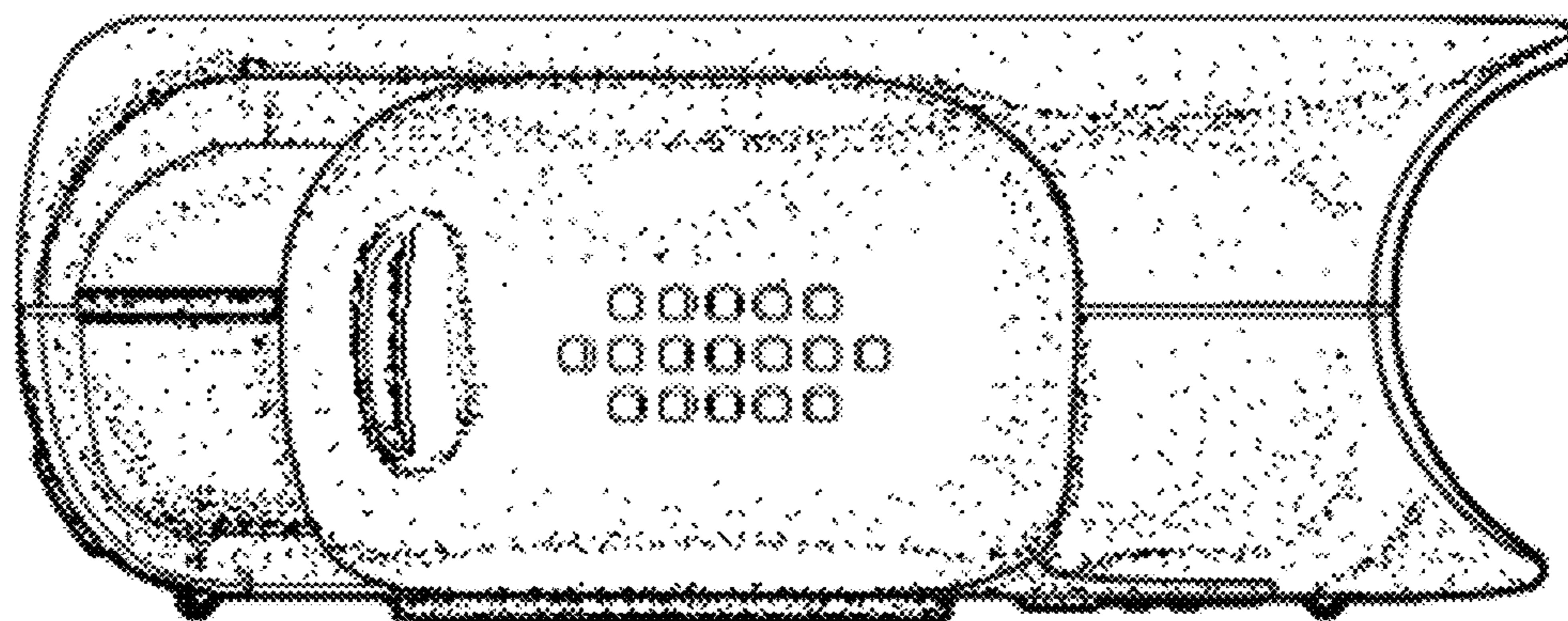

Fig. 15

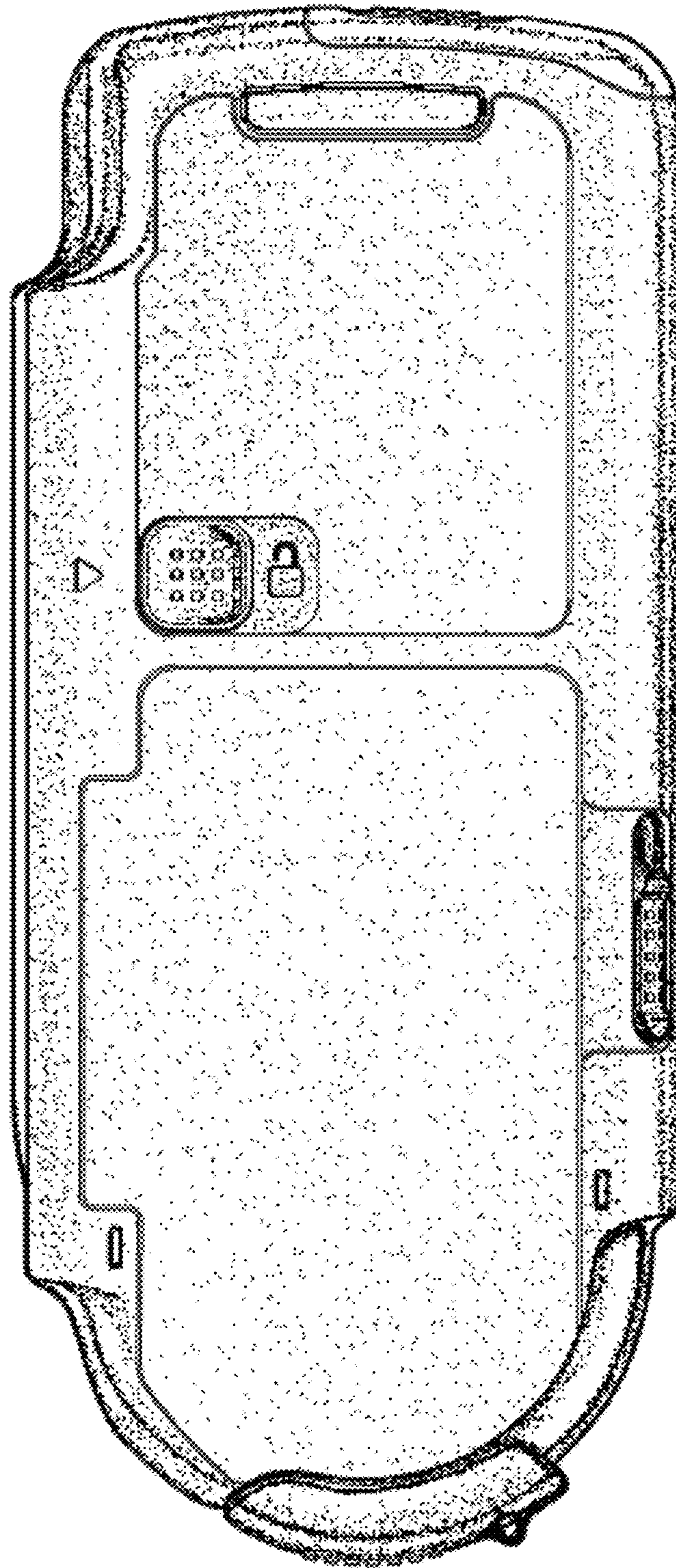

Fig. 17

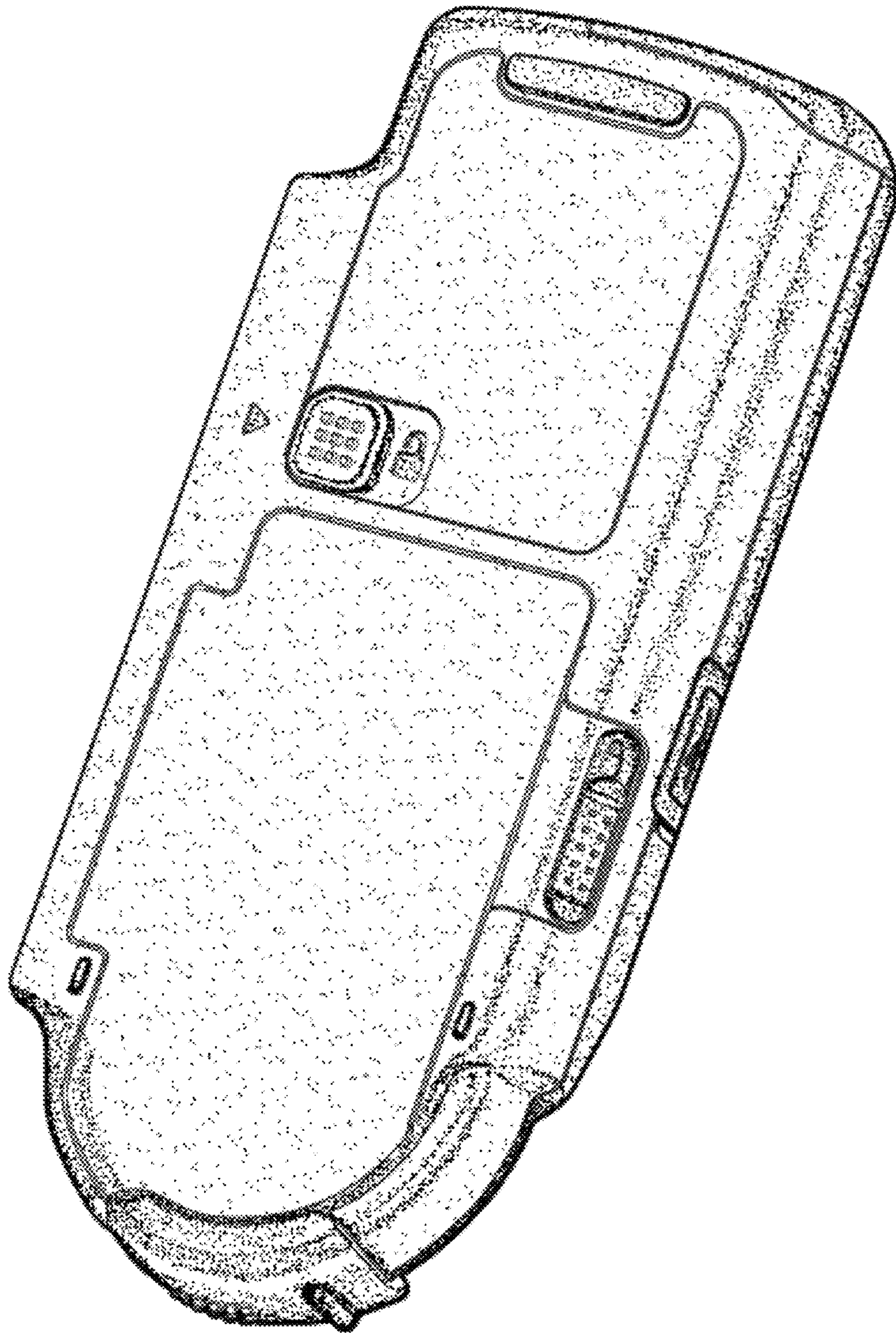

Fig. 18