



US00D664210S

(12) **United States Design Patent**
Bengyak

(10) **Patent No.:** **US D664,210 S**
(45) **Date of Patent:** **** Jul. 24, 2012**

(54) **HAND SIGN**

DESCRIPTION

(76) Inventor: **Christopher Edward Bengyak**, Vero Beach, FL (US)
(**) Term: **14 Years**
(21) Appl. No.: **29/374,206**
(22) Filed: **Jul. 14, 2011**
(51) **LOC (9) Cl.** **20-03**
(52) **U.S. Cl.** **D20/36; D20/33**
(58) **Field of Classification Search** D20/10, D20/19, 29-33, 40, 99; 40/446, 538, 541, 40/584, 586; D2/615; D21/400
See application file for complete search history.

FIG. 1 is a right-side elevational view of a first embodiment of a left-hand hand sign according to the invention;
FIG. 2 is a left-side elevational view of the left-hand hand sign of FIG. 1;
FIG. 3 is a reduced scale rear elevational view of the left-hand hand sign of FIG. 1;
FIG. 4 is a reduced scale top plan view of the left-hand hand sign of FIG. 1;
FIG. 5 is a reduced scale bottom plan view of the left-hand hand sign of FIG. 1;
FIG. 6 is a reduced scale front plan view of the left-hand hand sign of FIG. 1;
FIG. 7 is a perspective view from below the rear of the right side of the left-hand hand sign of FIG. 1;
FIG. 8 is a perspective view from above the front of the right side of the left-hand hand sign of FIG. 1.
FIG. 9 is a left-side elevational view of a second embodiment of a right-hand hand sign according to the invention;
FIG. 10 is a right-side elevational view of the right-hand hand sign of FIG. 9;
FIG. 11 is a reduced scale front elevational view of the right-hand hand sign of FIG. 9;
FIG. 12 is a reduced scale top plan view of the right-hand hand sign of FIG. 9;
FIG. 13 is a reduced scale bottom plan view of the right-hand hand sign of FIG. 9;
FIG. 14 is a reduced scale rear elevational view of the right-hand hand sign of FIG. 9;
FIG. 15 is a perspective view from below the rear of the left side of the right-hand hand sign of FIG. 9; and,
FIG. 16 is a perspective view from above the front of the left side of the right-hand hand sign of FIG. 9.
The "Star" logo is a registered trademark owned/registered by the Dallas Cowboys Football Club, Ltd. JWJ Corp. (a Texas Corporation) Limited Partnership Texas One Cowboys Parkway Irving Texas 750634727.

(56) **References Cited**

U.S. PATENT DOCUMENTS

D164,567 S *	9/1951	Gosselin	D20/32
D360,653 S *	7/1995	McKee	D20/33
D386,530 S *	11/1997	Pesta	D20/33
D427,638 S *	7/2000	Collins et al.	D20/10
D429,285 S *	8/2000	Schini	D20/32
D555,205 S *	11/2007	Strong	D20/10
D628,651 S *	12/2010	Lake	D20/33

(Continued)

OTHER PUBLICATIONS

Star—Trademark Registration No. 2984690, Aug. 16, 2005 Dallas Cowboys Football Club, Ltd. JWJ Corp. (a Texas Corporation) Trademark Electronic Service System (TESS), at www.uspto.gov.*

Primary Examiner — Mary Ann Calabrese

(57) **CLAIM**

The ornamental design for a hand sign, as shown and described.

1 Claim, 10 Drawing Sheets

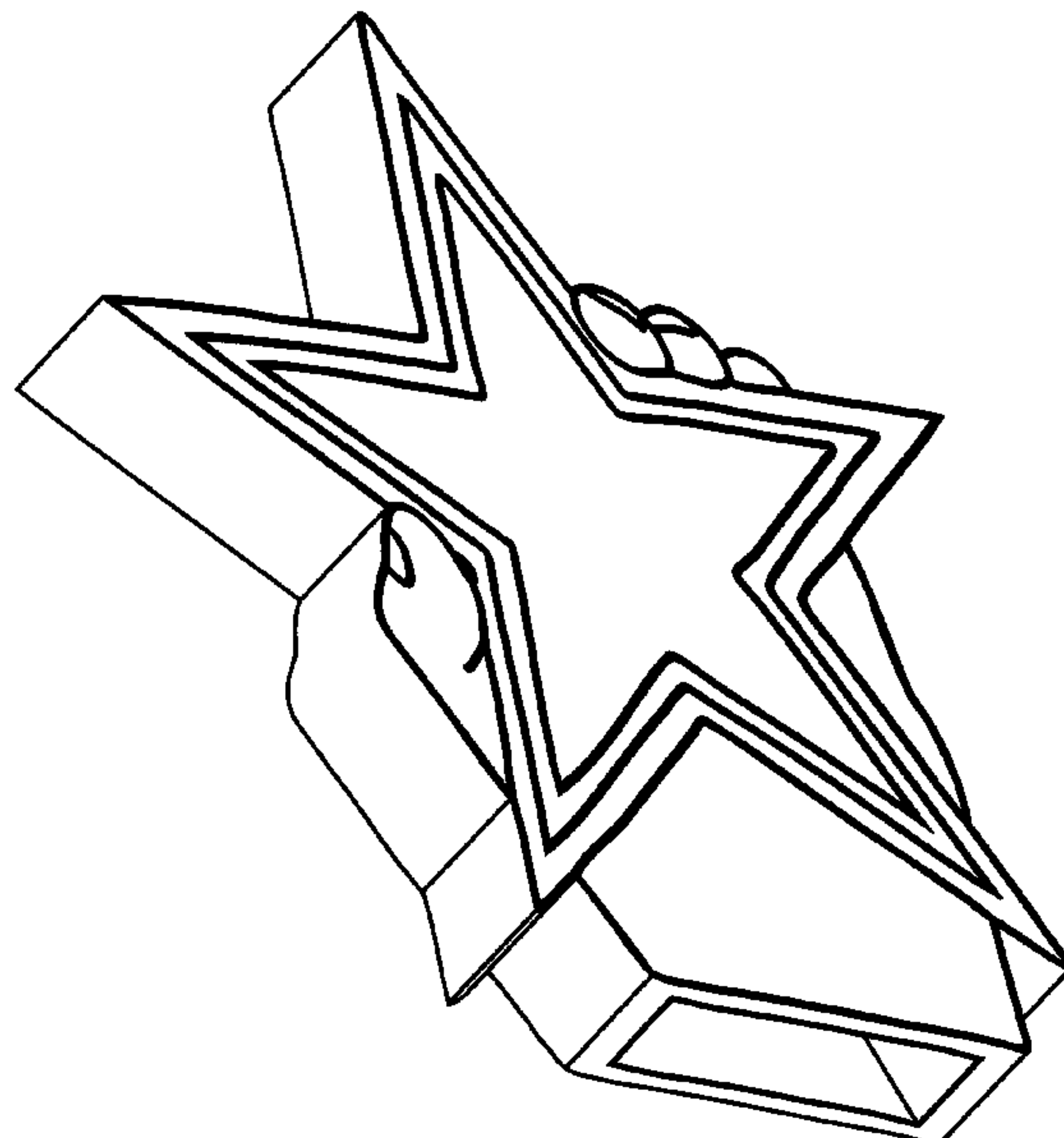

US D664,210 S

Page 2

U.S. PATENT DOCUMENTS

D633,152 S *	2/2011	Scott	D20/33	D641,424 S *	7/2011	Bengyak	D20/29
D633,945 S *	3/2011	Scott	D20/33	D641,791 S *	7/2011	Scott	D20/33
D633,946 S *	3/2011	Scott	D20/33	D647,571 S *	10/2011	Bengyak	D20/33

* cited by examiner

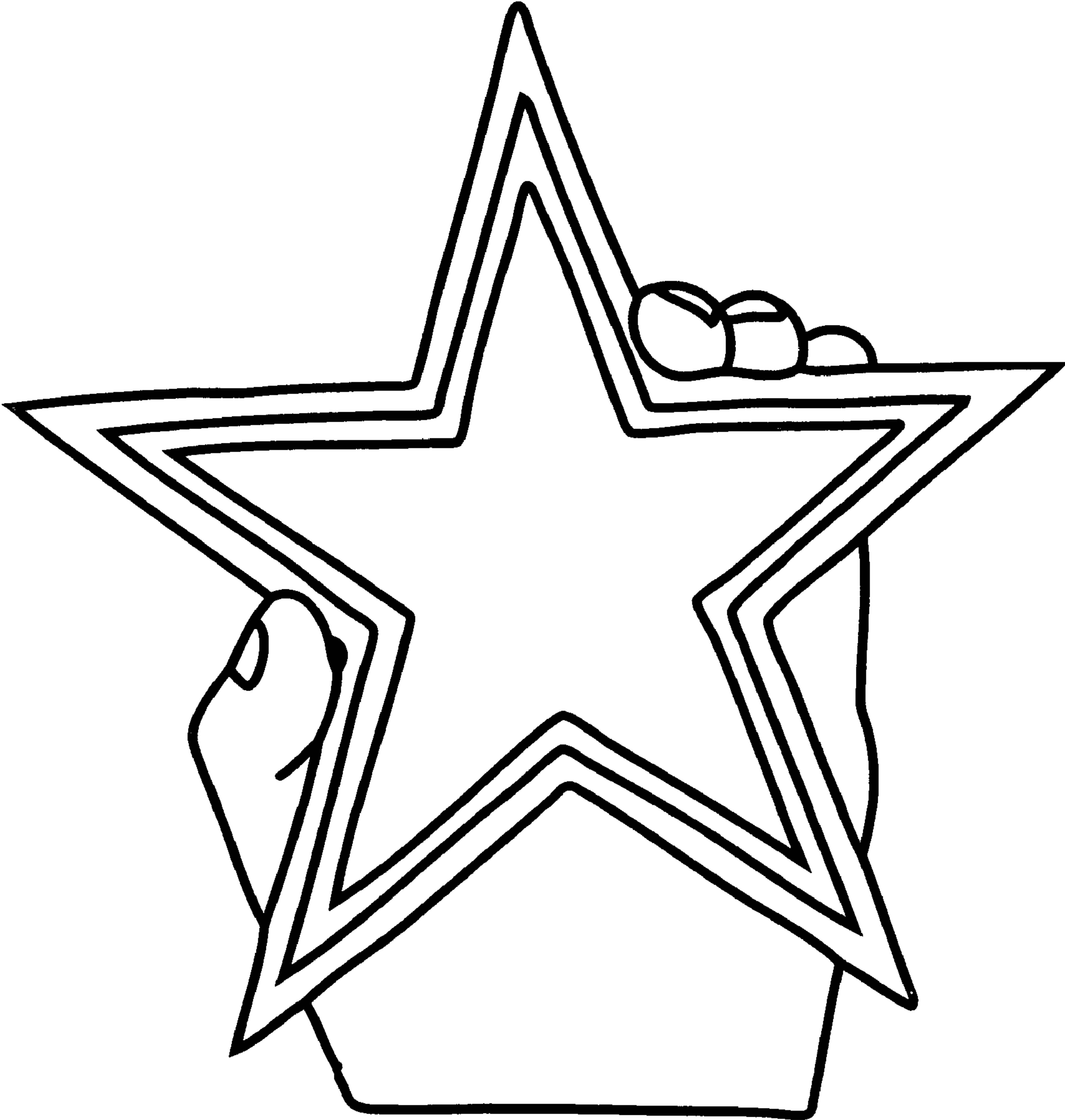

FIG. 1

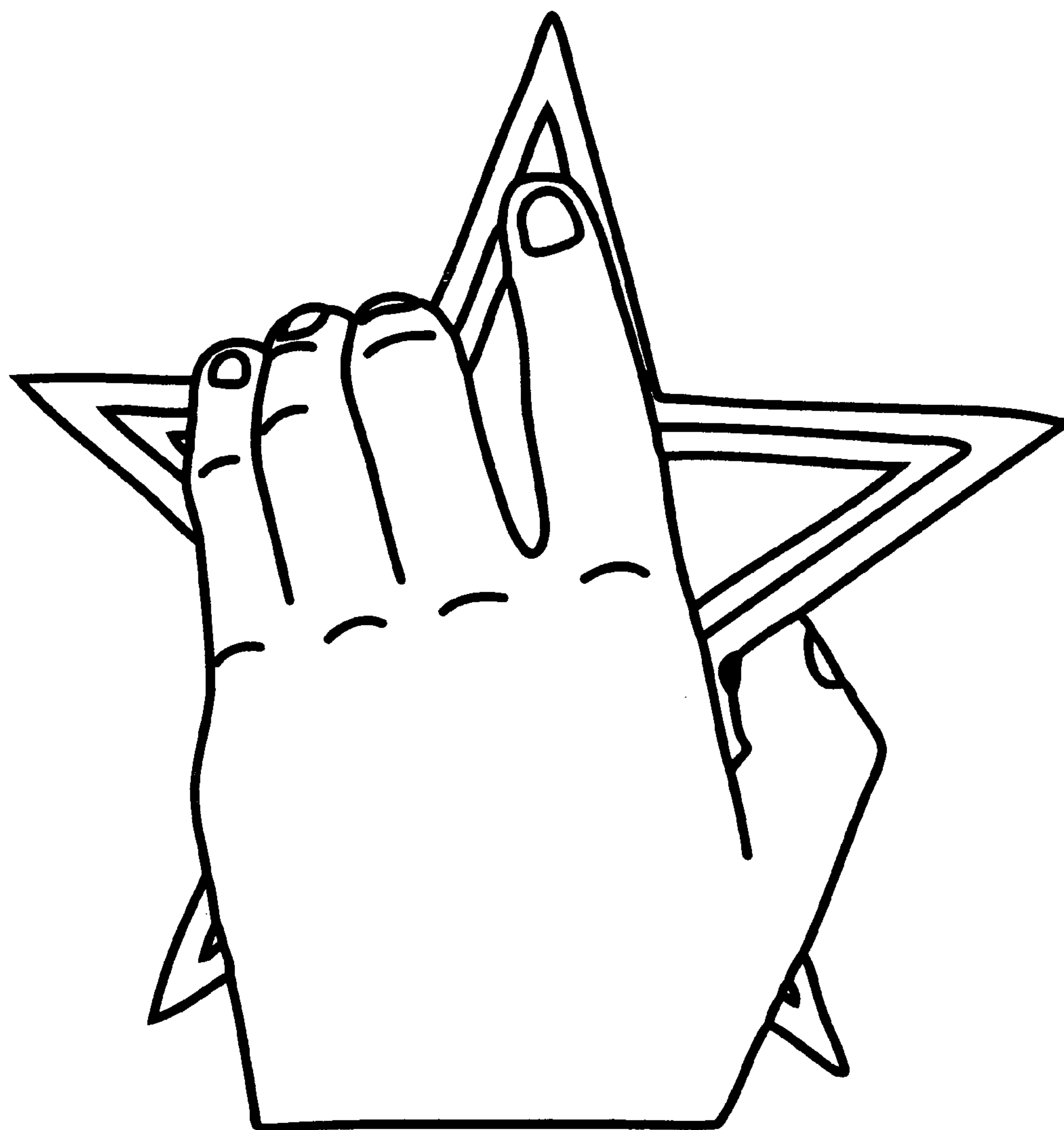

FIG. 2

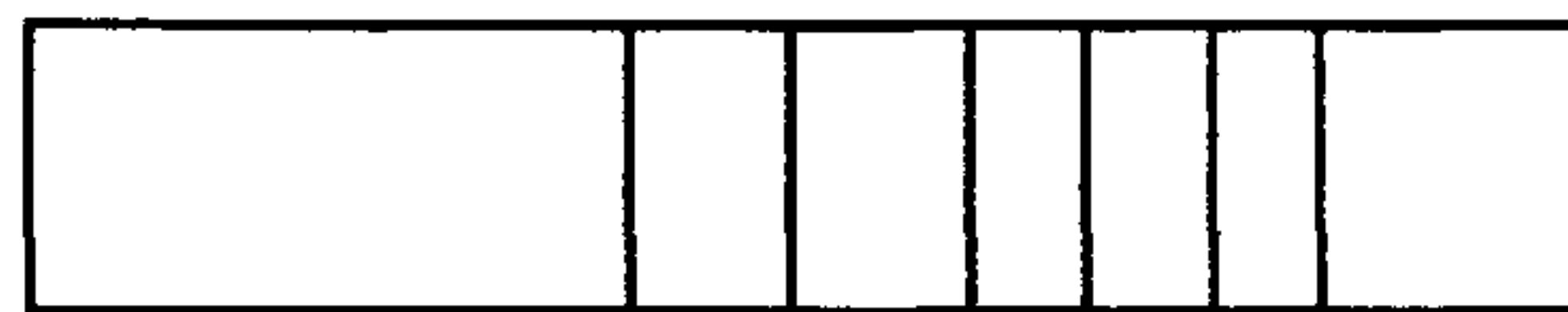

FIG. 4

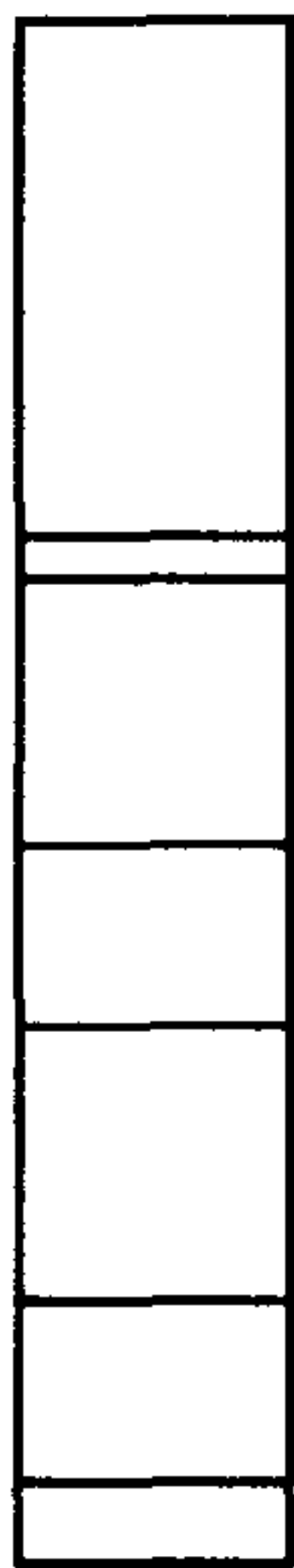

FIG. 3

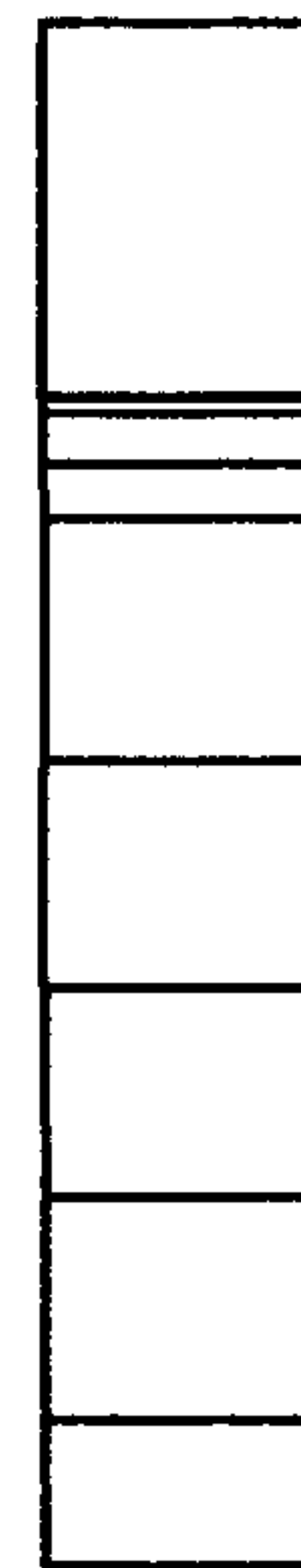

FIG. 6

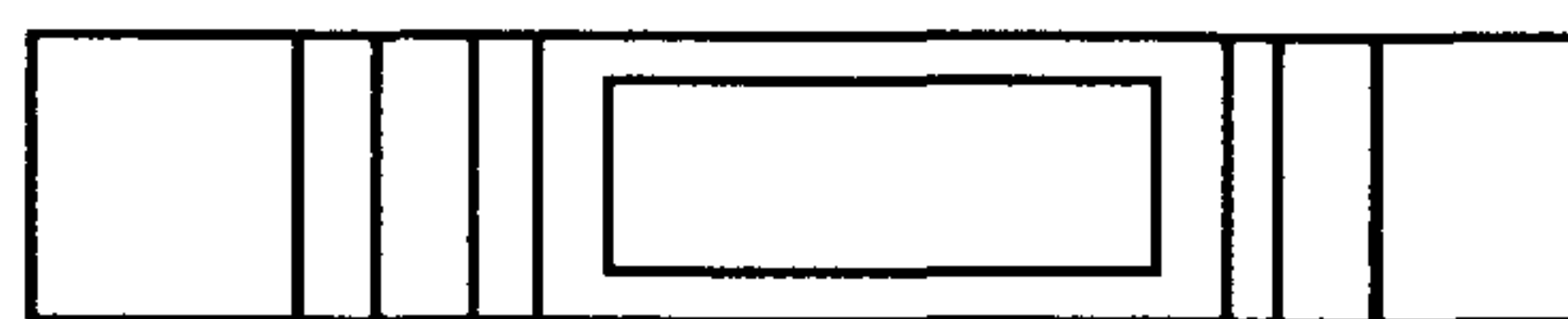

FIG. 5

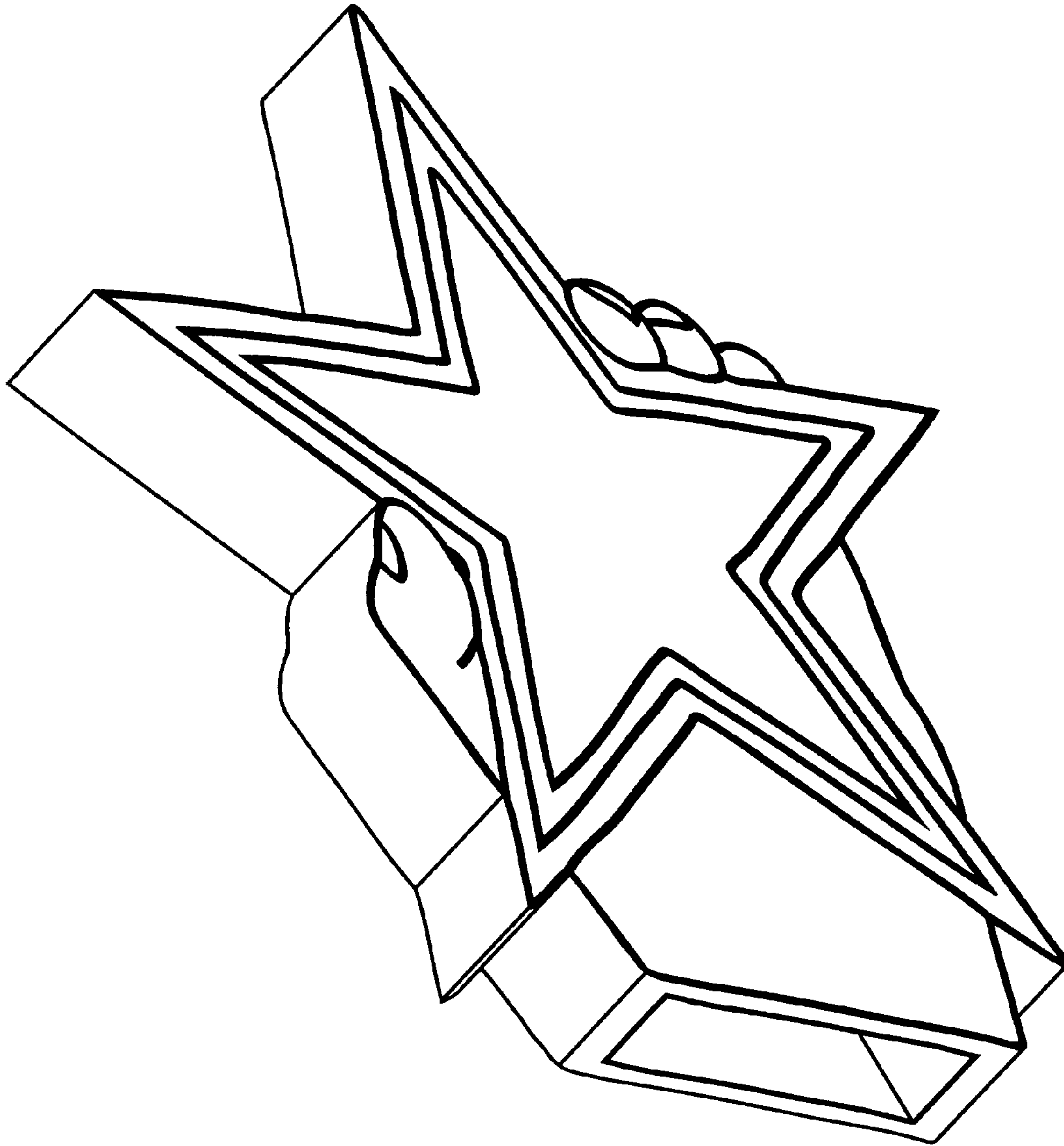

FIG. 7

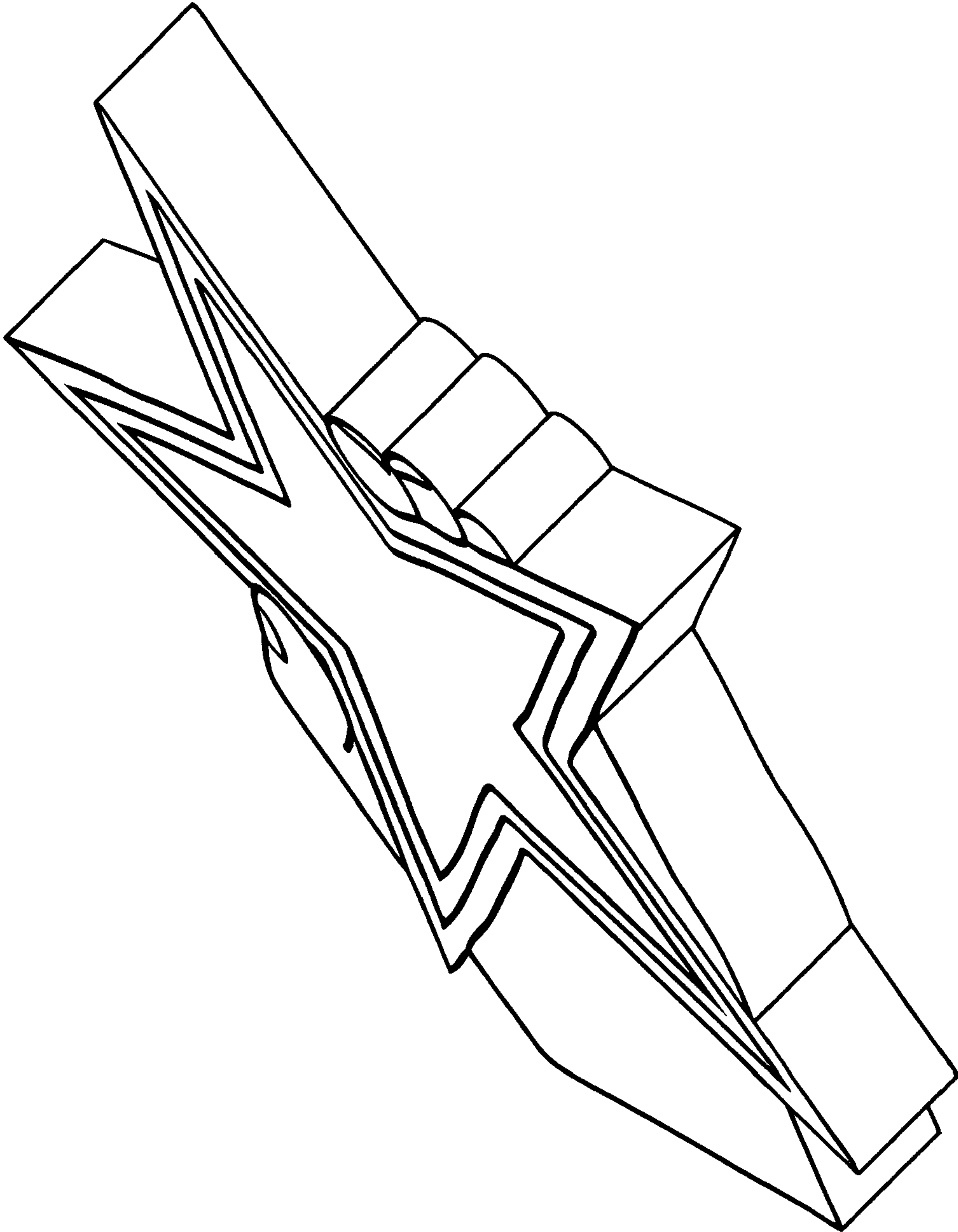

FIG. 8

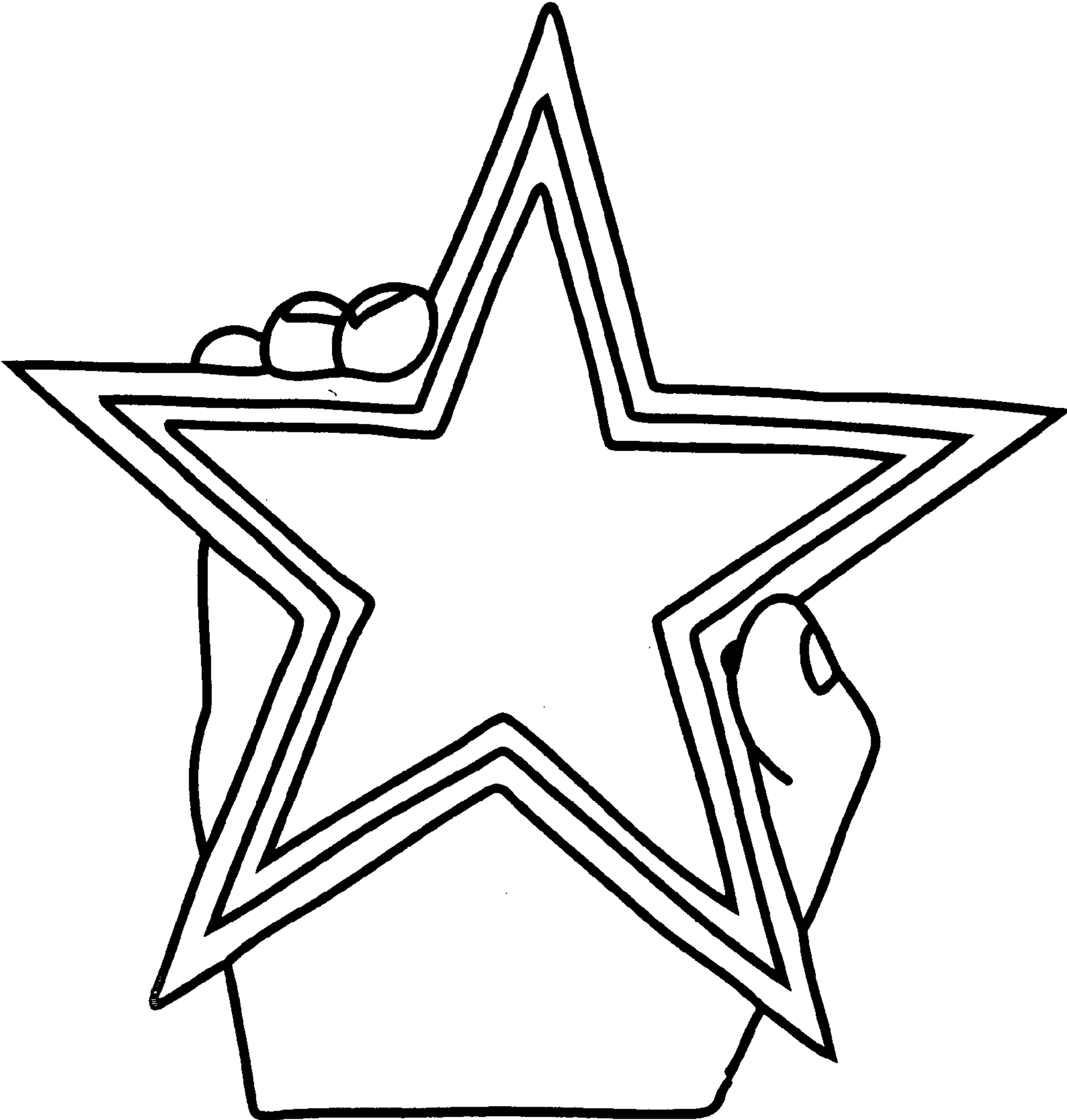

FIG. 9

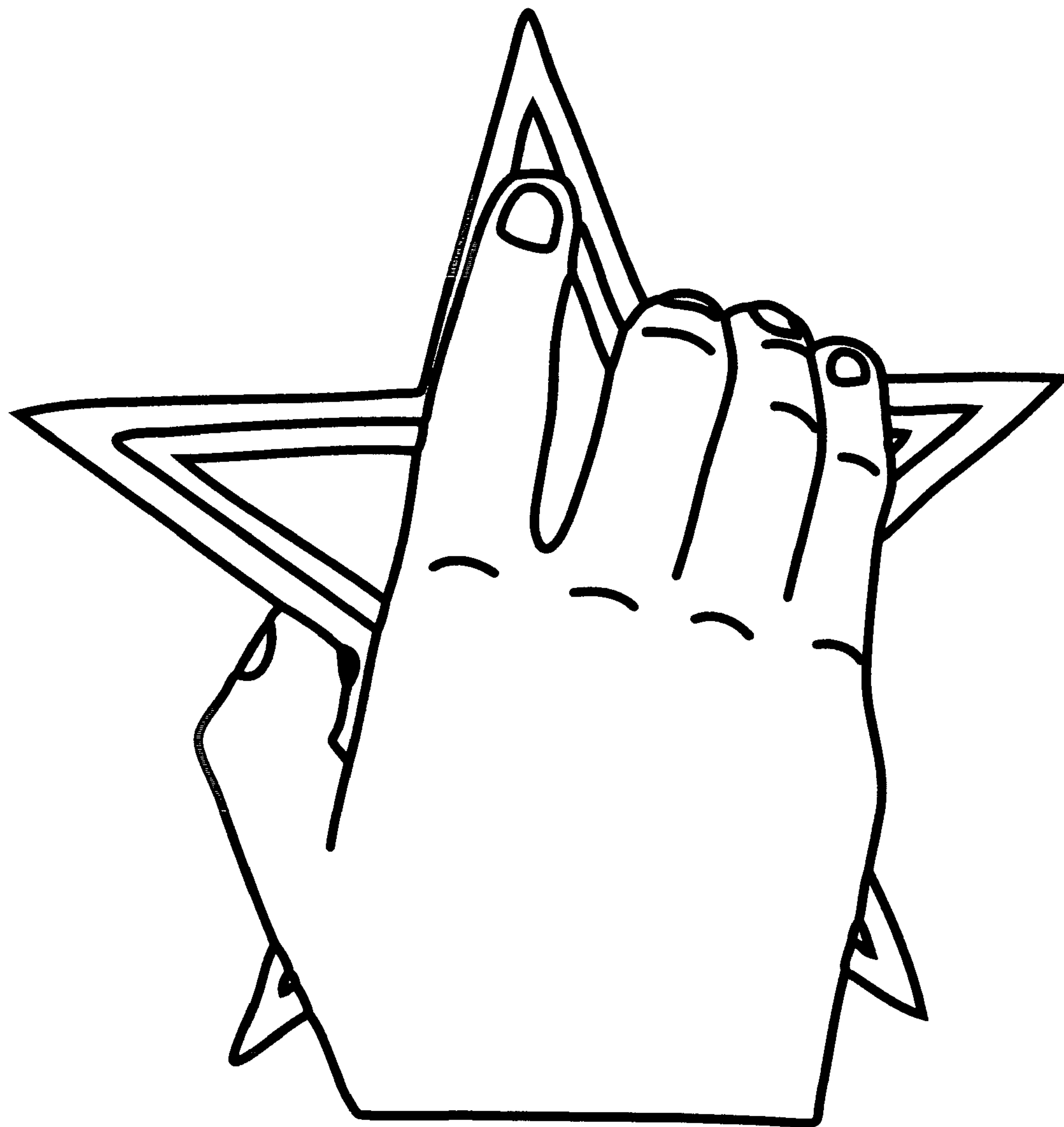

FIG. 10



FIG. 12

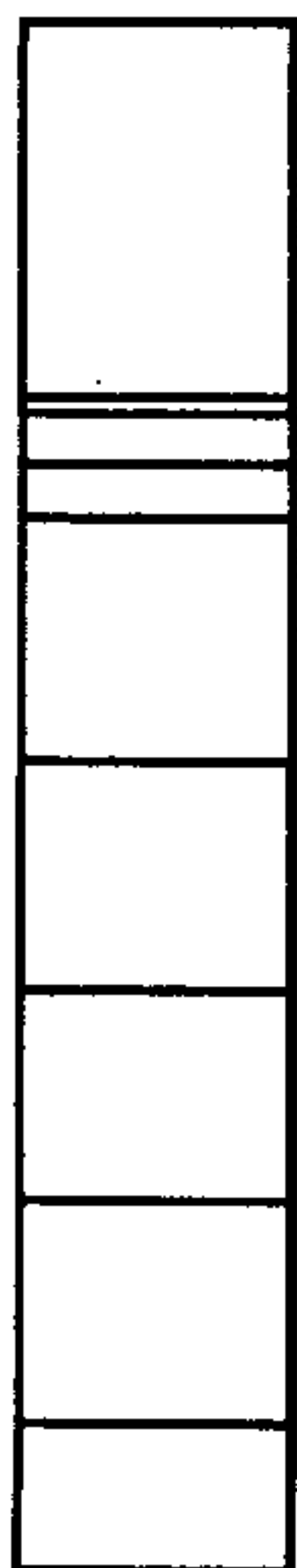

FIG. 11

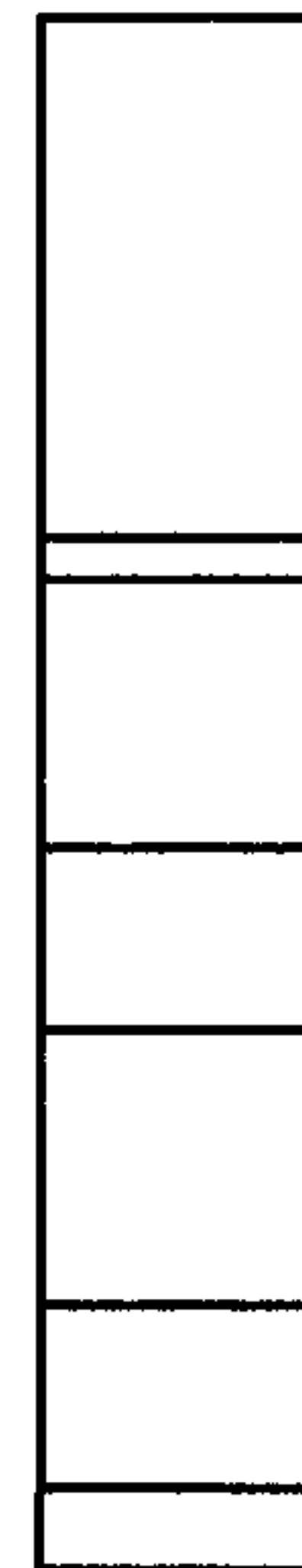

FIG. 14

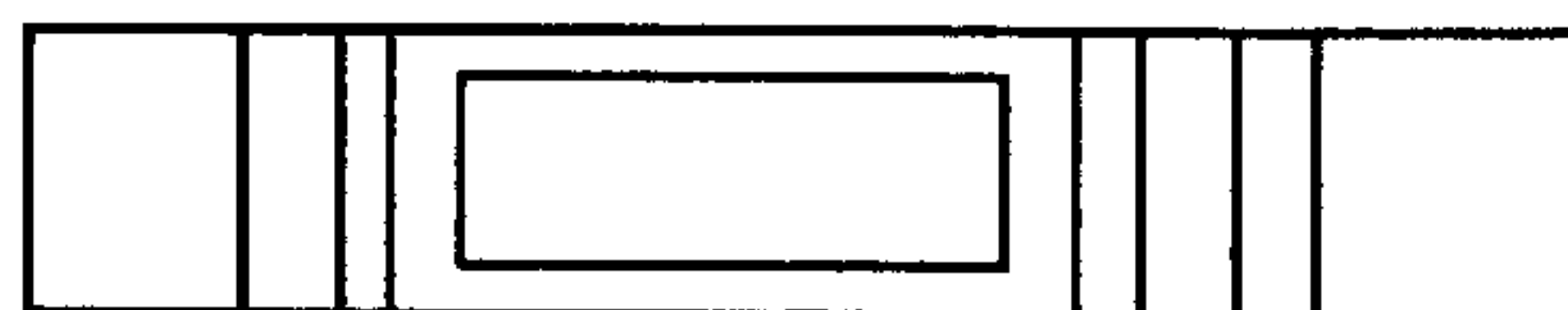

FIG. 13

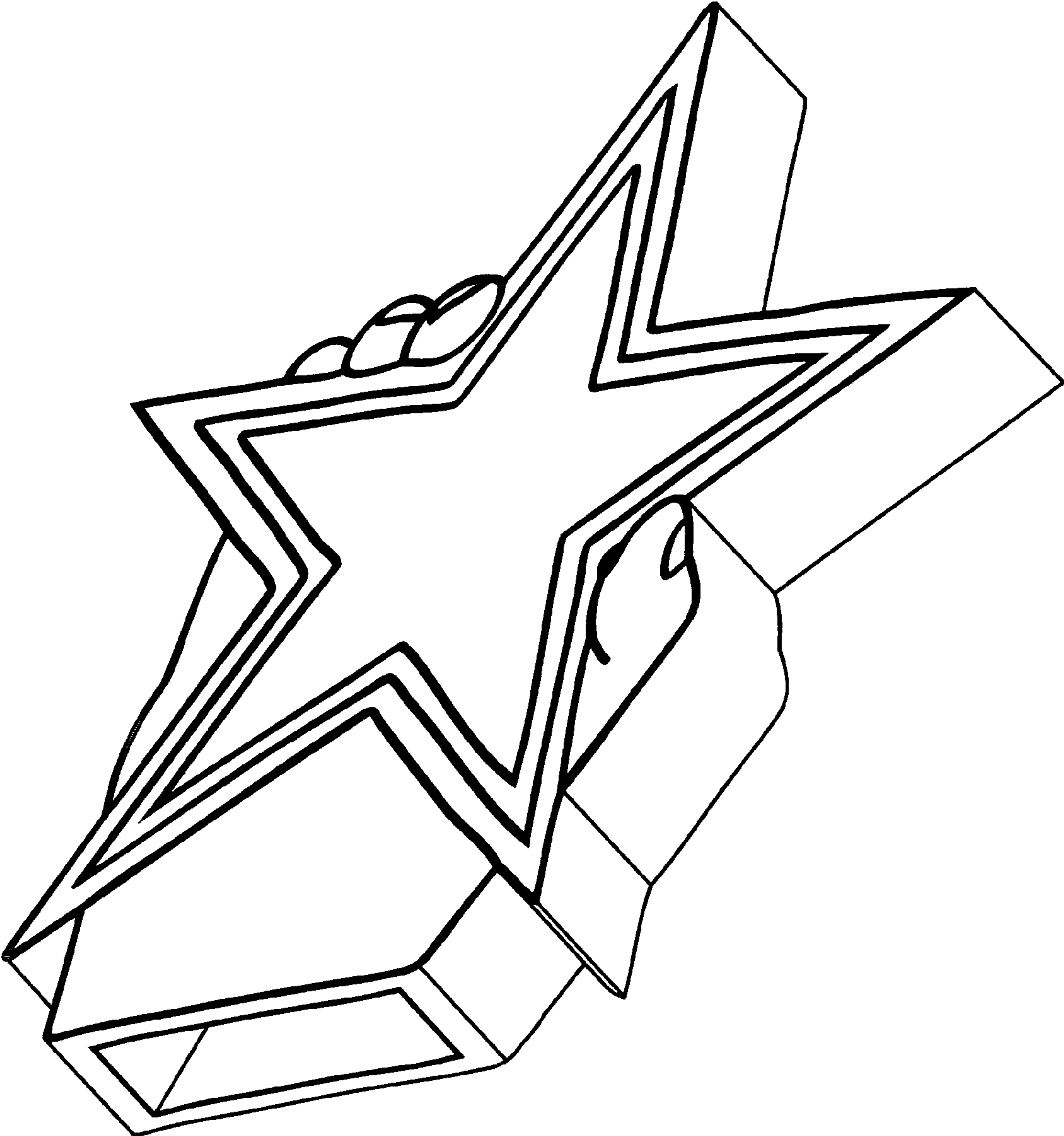

FIG. 15

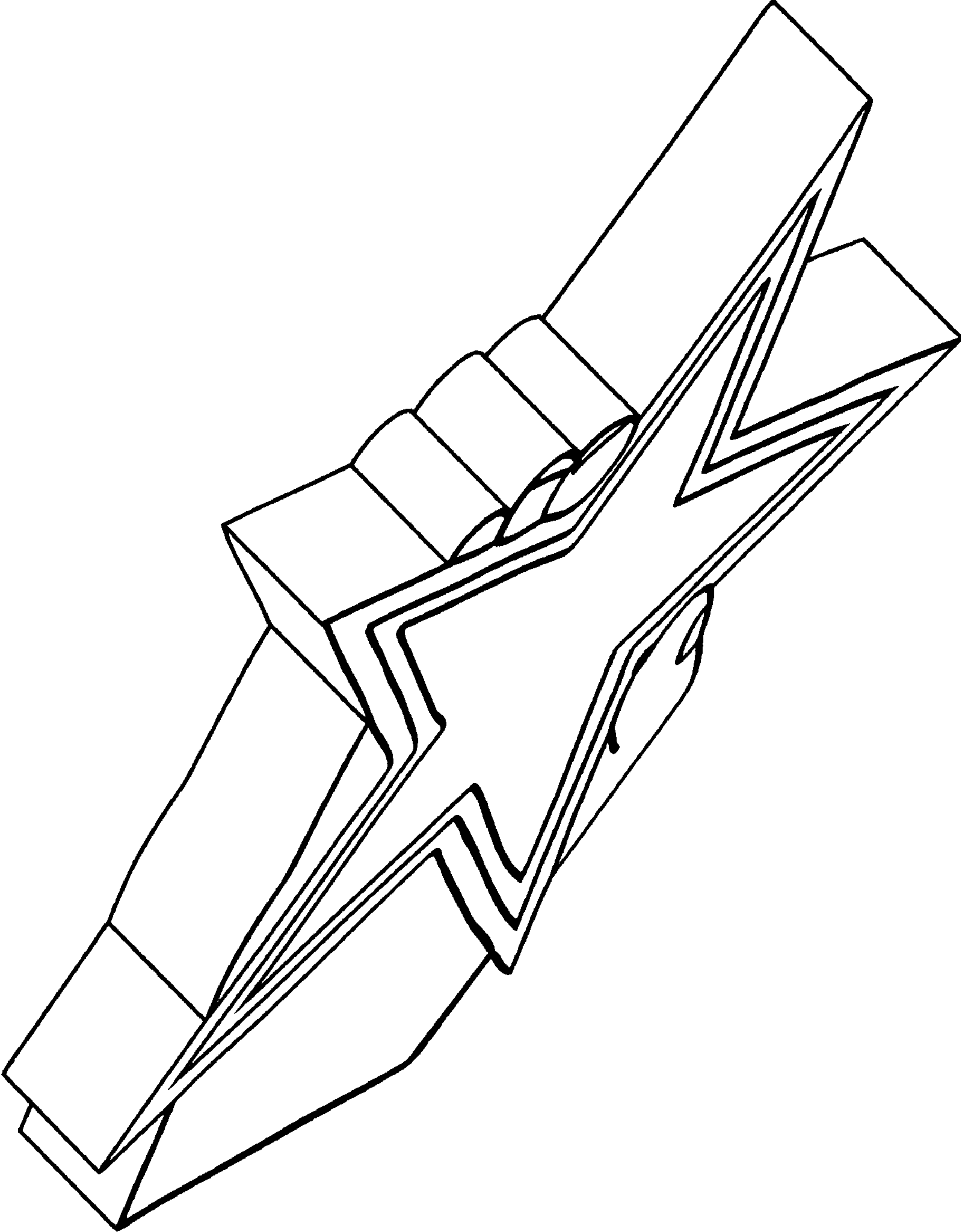

FIG. 16