



US00D664085S

(12) **United States Design Patent**  
**Callender**

(10) **Patent No.:** **US D664,085 S**

(45) **Date of Patent:** **\*\* Jul. 24, 2012**

(54) **ELECTRIC VEHICLE SUPPLY EQUIPMENT**

(75) Inventor: **Matthew Hans Callender**, Pasadena, CA (US)

(73) Assignee: **AeroVironment, Inc.**, Monrovia, CA (US)

(\*\*) Term: **14 Years**

(21) Appl. No.: **29/383,593**

(22) Filed: **Jan. 19, 2011**

(51) **LOC (9) Cl.** ..... **13-02**

(52) **U.S. Cl.** ..... **D13/107**

(58) **Field of Classification Search** ..... D13/106–110, D13/118–119, 184, 199; D15/9; 320/103–115  
See application file for complete search history.

(56) **References Cited**

**U.S. PATENT DOCUMENTS**

D237,718 S	11/1975	Bozich	.....	D13/139.5
D290,599 S	6/1987	Wyatt	.....	D13/139.5
5,461,299 A *	10/1995	Bruni	.....	320/108
D431,477 S	10/2000	Stekelenburg	.....	D10/40
6,459,234 B2	10/2002	Kajiura	.....	320/109
D608,731 S	1/2010	Amit	.....	D13/107
D608,734 S	1/2010	Smith	.....	D13/107
D626,063 S	10/2010	Cutter et al.	.....	D13/107
D626,065 S *	10/2010	Cutter et al.	.....	D13/107
D628,960 S *	12/2010	Shimizu et al.	.....	D13/107
D629,747 S *	12/2010	Rajakaruna	.....	D13/107
D632,645 S	2/2011	Blain	.....	D13/107
D634,267 S	3/2011	Blain	.....	D13/107
D641,316 S *	7/2011	Schneiderat	.....	D13/107
D641,317 S	7/2011	Schneiderat	.....	D13/107
D641,694 S *	7/2011	Akahori et al.	.....	D13/107
2010/0053943 A1	3/2010	Zick	.....	362/183
2011/0145141 A1	6/2011	Blain	.....	705/39
2011/0169447 A1	7/2011	Brown et al.	.....	320/109

**OTHER PUBLICATIONS**

USPTO Notice of Allowance and Fees Due, mailed Oct. 13, 2011 for U.S. Appl. No. 29/383,594, filed Jan. 20, 2011, Inventor Matthew Callender.

\* cited by examiner

*Primary Examiner* — Rosemary K Tarcza

(74) *Attorney, Agent, or Firm* — Christopher R. Balzan; Eric J. Aagaard

(57) **CLAIM**

I claim the ornamental design for a electric vehicle supply equipment, as shown and described.

**DESCRIPTION**

FIG. 1 is a front-right perspective view of an embodiment of an electric vehicle supply equipment;

FIG. 2 is a front view of the electric vehicle supply equipment of FIG. 1;

FIG. 3 is a rear view of the electric vehicle supply equipment of FIG. 1;

FIG. 4 is a left side view of the electric vehicle supply equipment of FIG. 1;

FIG. 5 is a right side view of the electric vehicle supply equipment of FIG. 1;

FIG. 6 is a top view of the electric vehicle supply equipment of FIG. 1; and,

FIG. 7 is a bottom view of the electric vehicle supply equipment of FIG. 1.

The broken lines shown in the drawings are included for the purpose of illustrating unclaimed portions of the electric vehicle supply equipment and form no part of the claimed design.

**1 Claim, 4 Drawing Sheets**

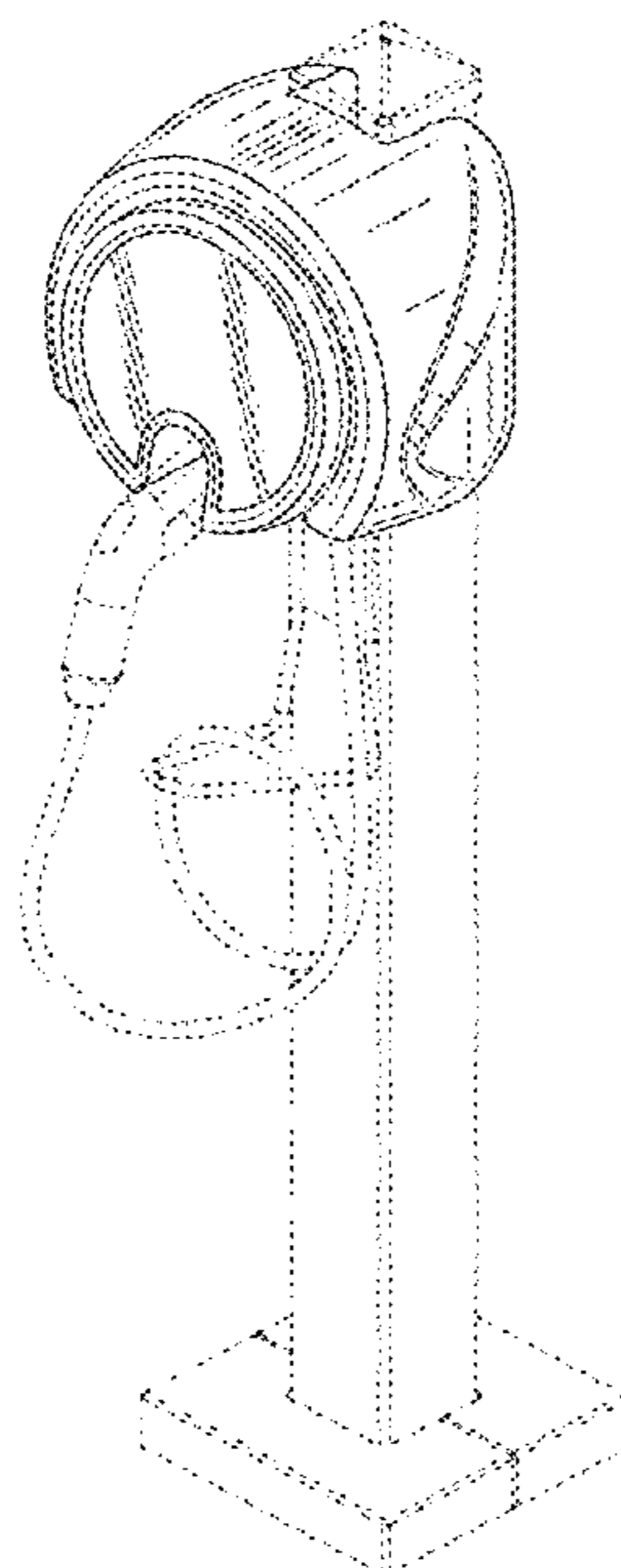

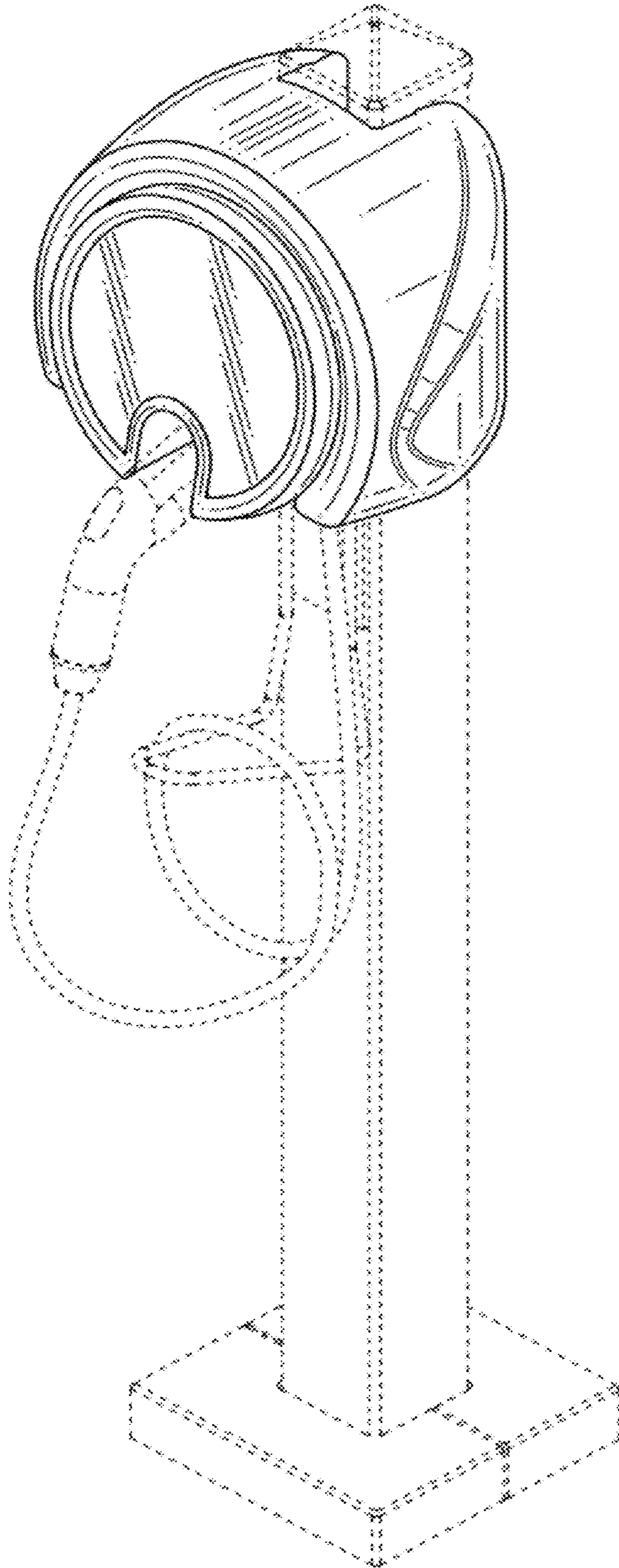

FIG. 1

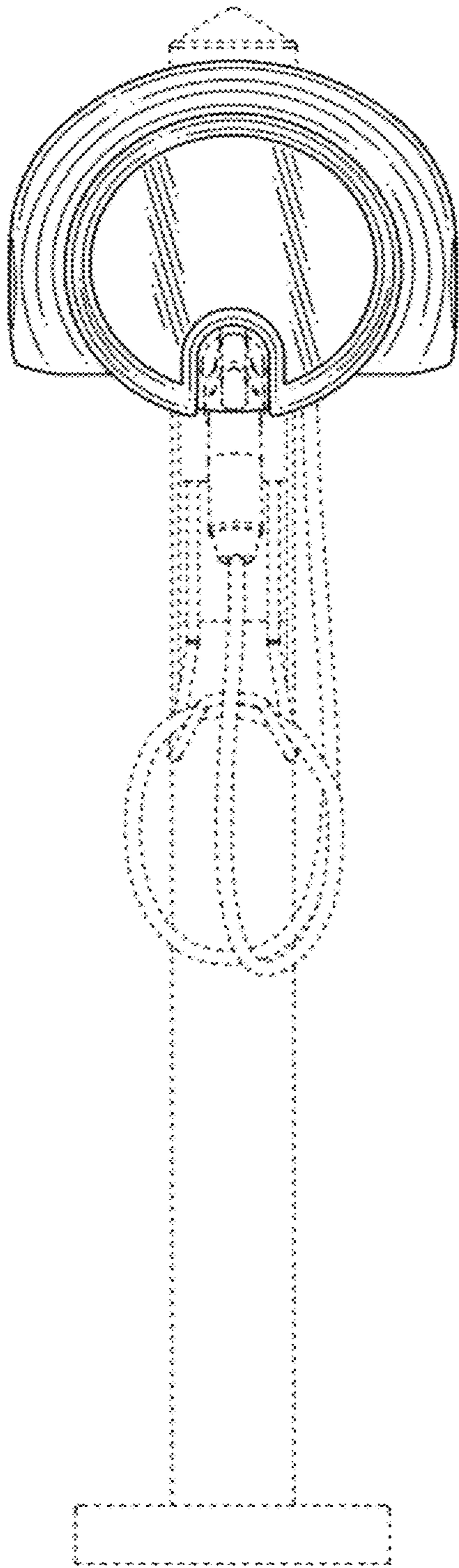

FIG. 2

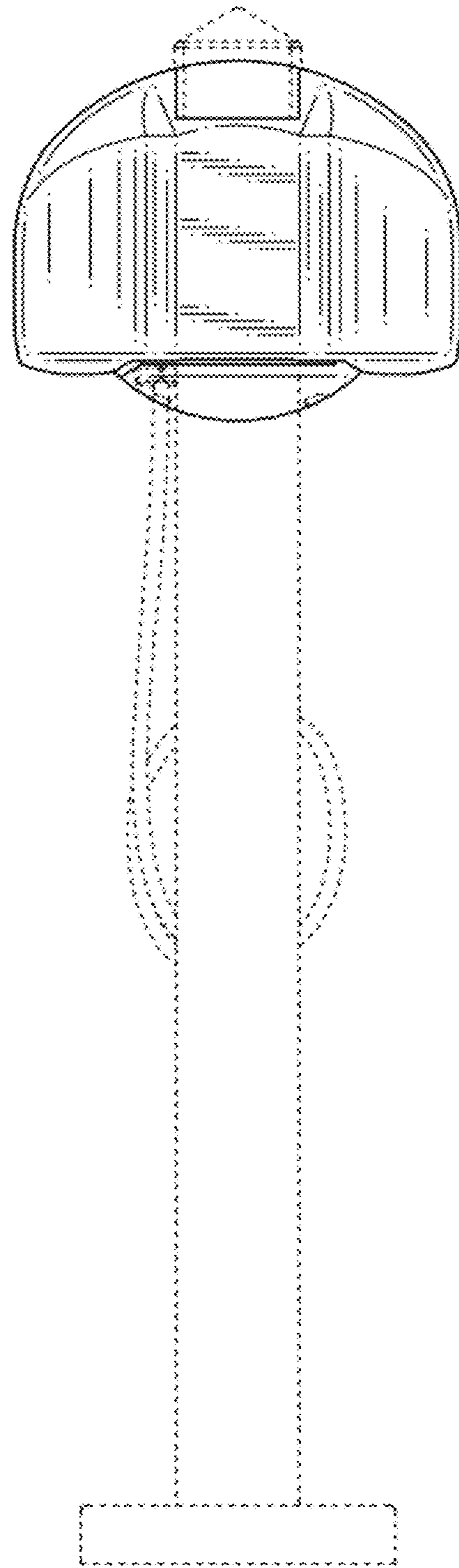

FIG. 3

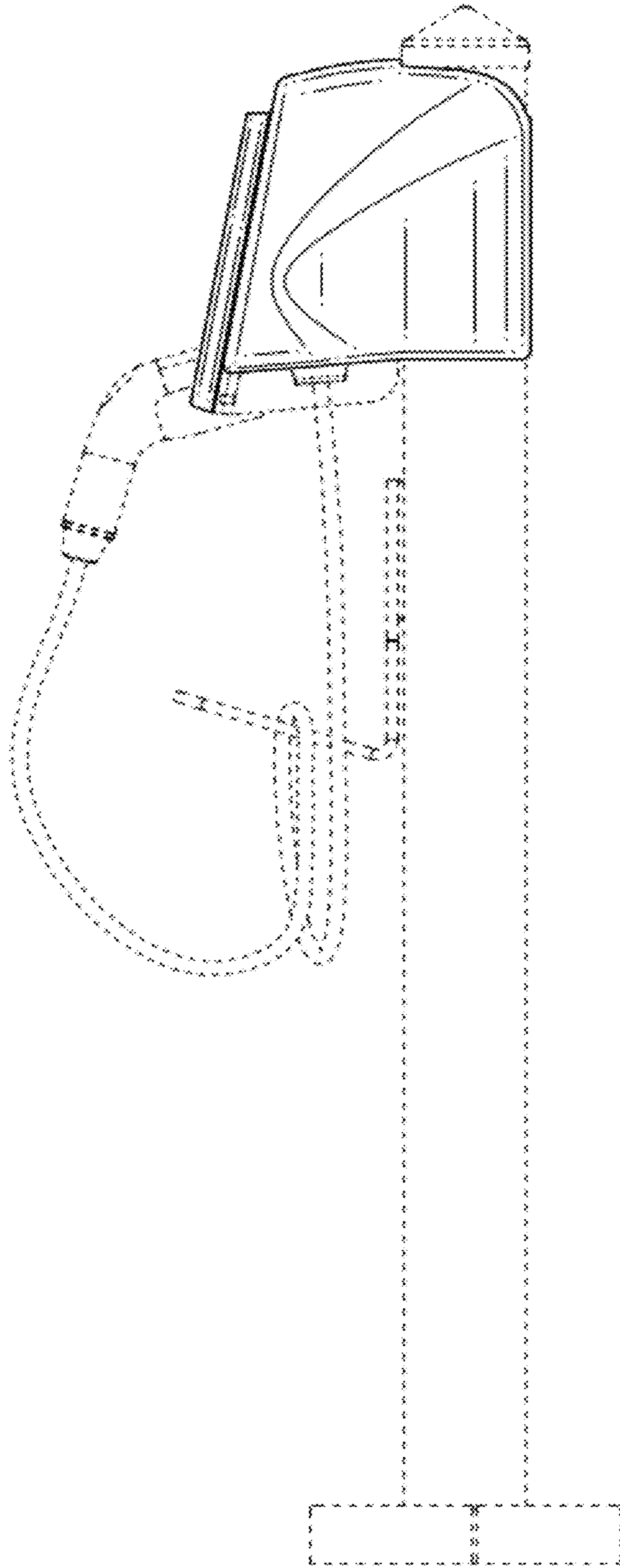

FIG. 4

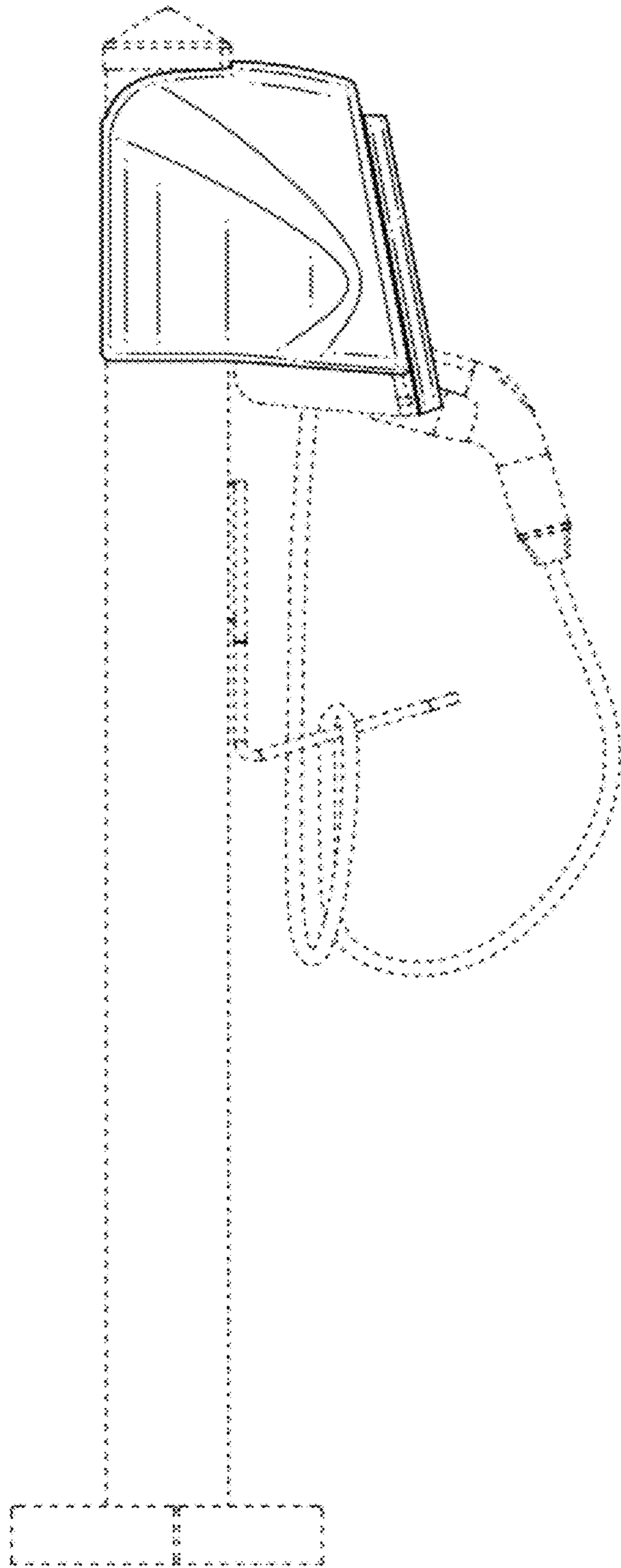

FIG. 5

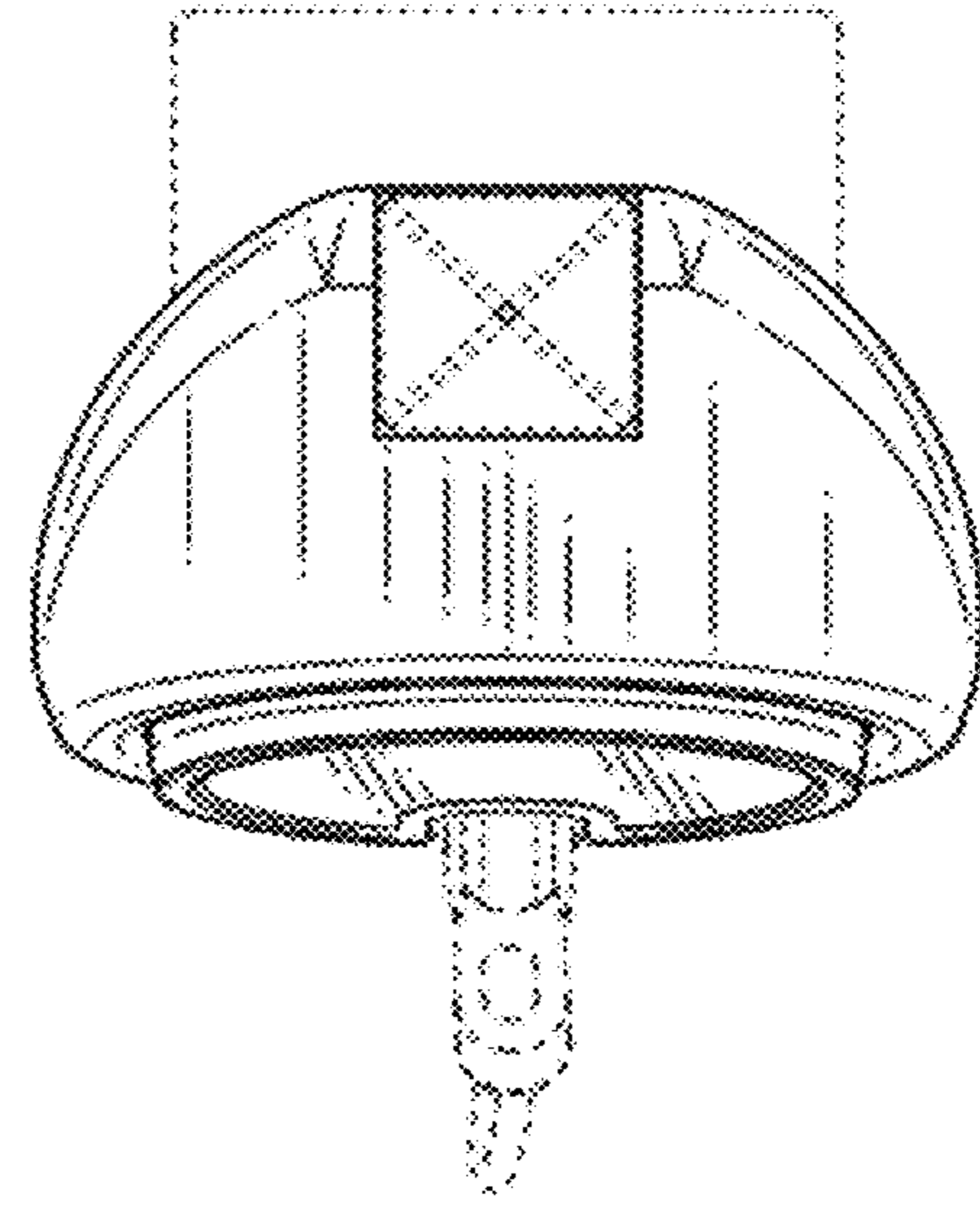

FIG. 6

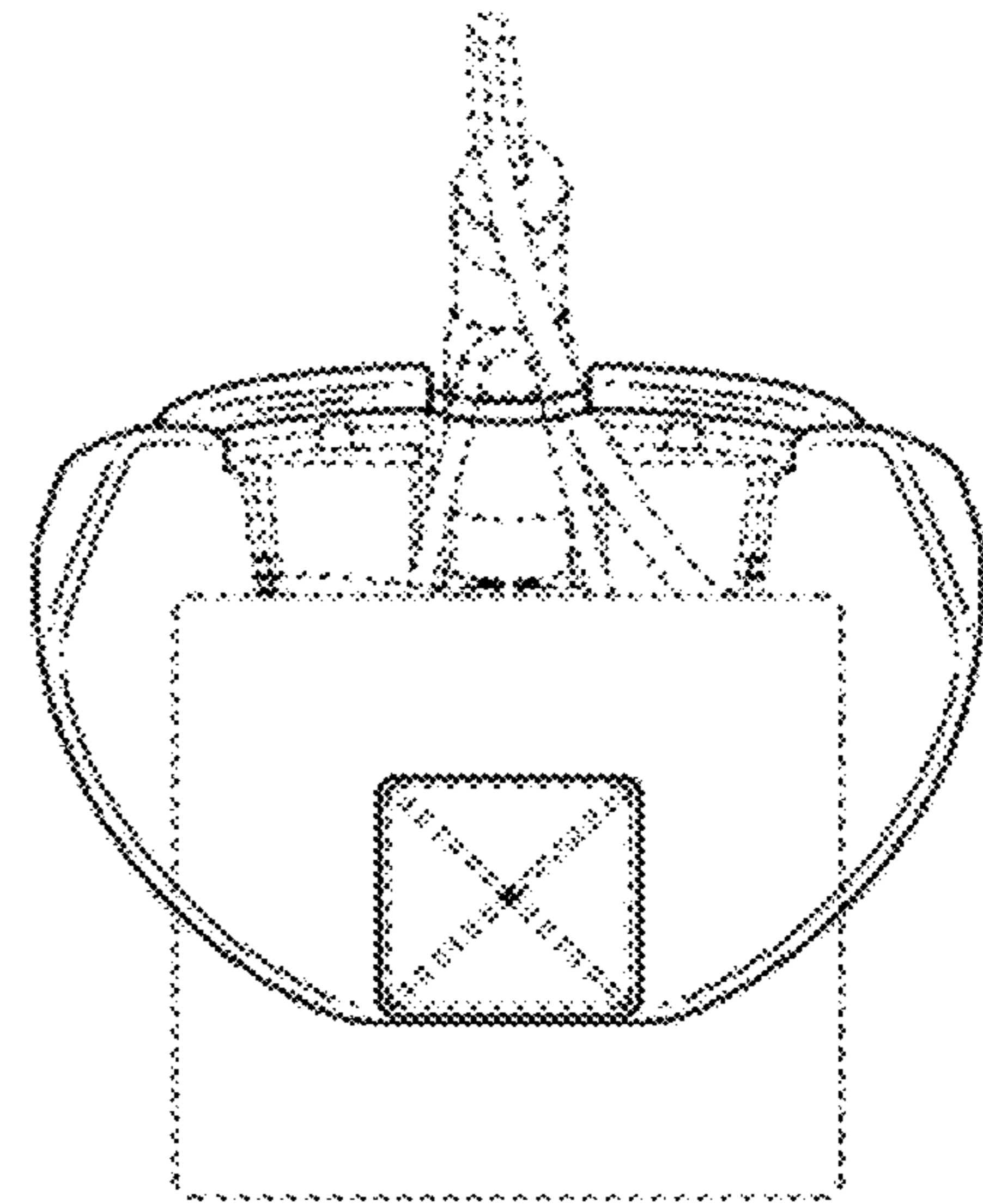

FIG. 7