



US00D663956S

(12) **United States Design Patent**  
**Swaggart**

(10) **Patent No.:** **US D663,956 S**

(45) **Date of Patent:** **\*\* Jul. 24, 2012**

(54) **WRIST STRAP FOR A CAMERA**

(76) Inventor: **Matthew Swaggart**, Tulsa, OK (US)

(\*\*) Term: **14 Years**

(21) Appl. No.: **29/393,709**

(22) Filed: **Jun. 8, 2011**

(51) **LOC (9) Cl.** ..... **03-01**

(52) **U.S. Cl.** ..... **D3/327**

(58) **Field of Classification Search** ..... D3/327,  
D3/229, 316, 302; 62/457.9; 294/137, 155-157,  
294/149, 150, 165; 224/578-580, 250, 259,  
224/901.4, 148.4, 258, 270, 901.8

See application file for complete search history.

(56) **References Cited**

**U.S. PATENT DOCUMENTS**

D195,850 S *	8/1963	Contardi	.....	D3/224
D269,140 S *	5/1983	Holmes	.....	D3/229
D355,067 S *	2/1995	Pytlewski	.....	D29/122
D359,836 S *	7/1995	Shuler	.....	D29/101.5
6,398,092 B1 *	6/2002	Ansley	.....	224/582
7,028,871 B1 *	4/2006	Glover et al.	.....	224/258

\* cited by examiner

*Primary Examiner* — Sheryl Lane

(74) *Attorney, Agent, or Firm* — Charles D. Gunter, Jr.

(57) **CLAIM**

The ornamental design for a wrist strap for a camera, as shown and described.

**DESCRIPTION**

FIG. 1 is a perspective view of the wrist strap for a camera of the invention shown in use with the hand of a user and an associated camera shown in dotted lines as not forming a portion of the present invention;

FIG. 2 is an isolated, perspective view of the wrist strap for a camera of FIG. 1;

FIG. 3 is an end view of the wrist strap for a camera of the invention, taken from the left end of the strap as presented in the view of FIG. 2;

FIG. 4 is an end view of the wrist strap for a camera of the invention, taken from the right end of the strap as presented in the view of FIG. 2;

FIG. 5 is a side view of the wrist strap for a camera of the invention, taken from the left side of the view as presented in FIG. 2;

FIG. 6 is a top view of the wrist strap for a camera of the invention; and,

FIG. 7 is a bottom view of the wrist strap for a camera of the invention.

The dashed lines representing stitching do form part of the claimed design.

**1 Claim, 4 Drawing Sheets**

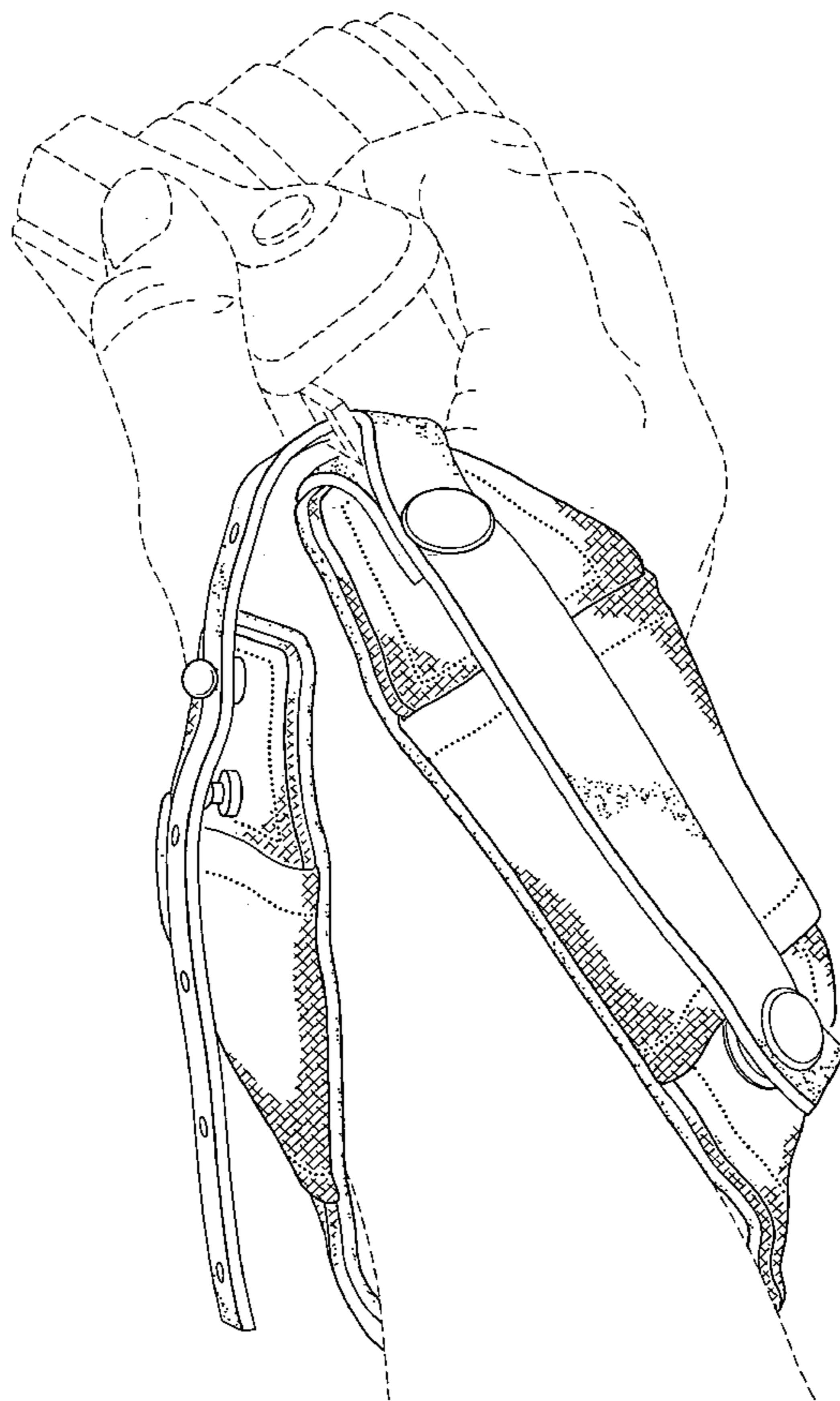

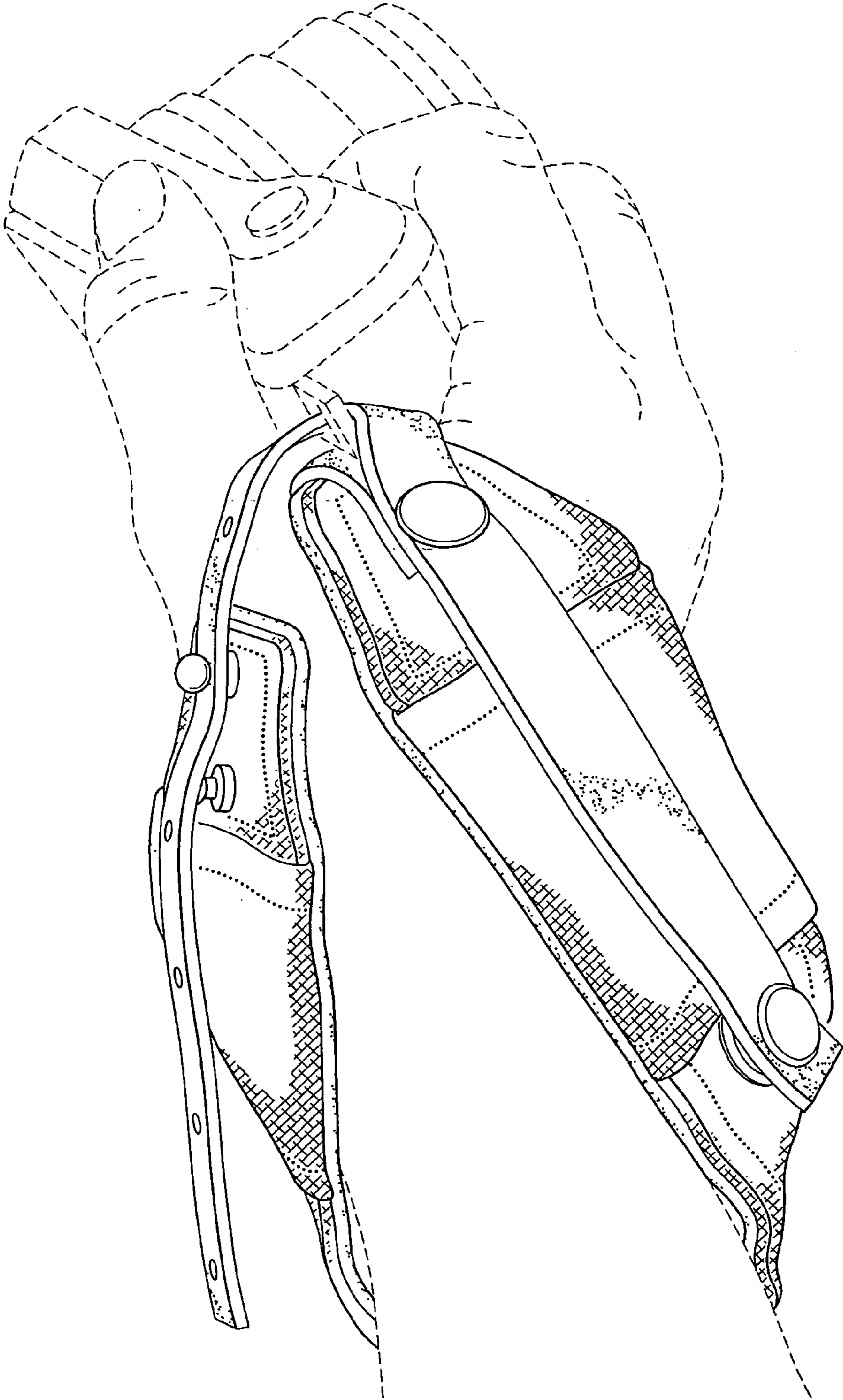

FIG. 1

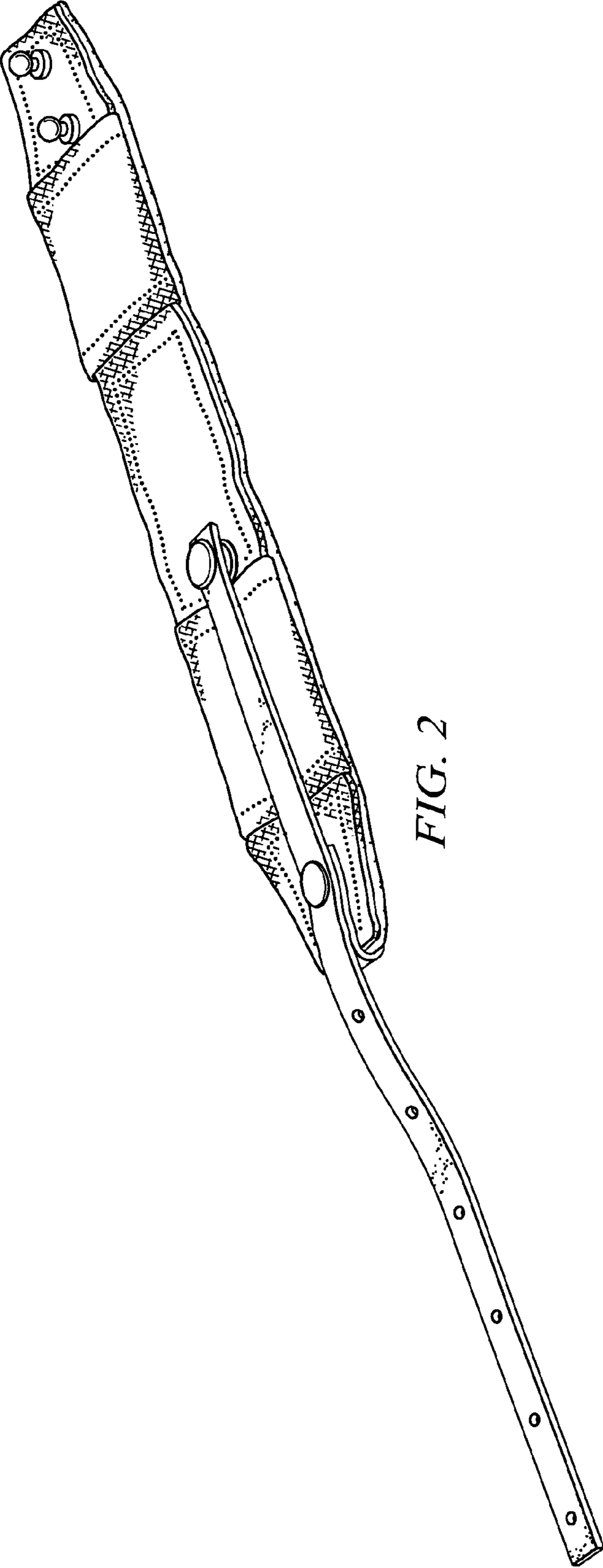

FIG. 2

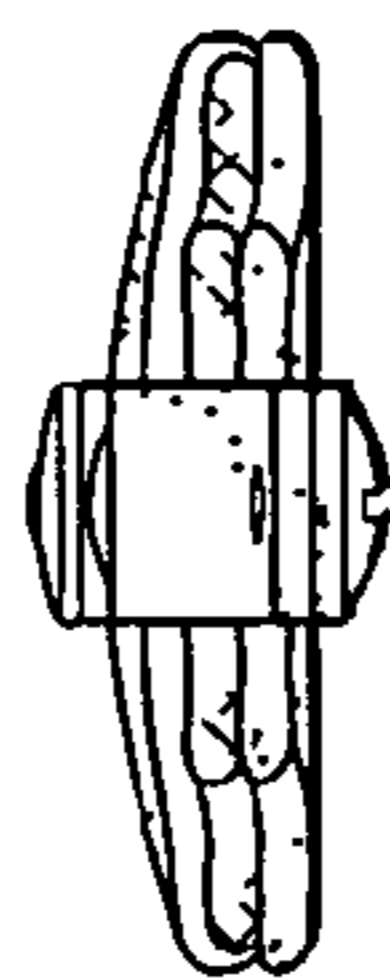

FIG. 3

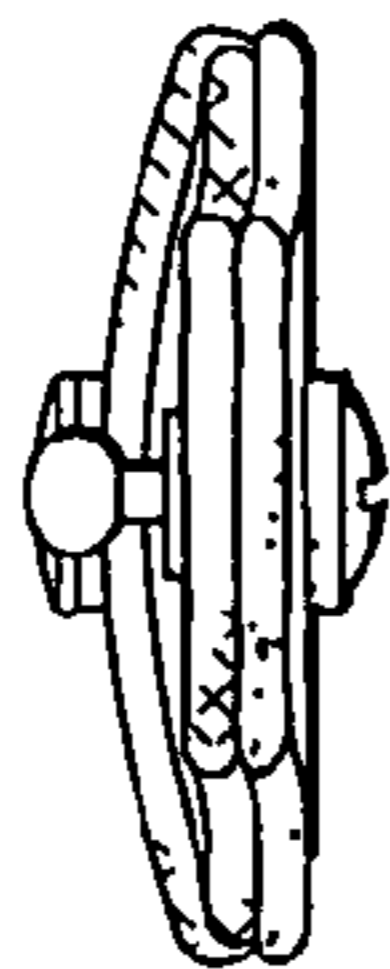

FIG. 4

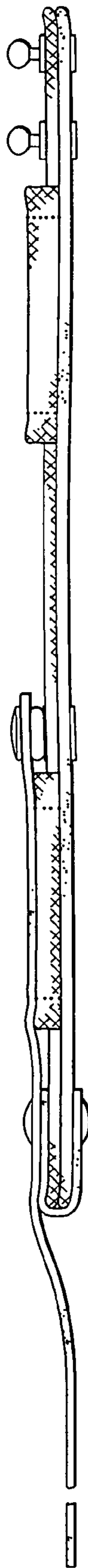

FIG. 5

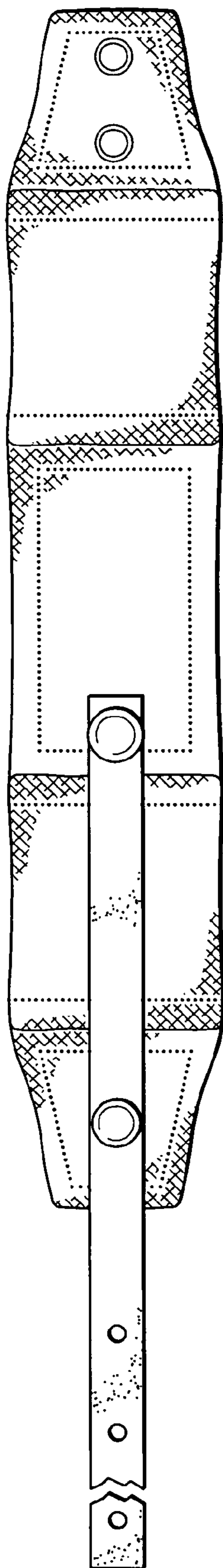

FIG. 6

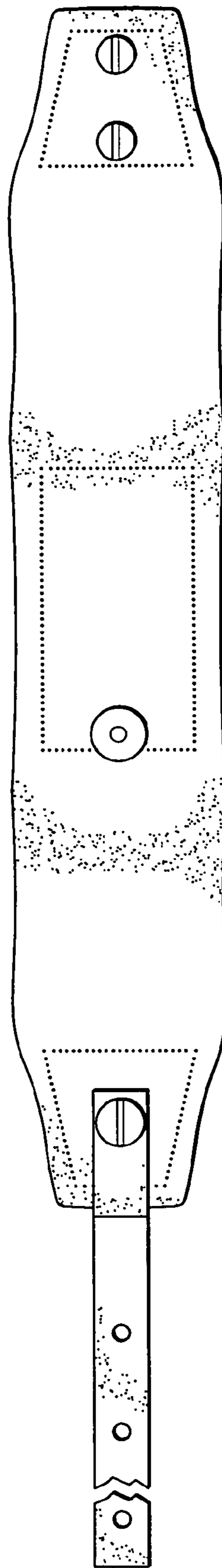

FIG. 7