



US00D663946S

(12) **United States Design Patent**
Powers

(10) **Patent No.:** **US D663,946 S**
(45) **Date of Patent:** **** Jul. 24, 2012**

(54) **COVER FOR EA DESIGN_01 CONTAINMENT SYSTEM**
(76) Inventor: **Brenda Bagavathi Powers**, Alameda, CA (US)
(**) Term: **14 Years**
(21) Appl. No.: **29/388,852**
(22) Filed: **Apr. 3, 2011**
(51) **LOC (9) Cl.** **03-01**
(52) **U.S. Cl.** **D3/203.1**
(58) **Field of Classification Search** D3/201-205, D3/260, 262, 272-274, 281, 291, 294-295, D3/301-302, 905; 206/315.11, 811, 532-540; 220/4.021-4.24
See application file for complete search history.

D469,544 S 1/2003 Lafond et al.
D490,308 S 5/2004 Hunger
D524,537 S 7/2006 Priebe et al.
D526,478 S 8/2006 Priebe et al.
7,147,127 B2 12/2006 Lepke et al.
D574,505 S 8/2008 Muller-Cohen et al.
7,571,811 B2 8/2009 Mulaw
D600,441 S 9/2009 Estrada
7,584,849 B2 9/2009 Mauk
D610,796 S 3/2010 Siegel
D614,397 S * 4/2010 Benedetti D3/203.6
7,878,337 B2 2/2011 Abdullah
D634,970 S 3/2011 Pallotto
7,896,192 B2 3/2011 Conley et al.
7,909,195 B2 3/2011 Rathbone et al.
D641,160 S * 7/2011 Minneman D3/274

* cited by examiner

Primary Examiner — Catheri Oliver

(56) **References Cited**

U.S. PATENT DOCUMENTS

D264,810 S 6/1982 Voltmann
D276,998 S 1/1985 Caven
D298,416 S 11/1988 Rakocy
D324,819 S 3/1992 Eisenberg
D338,965 S 8/1993 Glanz et al.
D349,773 S 8/1994 Malin et al.
D356,904 S 4/1995 Wolff
D357,178 S 4/1995 Shaw
D372,102 S 7/1996 Peacock et al.
D381,515 S 7/1997 Haynes
D393,203 S 4/1998 Saltzman et al.
D411,308 S 6/1999 Pandey et al.
D413,390 S 8/1999 Southern et al.
D426,461 S 6/2000 Noble
6,169,707 B1 1/2001 Neuland
D439,673 S 3/2001 Brophy et al.
D465,282 S 11/2002 Cecchi

(57) **CLAIM**
The ornamental design for the cover for EA_design_01 containment system, as shown and described.

DESCRIPTION

FIG. 1 is a top front isometric view of my cover for EA_design_01 containment system showing my new design; FIG. 2 is a front elevation view thereof; FIG. 3 is a rear elevation view thereof; FIG. 4 is a right side elevation view thereof; FIG. 5 is a left side elevation view thereof; FIG. 6 is a top plan view thereof; and, FIG. 7 is a bottom plan view thereof. The broken line showing of environment in the drawings is included for the purpose of illustrating only and forms no part of the claimed design.

1 Claim, 6 Drawing Sheets

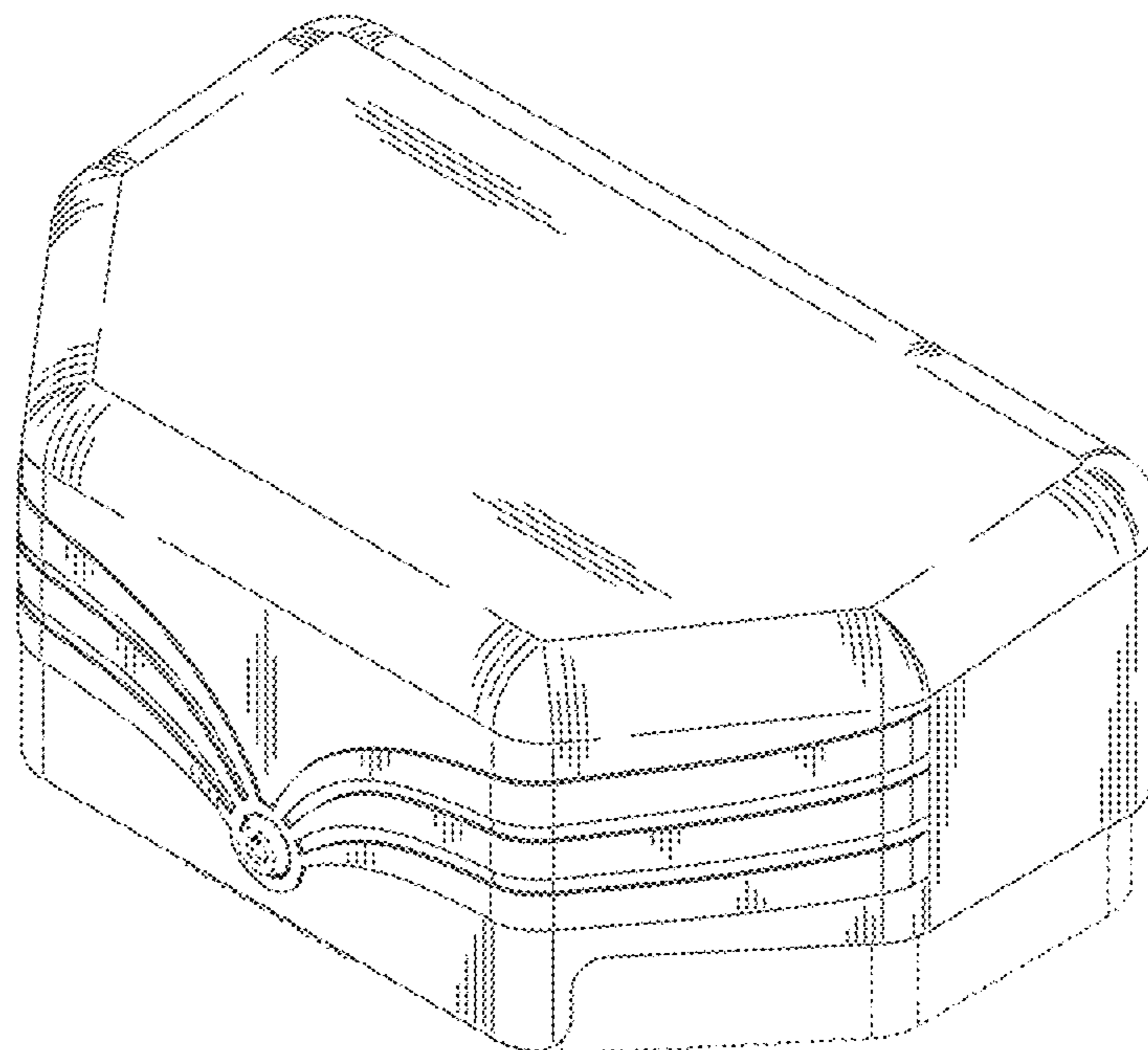

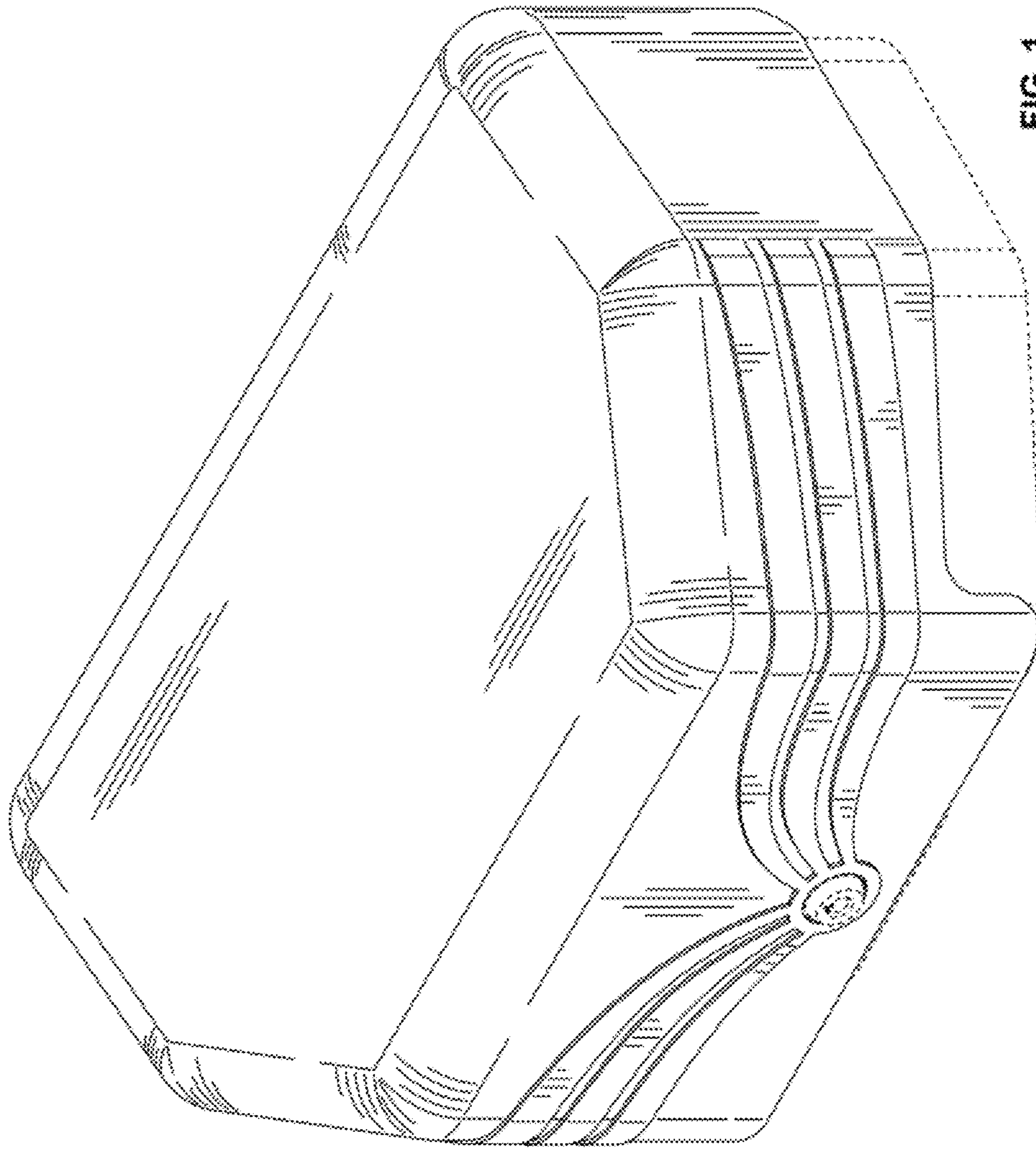

FIG. 1

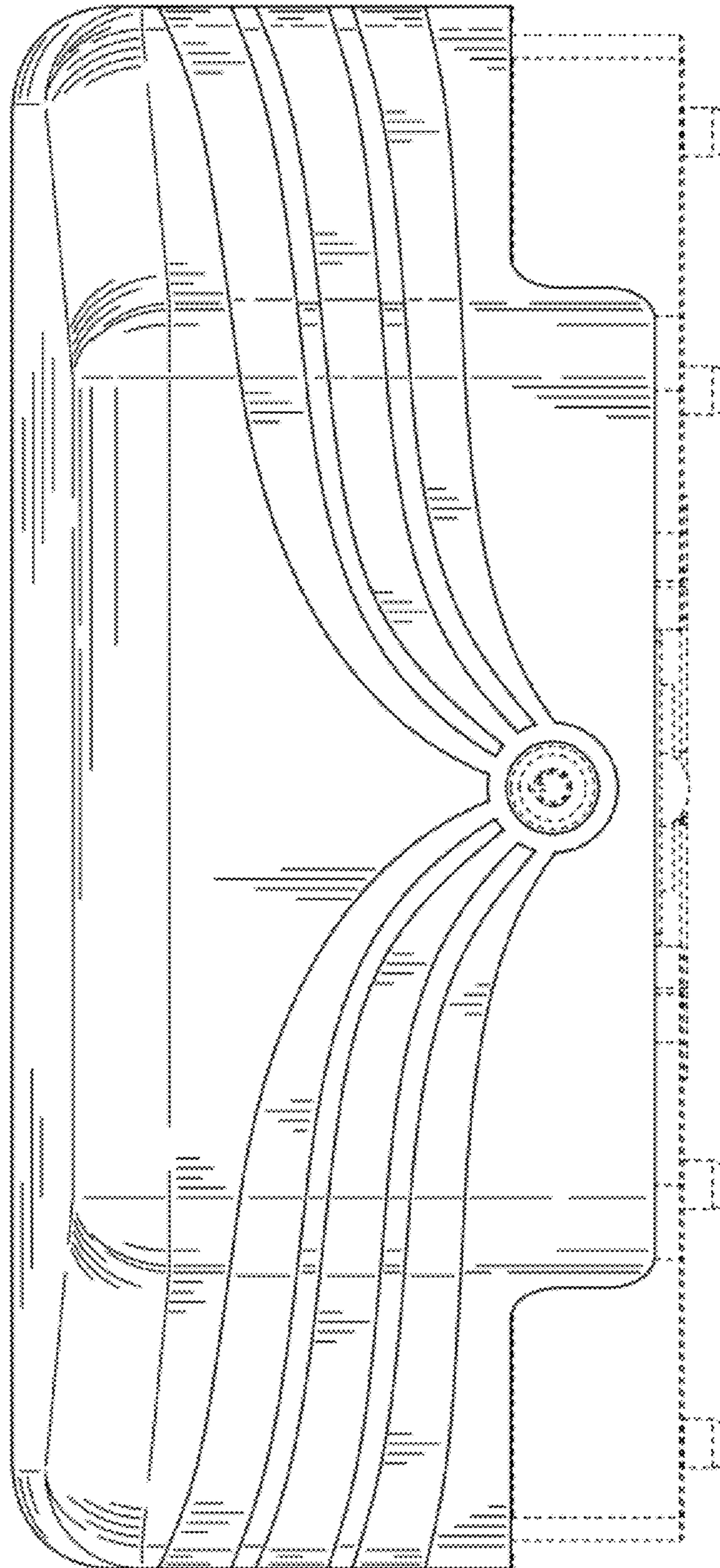

FIG. 2

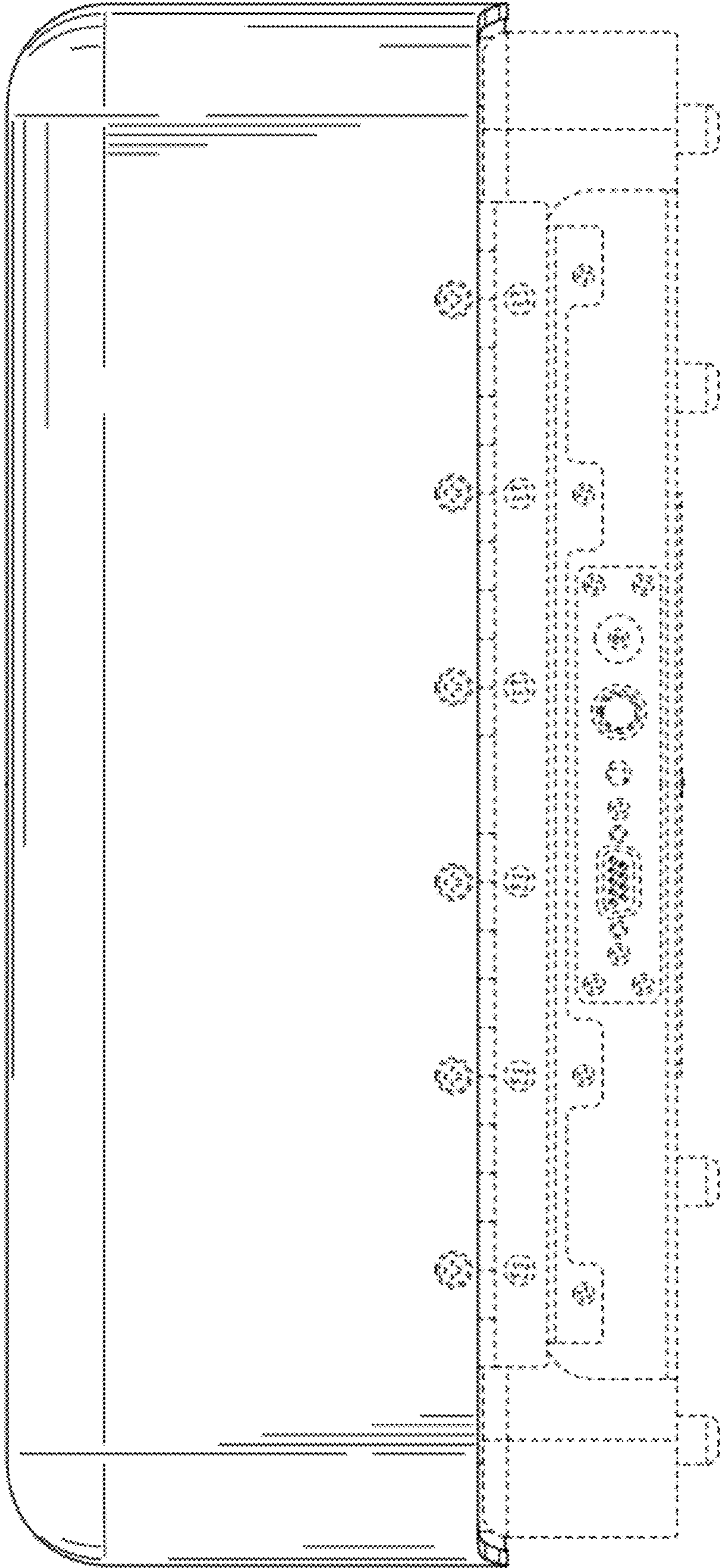

FIG. 3

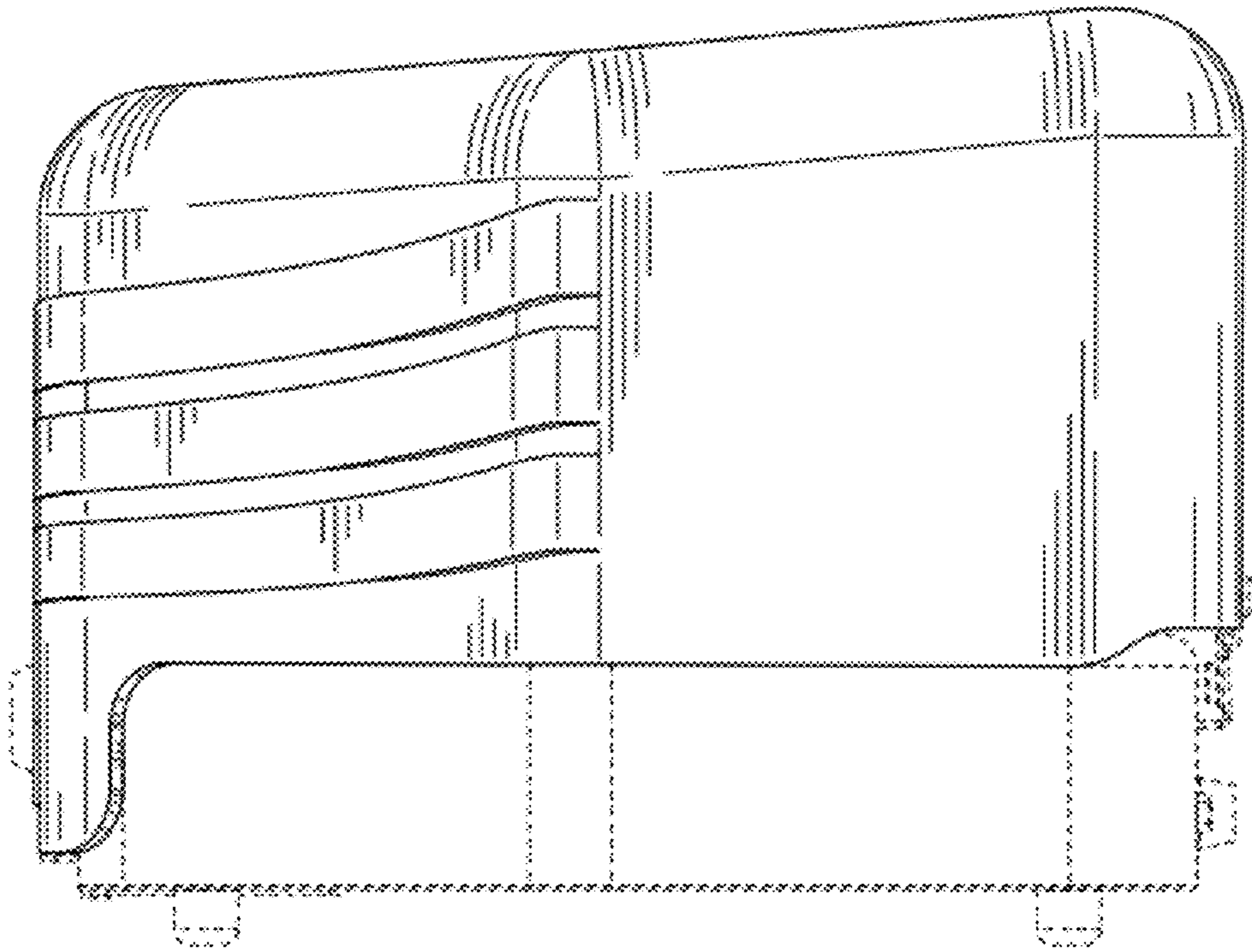

FIG. 4

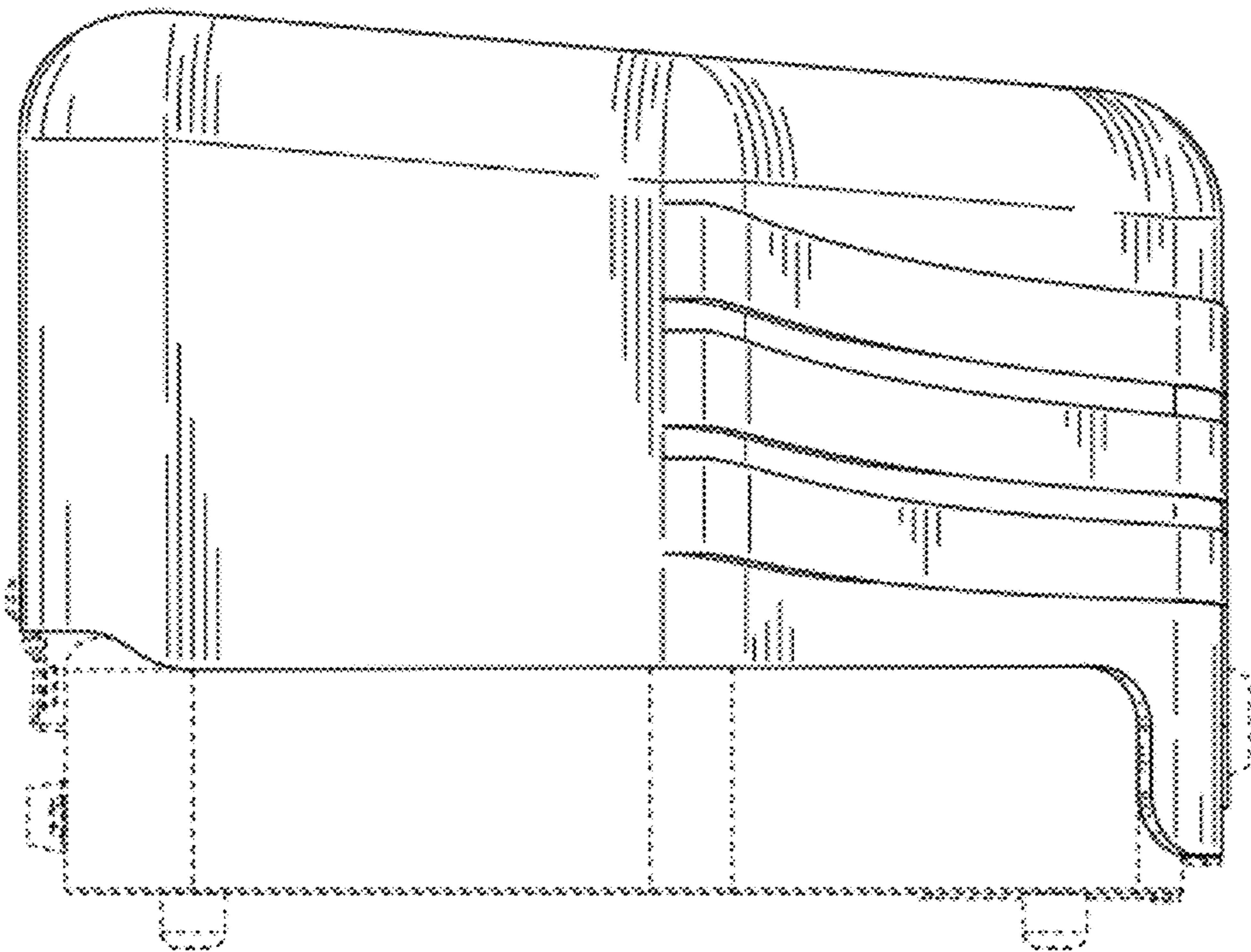

FIG. 5

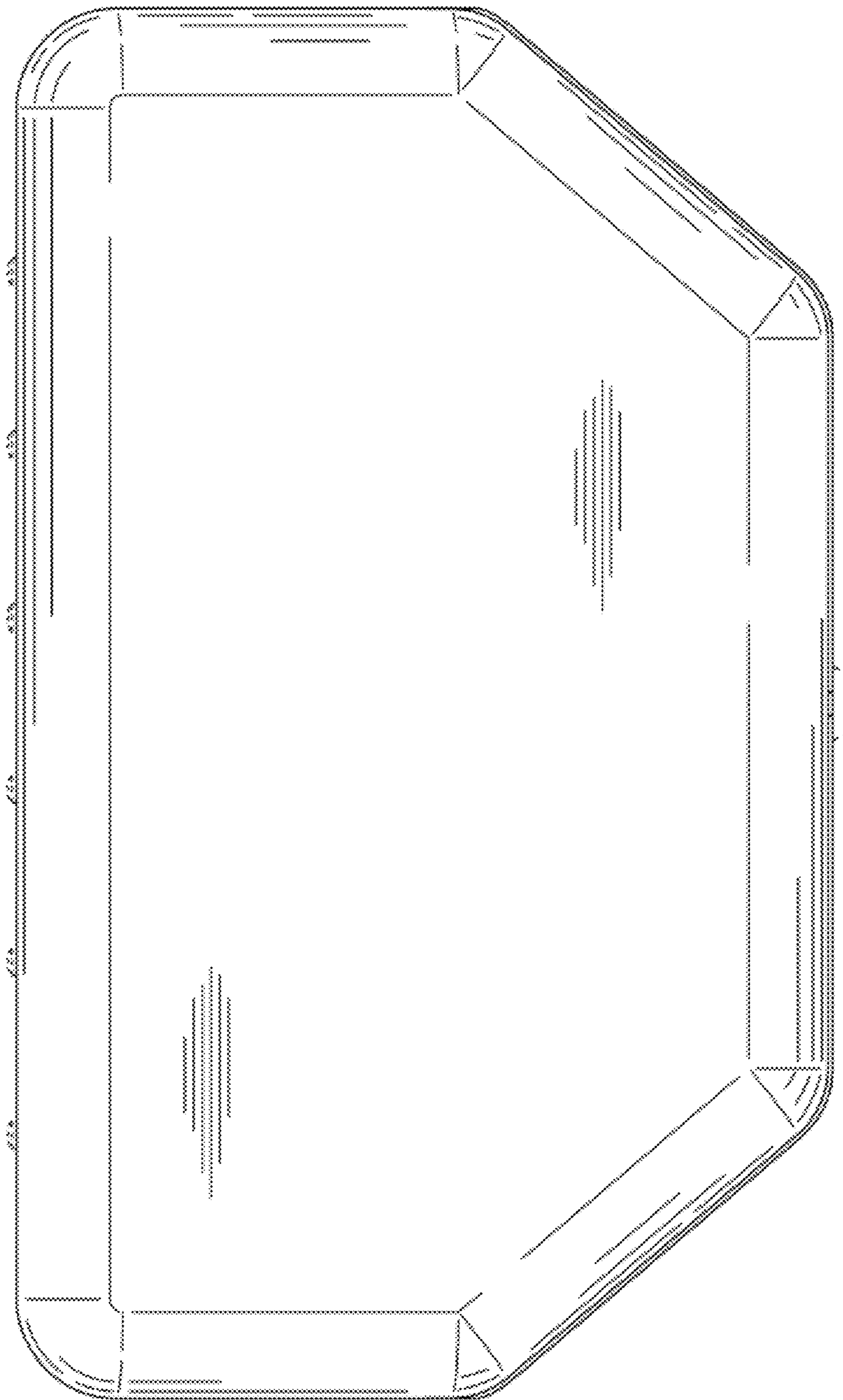

FIG. 6

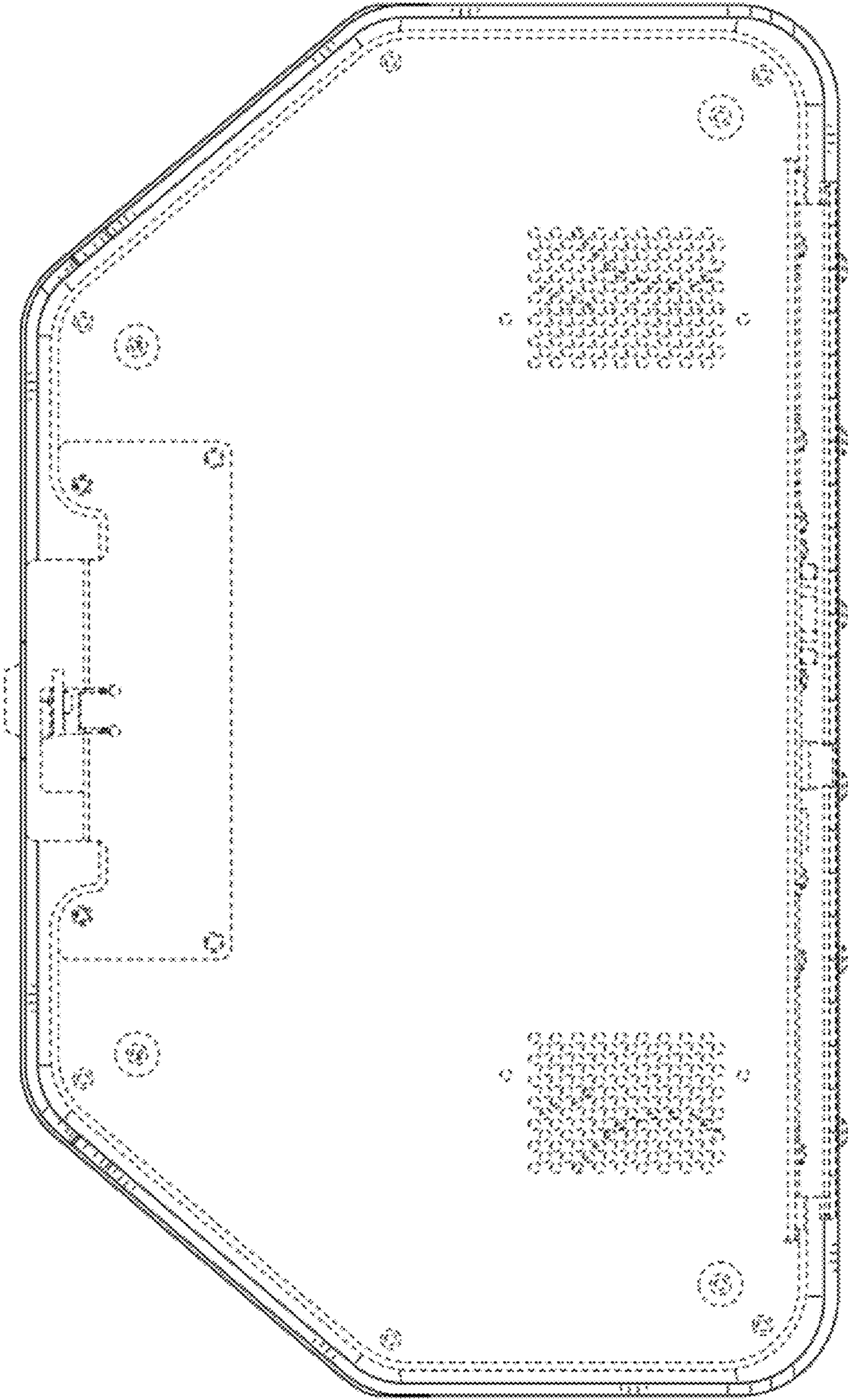

FIG. 7