



US00D663941S

(12) **United States Design Patent**
James

(10) **Patent No.:** **US D663,941 S**
(45) **Date of Patent:** **** Jul. 24, 2012**

(54) **SUPPLEMENTAL PADDED SHOE TONGUE**

(76) Inventor: **Dalene T. James**, Las Vegas, NV (US)

(**) Term: **14 Years**

(21) Appl. No.: **29/407,701**

(22) Filed: **Dec. 1, 2011**

(51) **LOC (9) Cl.** **02-99**

(52) **U.S. Cl.** **D2/975**

(58) **Field of Classification Search** D2/902,
D2/906-908, 843, 944, 969, 946, 975; 36/113,
36/114, 126-131, 54

See application file for complete search history.

(56) **References Cited**

U.S. PATENT DOCUMENTS

260,854	A *	7/1882	Earle	36/54
6,128,837	A *	10/2000	Huang	36/54
6,408,542	B1 *	6/2002	Shepherd	36/54
D499,877	S *	12/2004	Mark	D2/975
6,839,985	B2 *	1/2005	Bettiol	36/54
6,993,860	B2 *	2/2006	Bettiol	36/54
D550,948	S *	9/2007	Pelsue	D2/975
7,316,082	B2 *	1/2008	Hernandez Martinez-Portillo et al.	36/54

7,685,739	B2	3/2010	Aveni et al.	
7,770,308	B2	8/2010	Leoncini	
7,941,944	B2 *	5/2011	Cagliari 36/54
2002/0029494	A1	3/2002	Small	
2002/0139009	A1	10/2002	Mark	
2002/0170205	A1	11/2002	Shepherd	

* cited by examiner

Primary Examiner — Dominic Simone

(57) **CLAIM**

The ornamental design for a supplemental padded shoe tongue, as shown and described.

DESCRIPTION

FIG. 1 is a top plan view of a supplemental padded shoe tongue showing my new design; FIG. 2 is a bottom plan view thereof; FIG. 3 is a right elevation view thereof, the opposite side being a mirror image of the shown; FIG. 4 is a front elevation view thereof; FIG. 5 is a rear elevation view thereof; and, FIG. 6 is an isometric view thereof. The broken lines in FIG. 6 of the drawings depict an athletic shoe as environmental subject matter only and form no part of the claimed design.

1 Claim, 5 Drawing Sheets

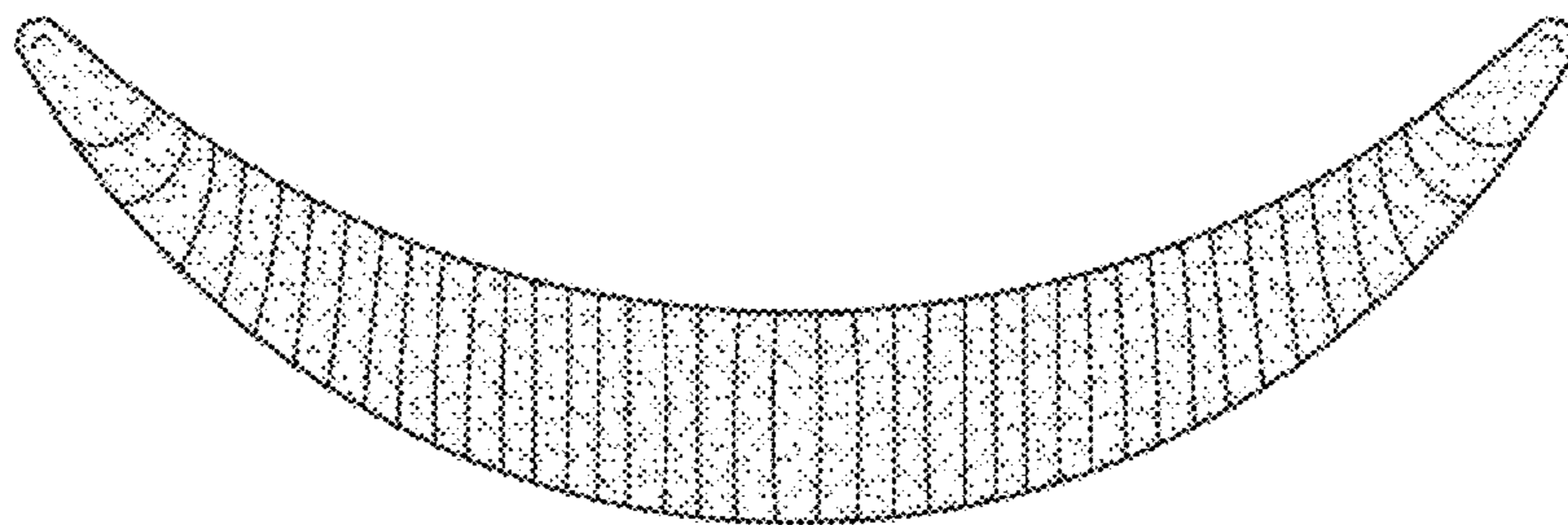
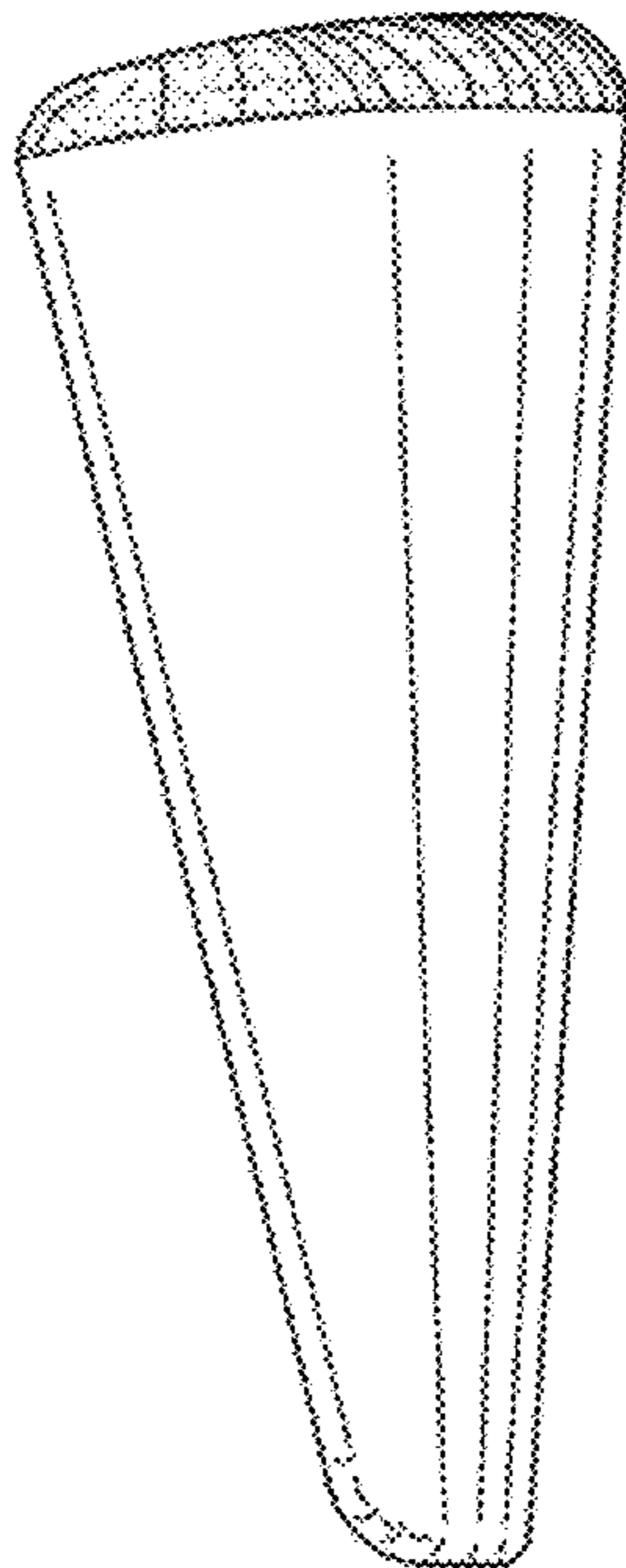

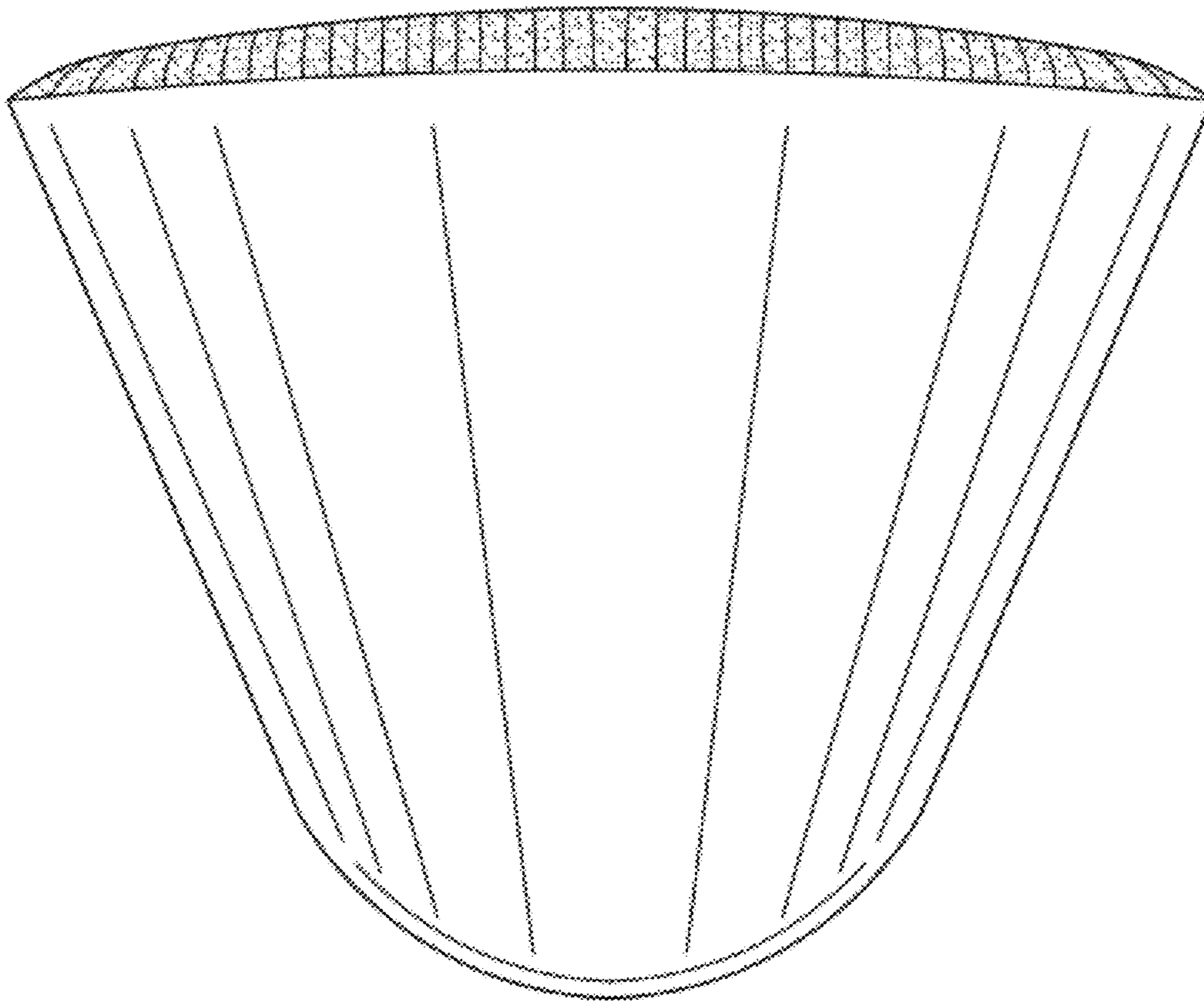

FIG. 1

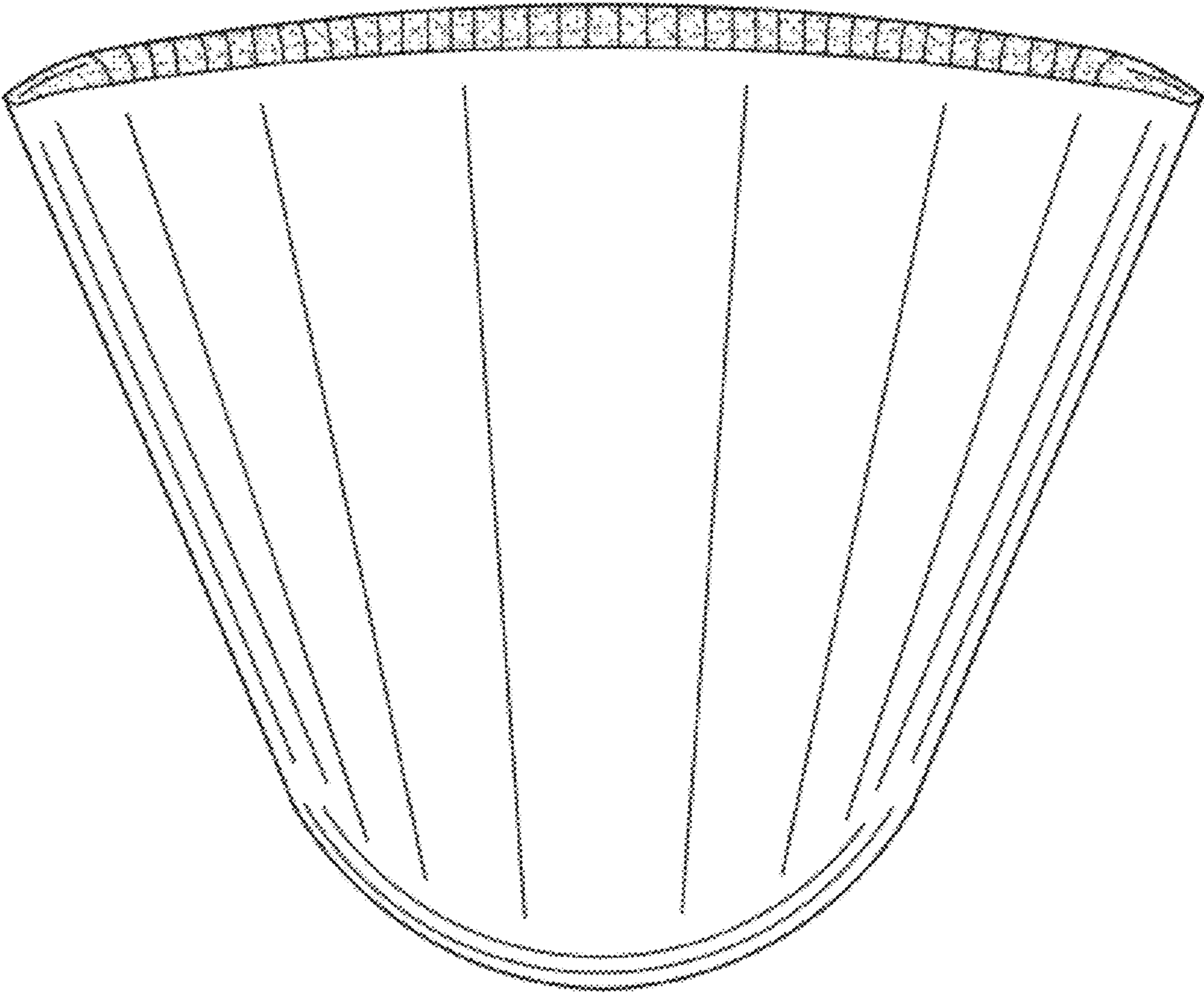

FIG. 2

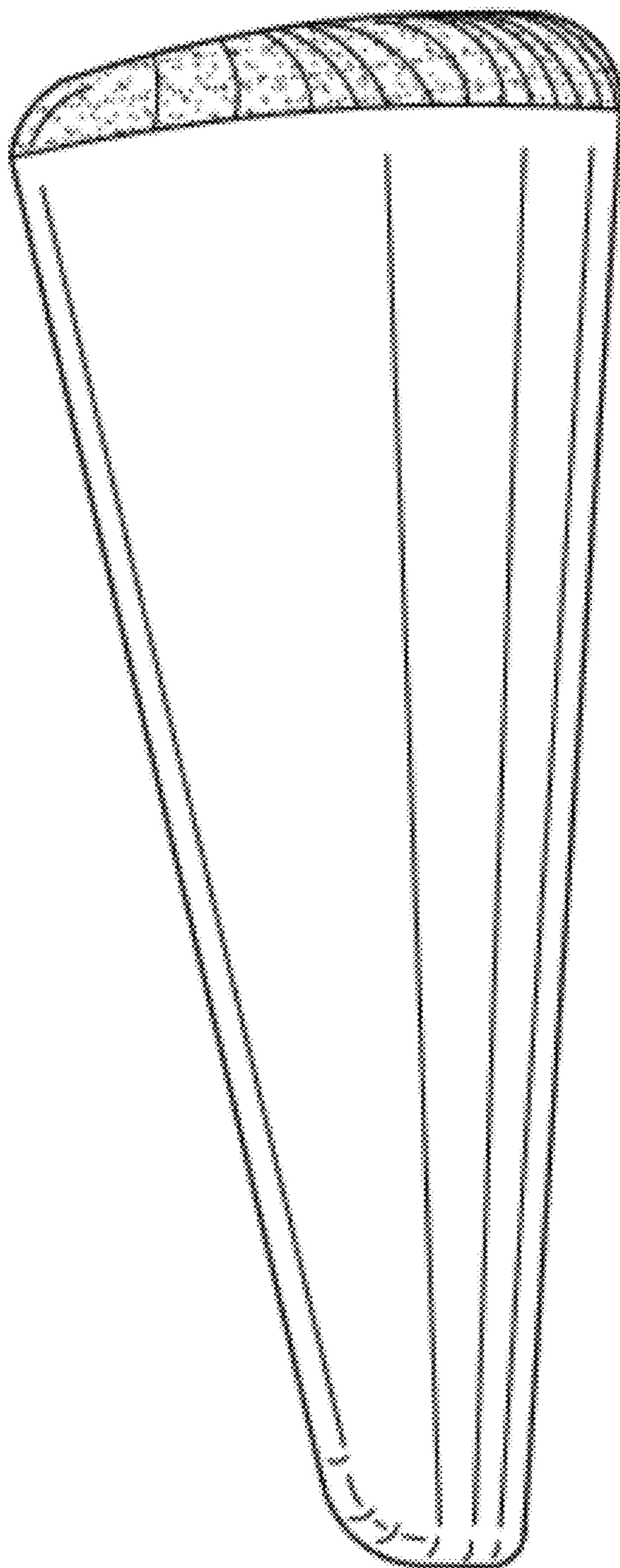

FIG. 3

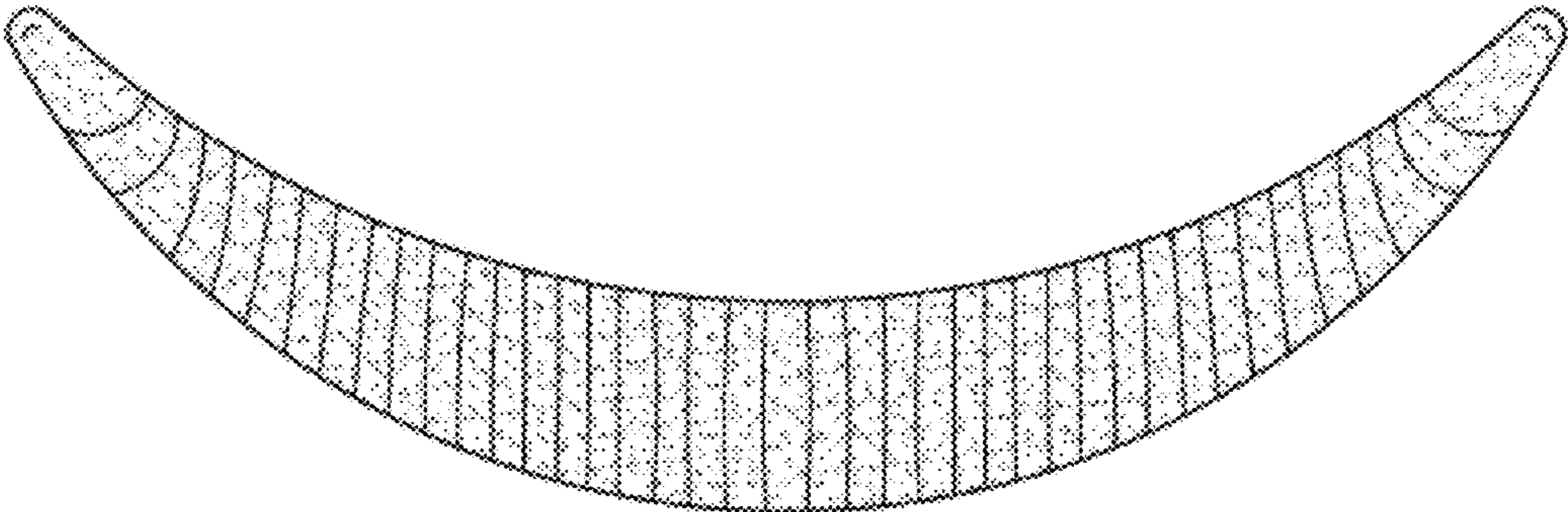

FIG. 4

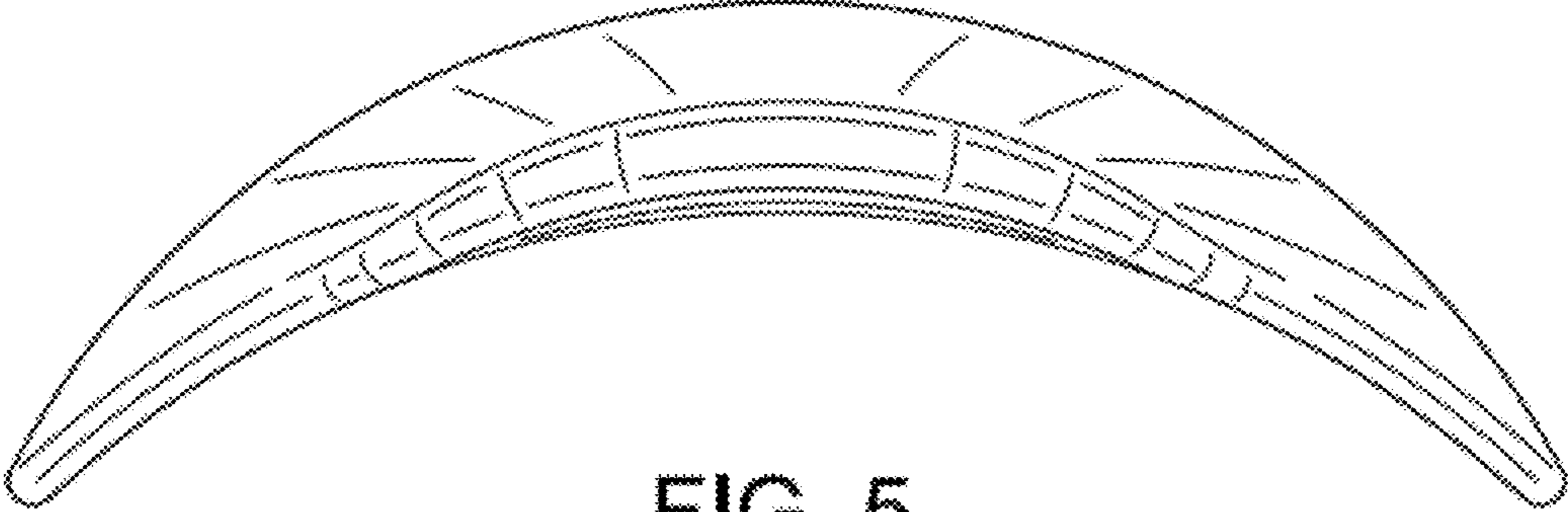

FIG. 5

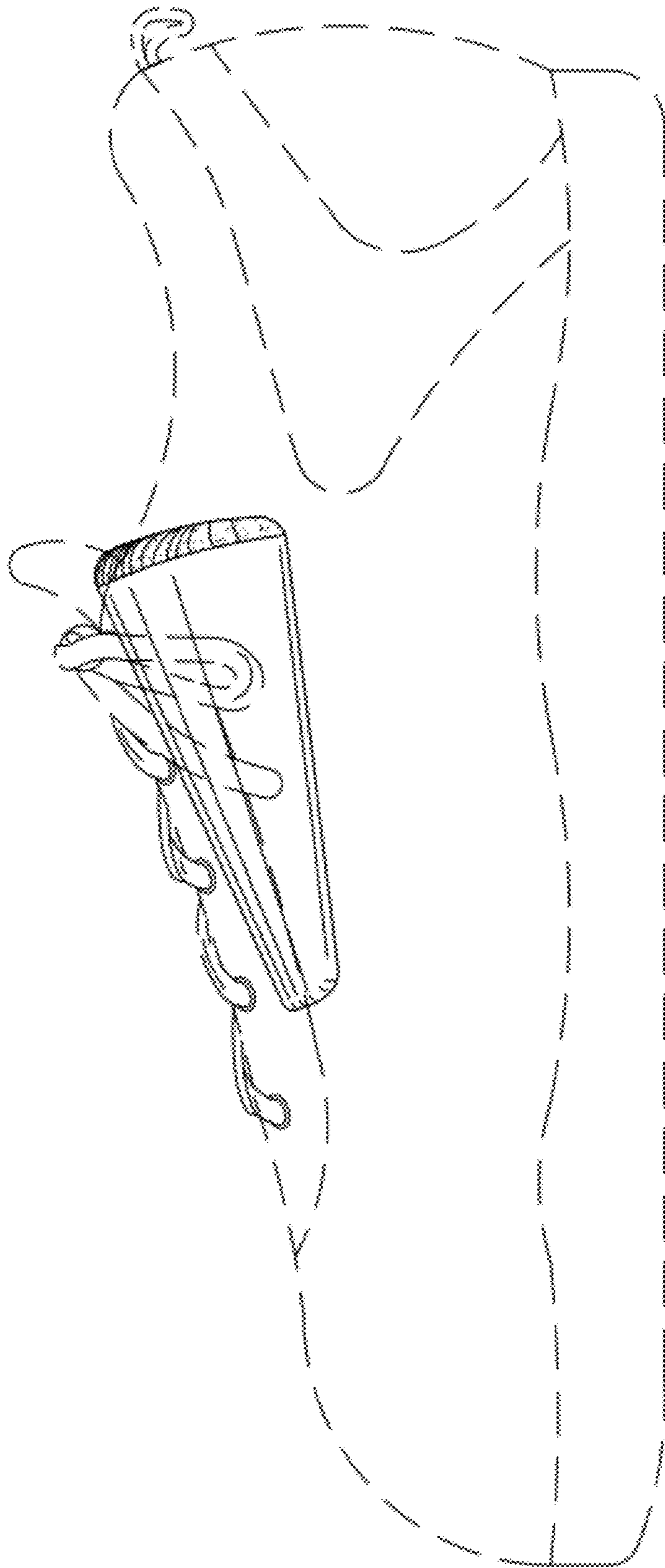

FIG. 6