



US00D663826S

(12) **United States Design Patent**
Browder

(10) **Patent No.:** **US D663,826 S**
(45) **Date of Patent:** **** Jul. 17, 2012**

(54) **COVER FOR LIGHT AND/OR FRAGRANCE
EMITTER**

(75) Inventor: **John Browder**, Argyle, TX (US)

(73) Assignee: **IDC Enchanted Lighting Company,
LLC**, Roanoke, TX (US)

(**) Term: **14 Years**

(21) Appl. No.: **29/411,665**

(22) Filed: **Jan. 25, 2012**

(51) **LOC (9) Cl.** **28-99**

(52) **U.S. Cl.** **D23/367**

(58) **Field of Classification Search** D23/355-369;
D28/5, 6; 261/DIG. 17, DIG. 42, DIG. 65,
261/DIG. 88, DIG. 89; 392/386, 390, 394,
392/395; 239/34, 44, 53, 55, 56, 326; D26/14,
D26/17, 98, 9, 22, 24; D11/131.1; D7/509,
D7/522, 524, 537

See application file for complete search history.

(56) **References Cited**

U.S. PATENT DOCUMENTS

D242,641 S * 12/1976 Neville D21/623
D314,992 S * 2/1991 Spangenberg D21/623
D408,872 S * 4/1999 Frederiksen D21/623

D410,076 S * 5/1999 Chen D23/367
D415,063 S * 10/1999 Wims et al. D11/121
D429,366 S * 8/2000 Lin D26/94
D470,549 S * 2/2003 Lai D21/623
D485,919 S * 1/2004 Yu D26/26
D486,252 S * 2/2004 Yu D26/26
D559,726 S * 1/2008 Garrison D11/121
D580,079 S * 11/2008 van der Lande D26/47

* cited by examiner

Primary Examiner — Sandra Snapp

(74) *Attorney, Agent, or Firm* — Brian Harris

(57) **CLAIM**

The ornamental design for a cover for light and/or fragrance emitter, as shown and described.

DESCRIPTION

FIG. 1 is a perspective view of a cover for light and/or fragrance emitter showing my new design;
FIG. 2 is a front view thereof;
FIG. 3 is left side view thereof;
FIG. 4 is a right side view thereof;
FIG. 5 is a back view thereof;
FIG. 6 is a top view thereof; and,
FIG. 7 is a bottom view thereof.

The broken lines form no part of the claimed design.

1 Claim, 6 Drawing Sheets

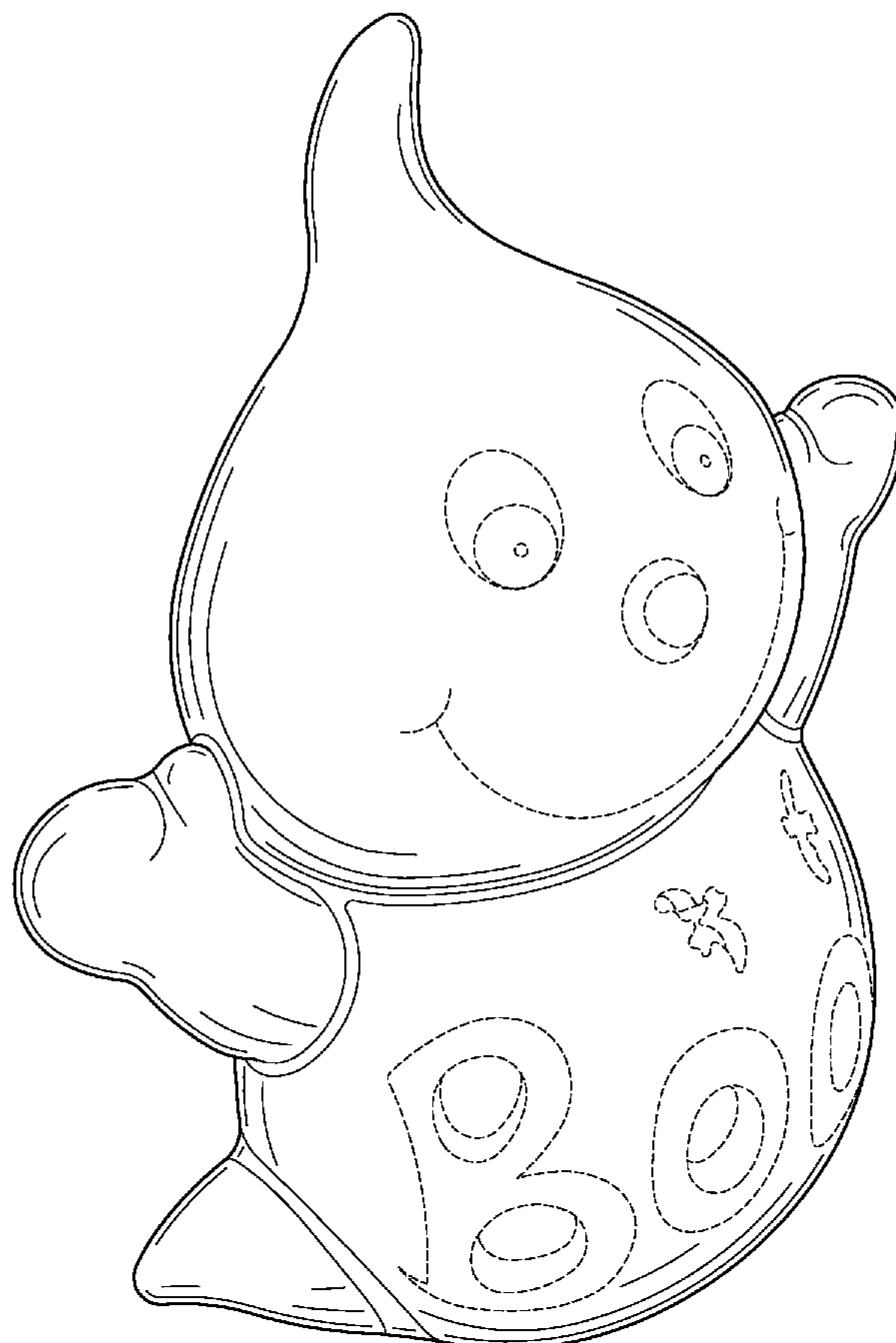

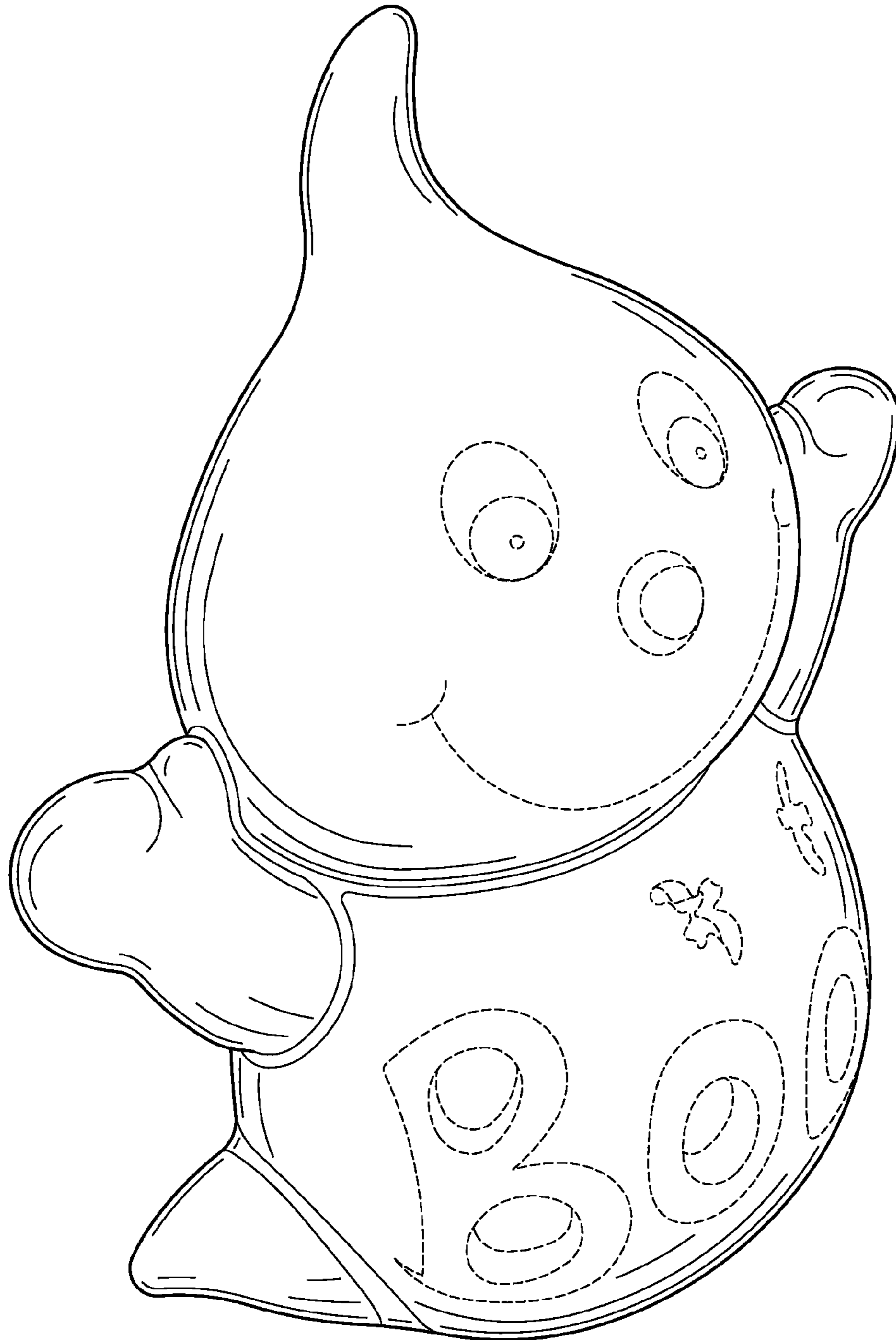

FIG. 1

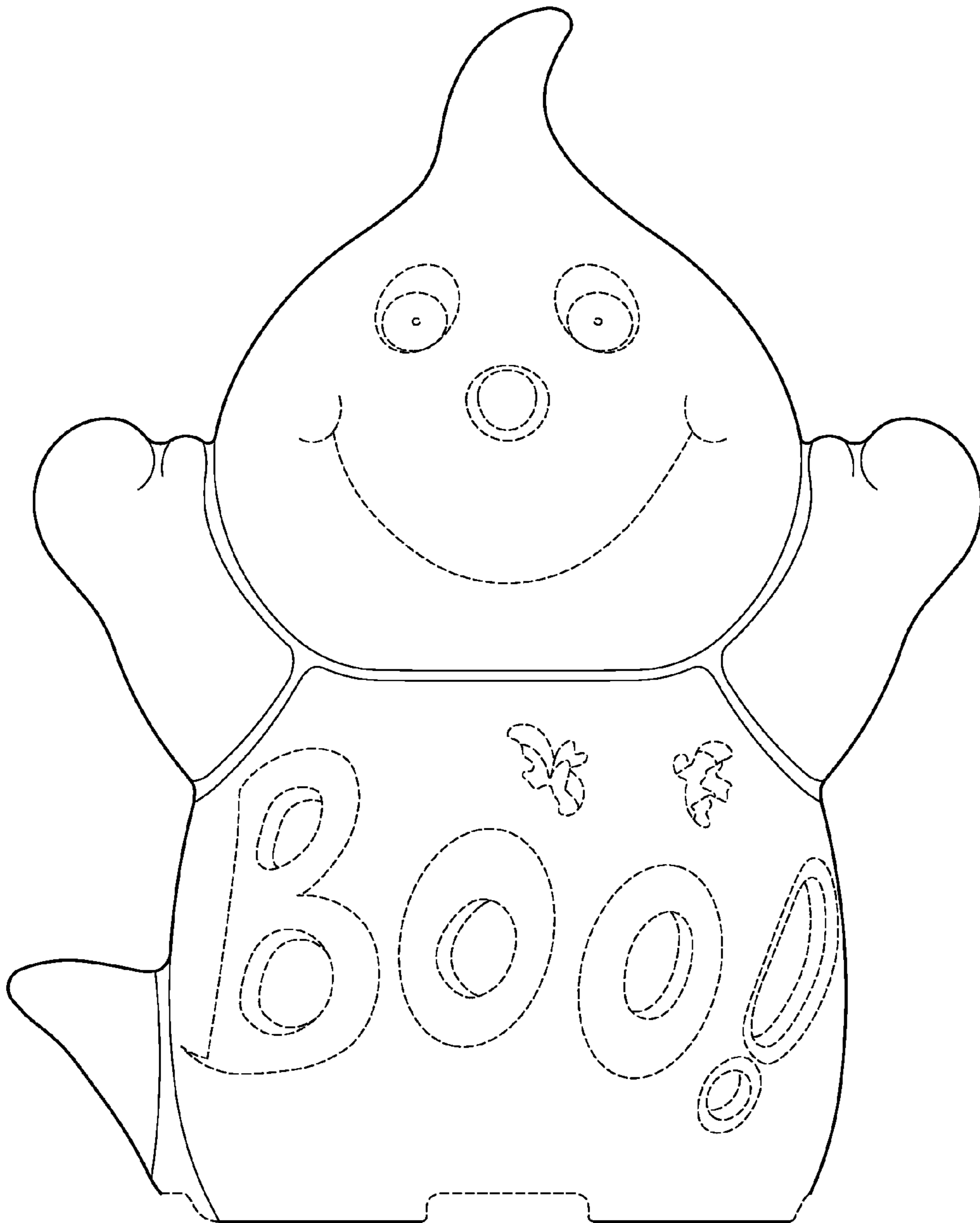

FIG. 2

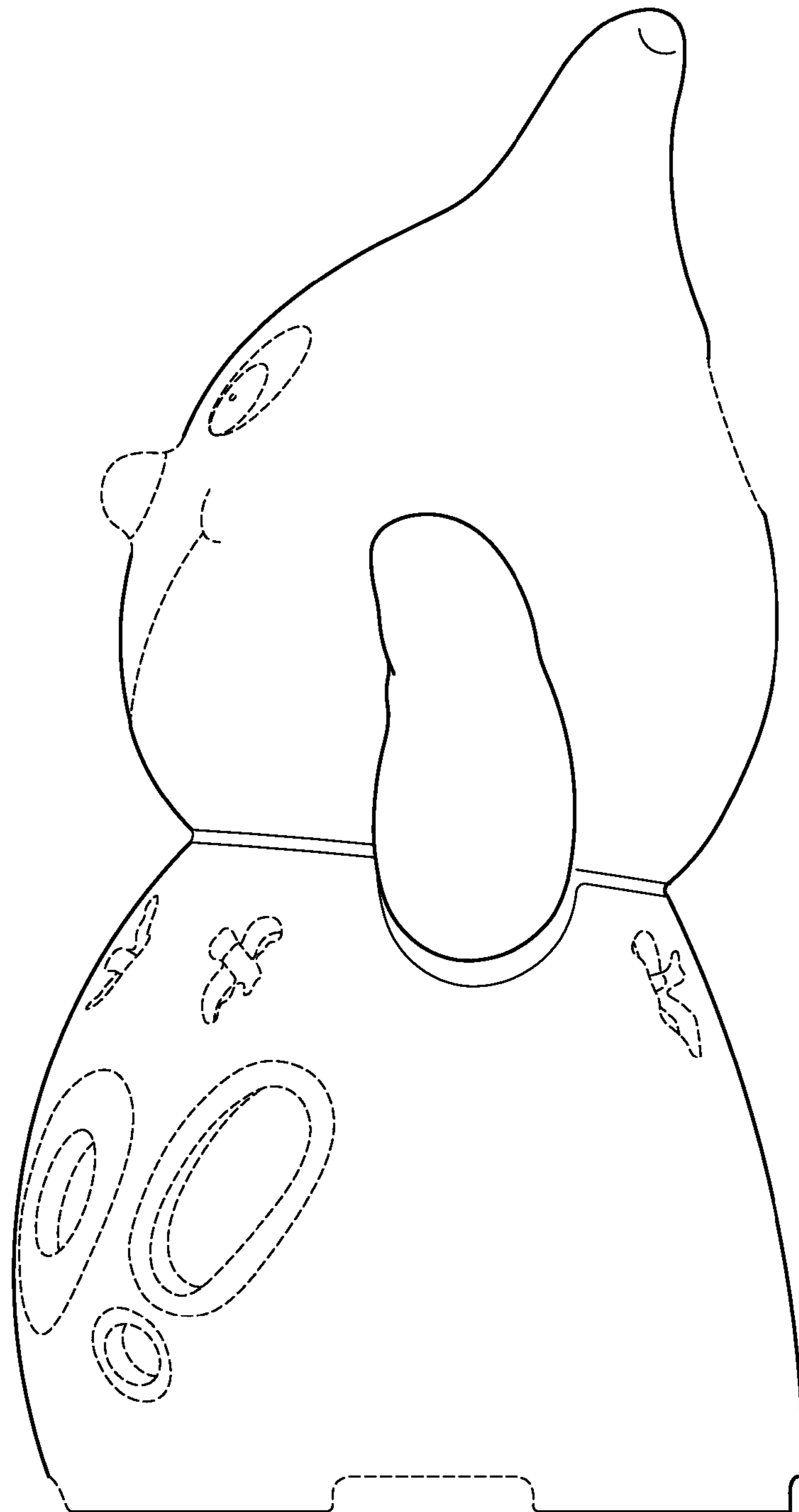

FIG. 3

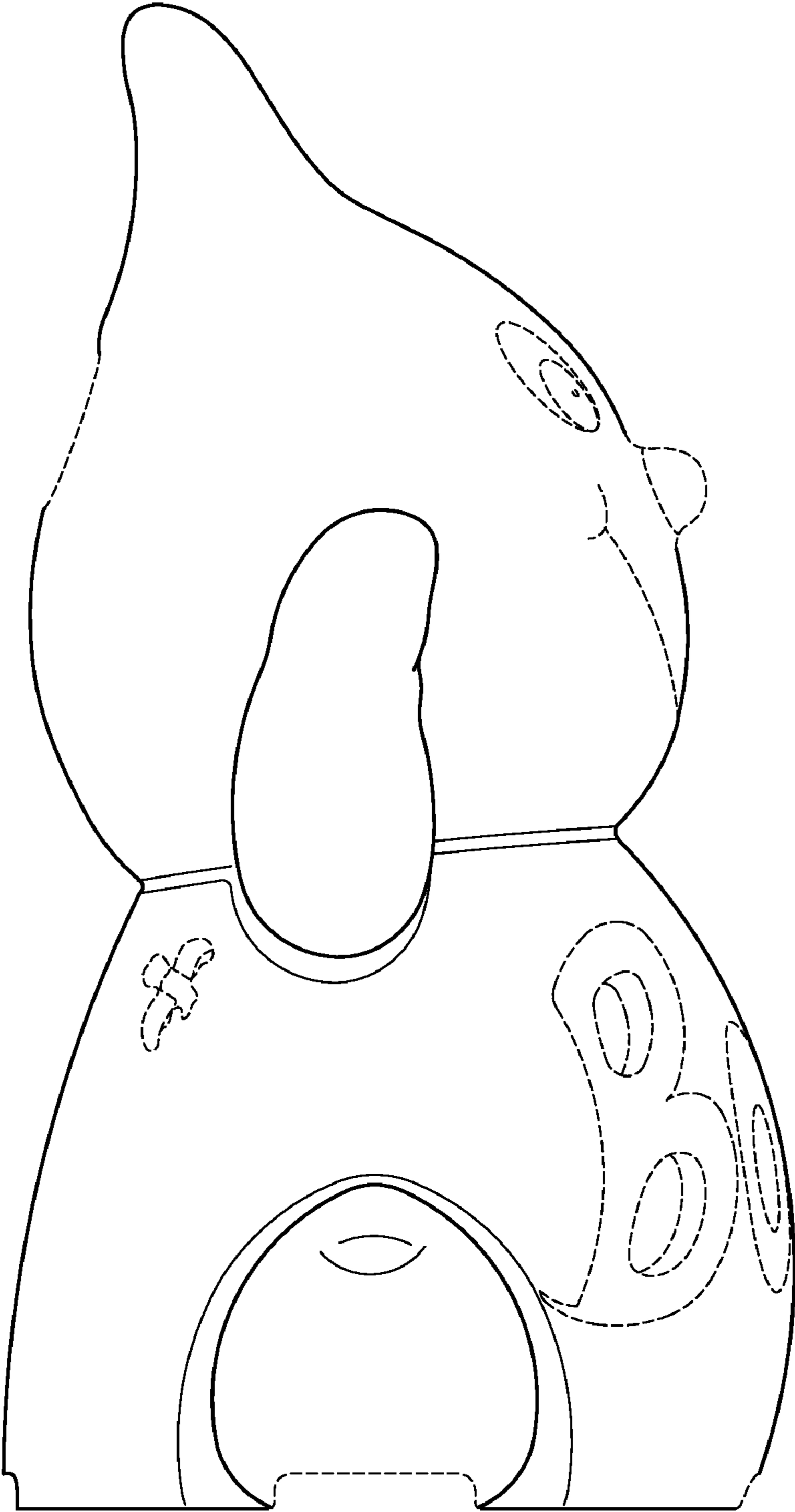

FIG. 4

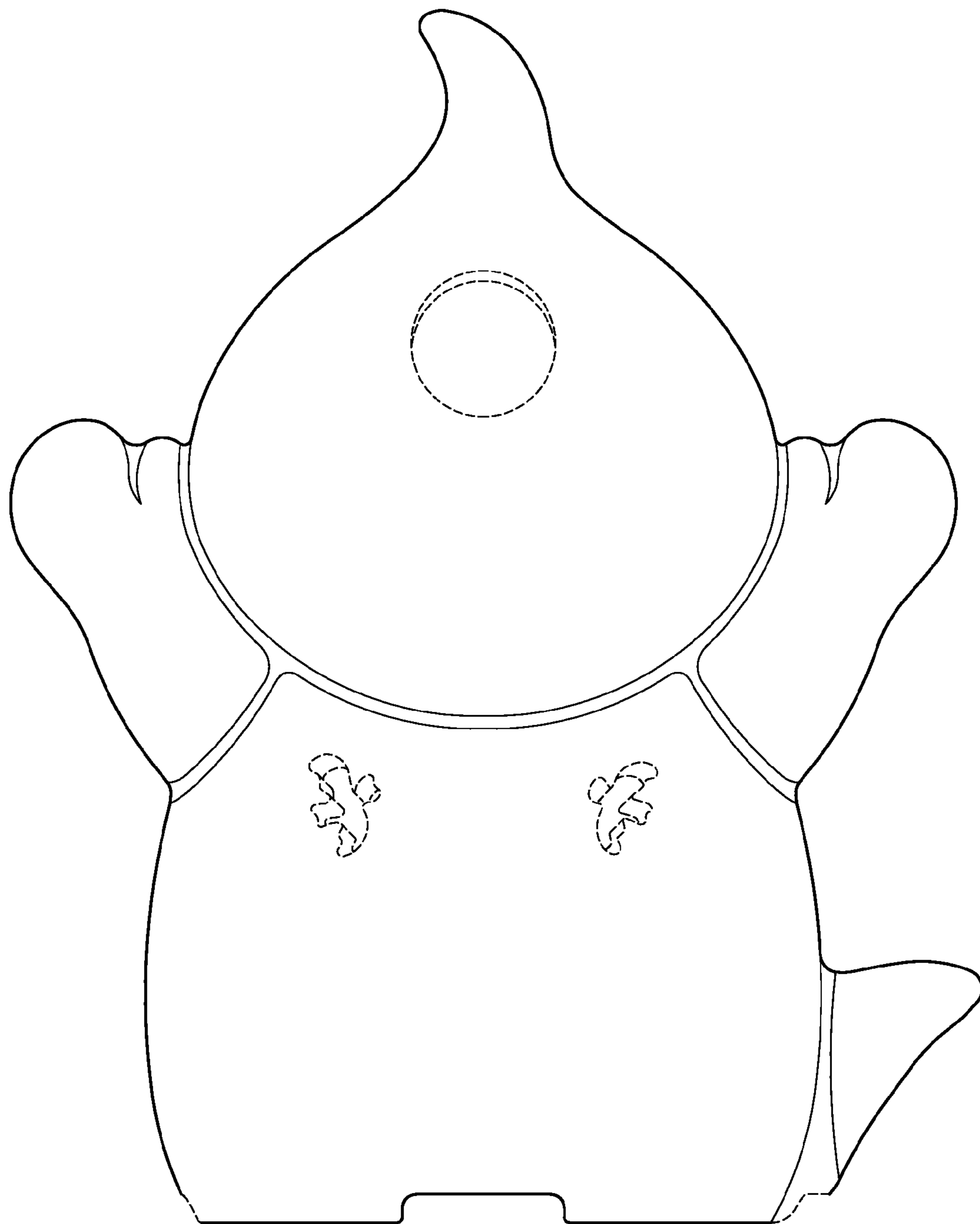

FIG. 5

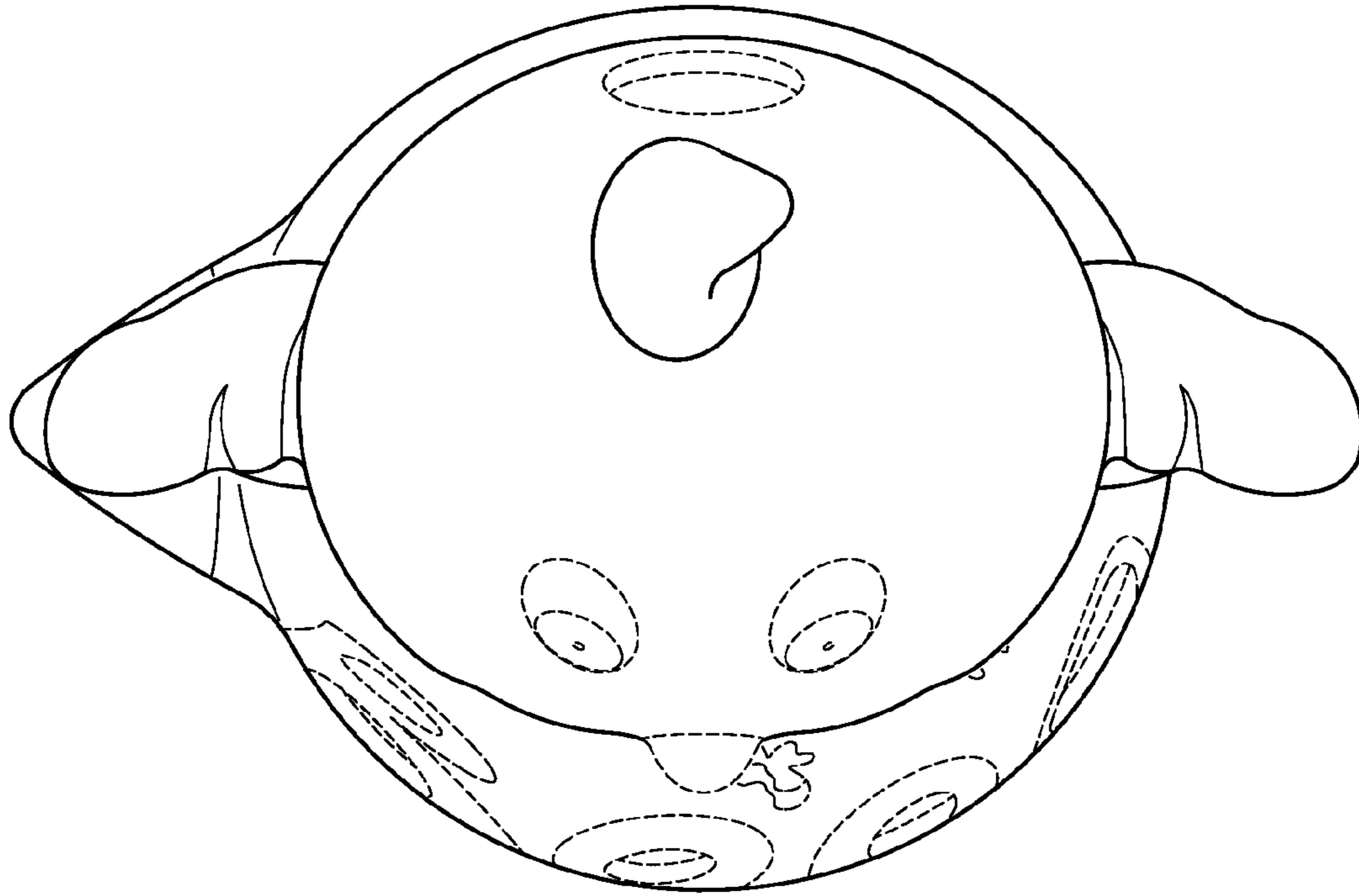

FIG. 6

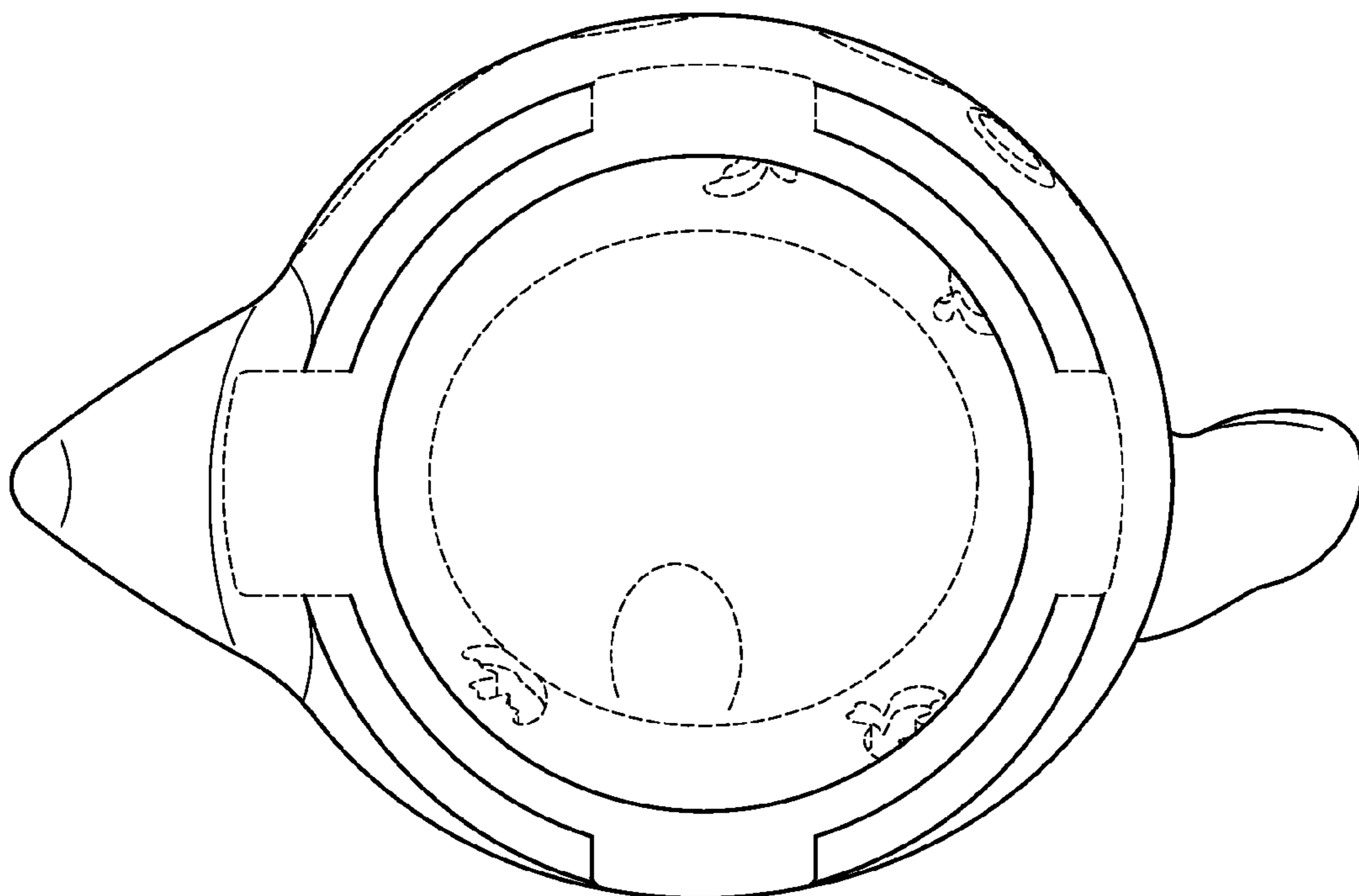

FIG. 7