



US00D663821S

(12) **United States Design Patent**  
**Browder**

(10) **Patent No.:** **US D663,821 S**  
(45) **Date of Patent:** **\*\* Jul. 17, 2012**

- (54) **COVER FOR LIGHT AND/OR FRAGRANCE EMITTER**
- (75) Inventor: **John Browder**, Argyle, TX (US)
- (73) Assignee: **IDC Enchanted Lighting Company, LLC**, Roanoke, TX (US)
- (\*\*) Term: **14 Years**
- (21) Appl. No.: **29/408,829**
- (22) Filed: **Dec. 16, 2011**
- (51) **LOC (9) Cl.** ..... **28-99**
- (52) **U.S. Cl.** ..... **D23/366**
- (58) **Field of Classification Search** ..... D23/355-369;  
D28/5, 6; 261/DIG. 17, DIG. 42, DIG. 65,  
261/DIG. 88, DIG. 89; 392/386, 390, 394,  
392/395; 239/34, 44, 53, 55, 56, 326; D26/14,  
D26/17, 98  
See application file for complete search history.

D476,071 S *	6/2003	Farmer	.....	D23/367
D485,343 S *	1/2004	Wu	.....	D23/367
D512,137 S *	11/2005	Chen	.....	D23/367
D512,770 S *	12/2005	Wu	.....	D23/367
D517,187 S *	3/2006	Wu	.....	D23/367
D541,922 S *	5/2007	Wefler et al.	.....	D23/366
D542,400 S *	5/2007	Wefler	.....	D23/366
D546,931 S *	7/2007	Wefler	.....	D23/366
7,318,659 B2 *	1/2008	Demarest et al.	.....	362/253
7,476,002 B2 *	1/2009	Wolf et al.	.....	362/231
7,484,860 B2 *	2/2009	Demarest et al.	.....	362/253
7,503,675 B2 *	3/2009	Demarest et al.	.....	362/253
7,520,635 B2 *	4/2009	Wolf et al.	.....	362/276
7,604,378 B2 *	10/2009	Wolf et al.	.....	362/253
7,618,151 B2 *	11/2009	Abbondanzio et al.	.....	362/96
7,643,734 B2 *	1/2010	Wefler	.....	392/395
7,687,744 B2 *	3/2010	Walter et al.	.....	219/505
7,932,482 B2 *	4/2011	Norwood et al.	.....	219/506
D650,547 S *	12/2011	Khan	.....	D99/5
2005/0195598 A1 *	9/2005	Dancs et al.	.....	362/231

\* cited by examiner

*Primary Examiner* — Sandra Snapp  
(74) *Attorney, Agent, or Firm* — Brian Harris

(56) **References Cited**

U.S. PATENT DOCUMENTS

D74,376 S *	2/1928	Katz	.....	D26/17
D130,991 S *	1/1942	Gray	.....	D26/17
D166,358 S *	4/1952	Shain	.....	D26/14
2,903,819 A *	9/1959	Barber et al.	.....	446/385
D195,009 S *	4/1963	Bergeron	.....	D9/448
3,246,409 A *	4/1966	Taylor et al.	.....	40/457
D245,531 S *	8/1977	Shiraishi	.....	D21/585
D253,097 S *	10/1979	Phelps	.....	D11/162
D336,332 S *	6/1993	Woolley	.....	D23/367
D402,844 S *	12/1998	Rosenstadt et al.	.....	D6/598
D406,717 S *	3/1999	Rosenstadt et al.	.....	D6/598
D417,356 S *	12/1999	Rosenstadt et al.	.....	D6/598
D428,647 S *	7/2000	Chen	.....	D23/367
D433,764 S *	11/2000	Dolan	.....	D26/84
D433,862 S *	11/2000	Rosenstadt et al.	.....	D6/598
D433,863 S *	11/2000	Rosenstadt et al.	.....	D6/598
D434,260 S *	11/2000	Rosenstadt et al.	.....	D6/598

(57) **CLAIM**

The ornamental design for a cover for light and/or fragrance emitter, as shown and described.

**DESCRIPTION**

FIG. 1 is a perspective view of a cover for light and/or fragrance emitter showing my new design;  
FIG. 2 is a front view thereof;  
FIG. 3 is a back view thereof;  
FIG. 4 is a left side view thereof;  
FIG. 5 is a right side view thereof;  
FIG. 6 is a top view thereof; and,  
FIG. 7 is a bottom view thereof.  
The broken lines shown in the drawings are for illustrative purposes only and form no part of the claimed design.

**1 Claim, 7 Drawing Sheets**

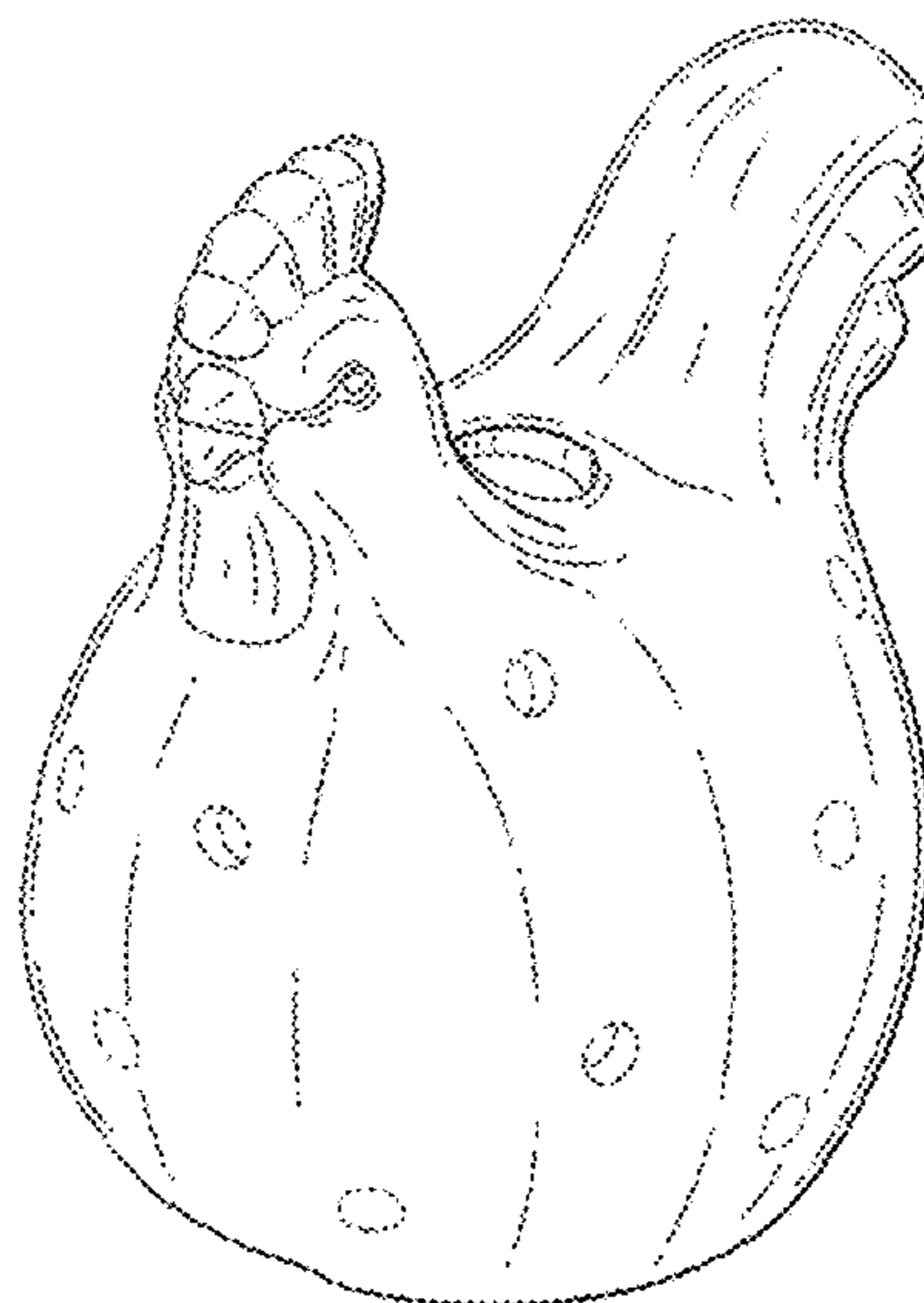



FIG. 1

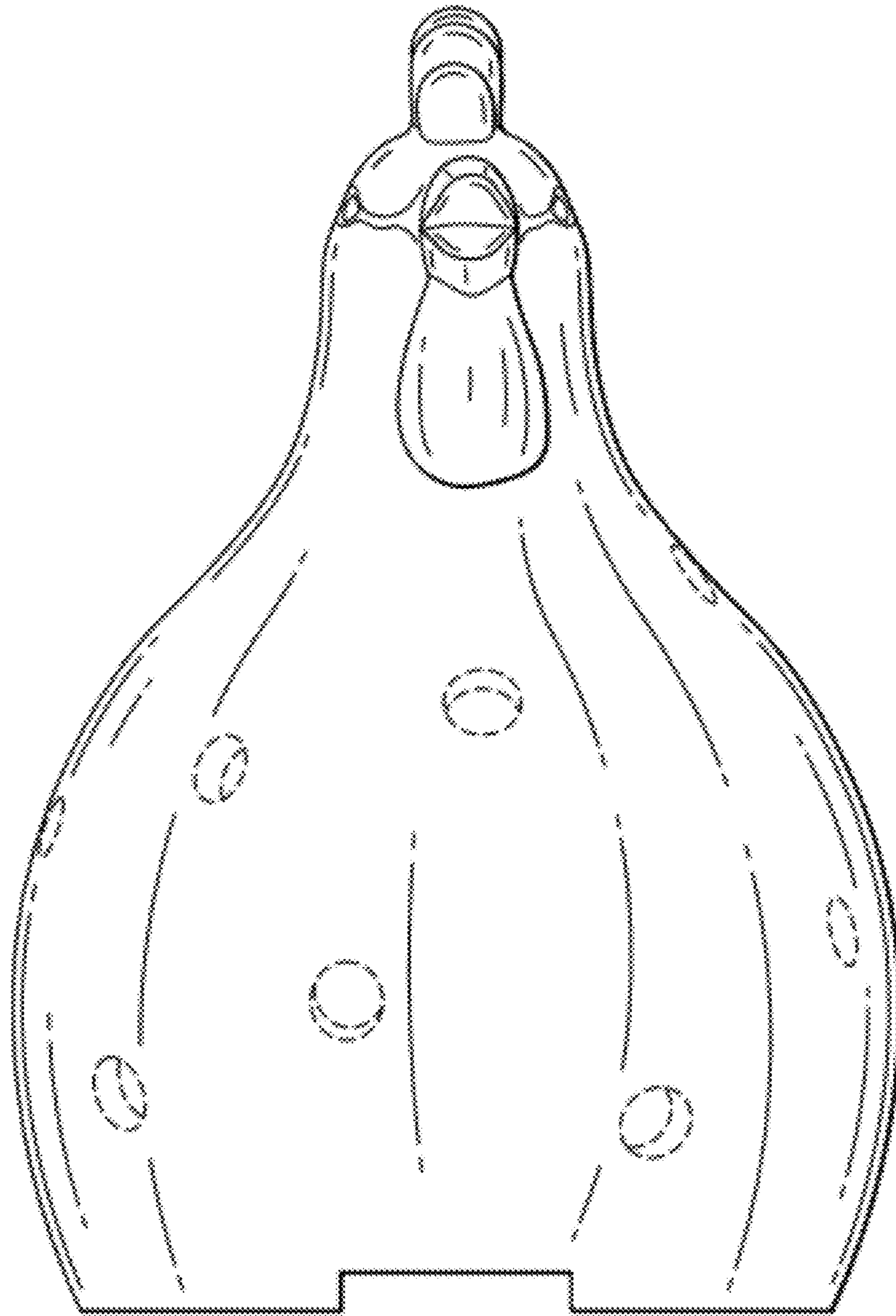

FIG. 2

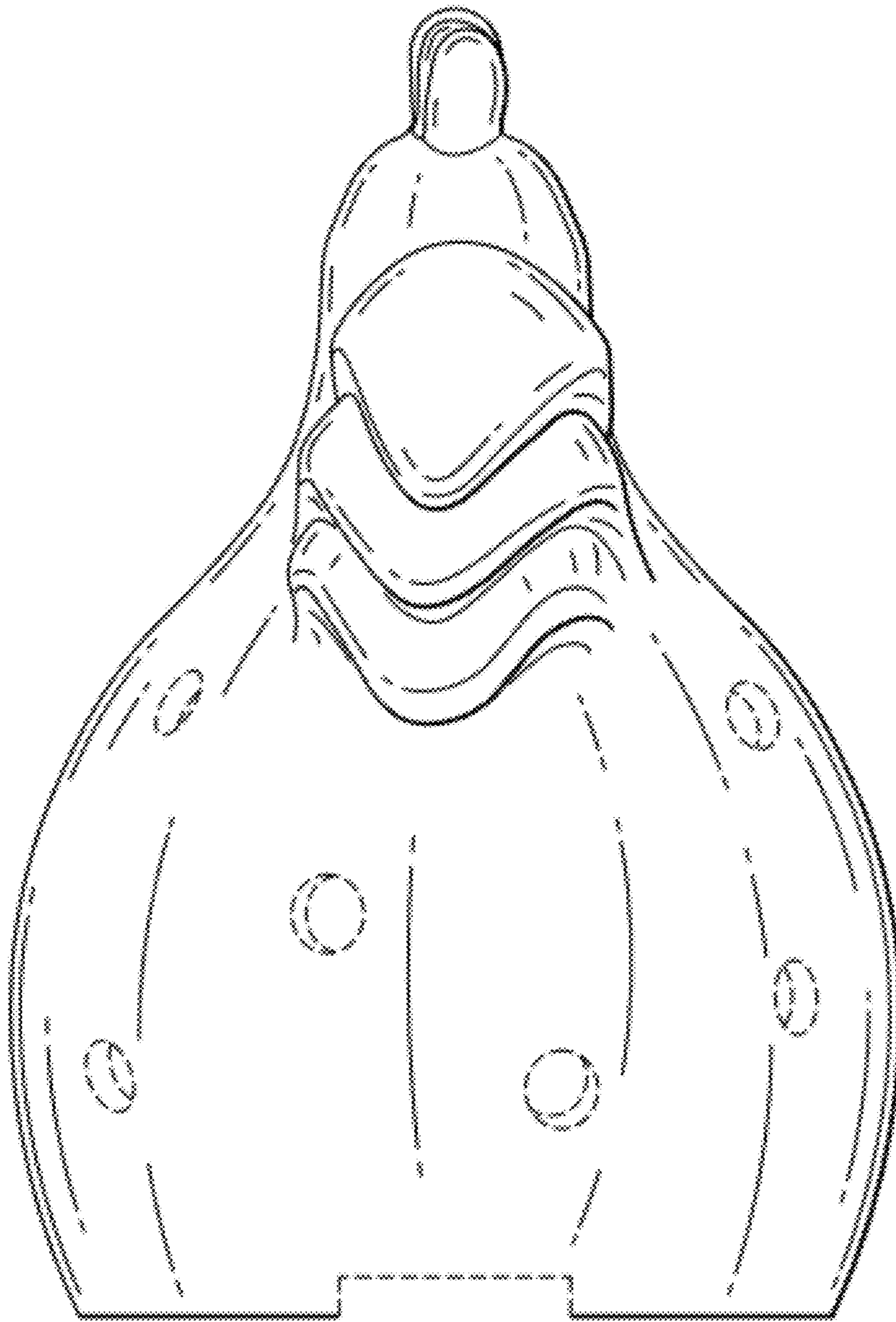

FIG. 3

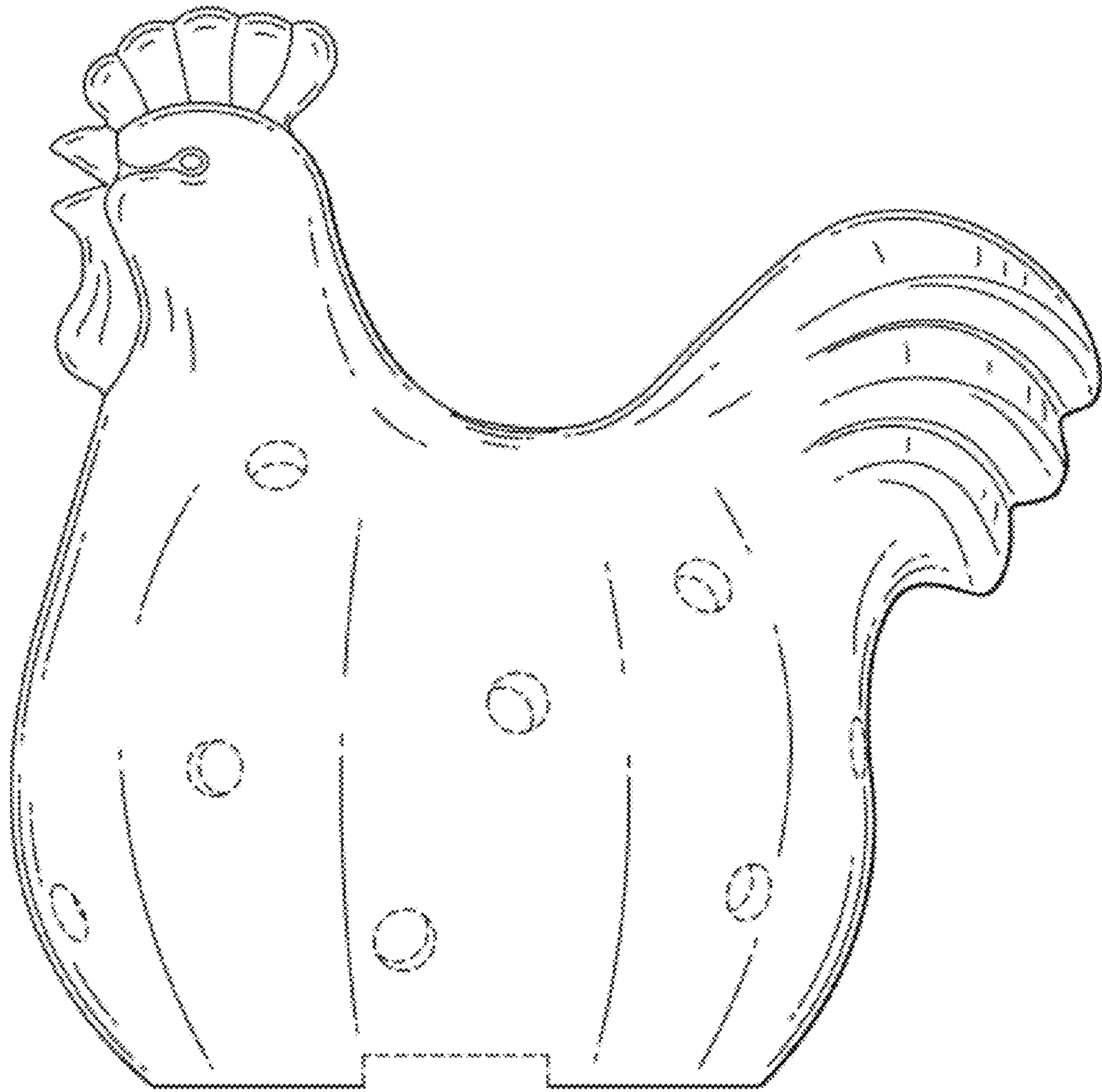

FIG. 4

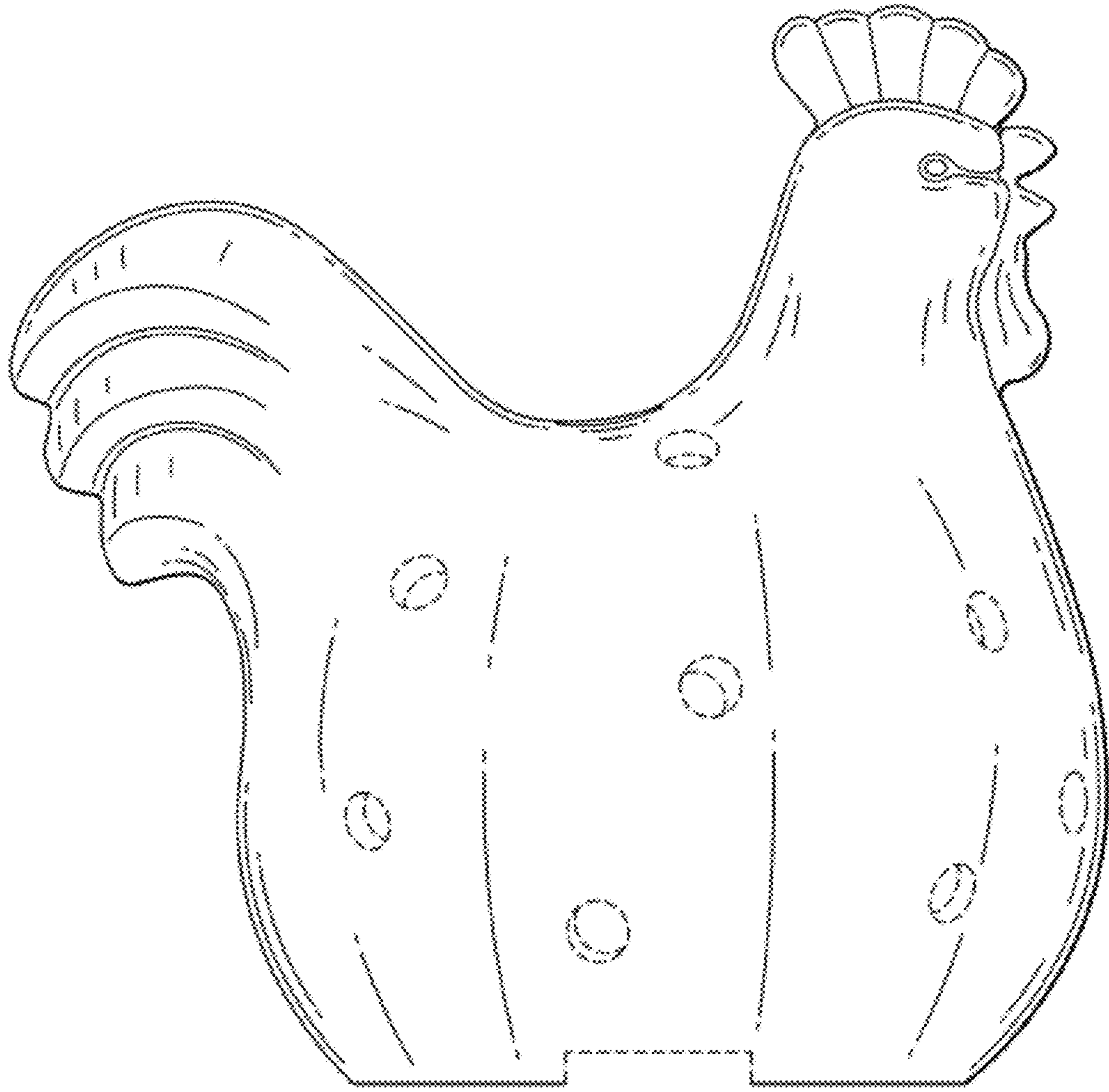

FIG. 5

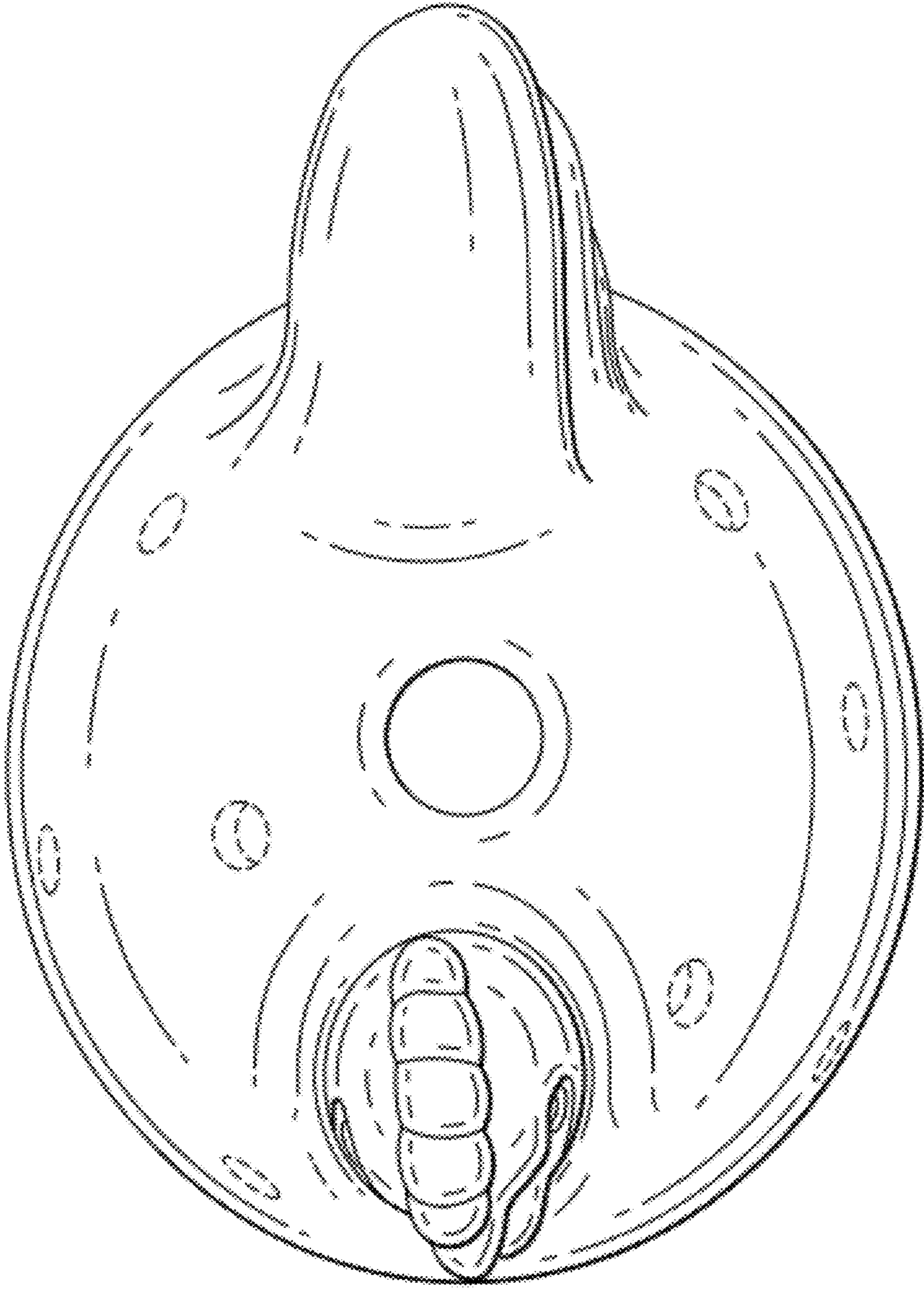

FIG. 6

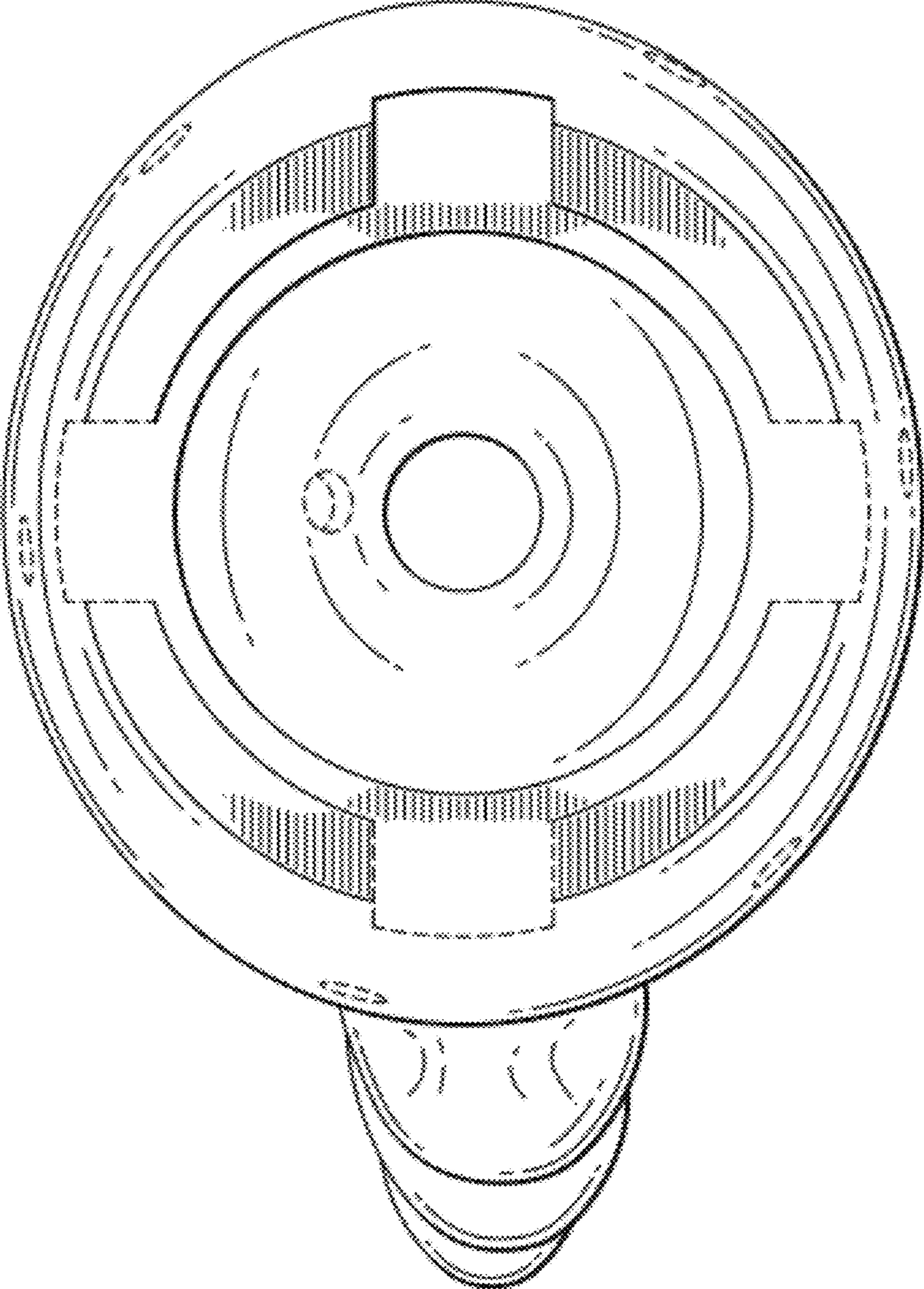

FIG. 7