



US00D663647S

(12) **United States Design Patent**
Magid et al.

(10) **Patent No.:** **US D663,647 S**
(45) **Date of Patent:** **** Jul. 17, 2012**

(54) **JEWELRY ELEMENT**

(75) Inventors: **Sarah Magid**, Brooklyn, NY (US);
Christine Corr, New York, NY (US)

(73) Assignee: **Henri Bendel, Inc.**, New York, NY (US)

(**) Term: **14 Years**

(21) Appl. No.: **29/395,135**

(22) Filed: **Dec. 1, 2011**

(51) **LOC (9) Cl.** **11-01**

(52) **U.S. Cl.** **D11/1; D11/79; D11/26**

(58) **Field of Classification Search** D11/26-39,
D11/4-5, 79-86; 63/15, 15.1-15.4, 15.45,
63/15.5, 15.6, 15.65, 15.7, 3, 12, 13
See application file for complete search history.

(56) **References Cited**

U.S. PATENT DOCUMENTS

289,912 A *	12/1883	Huleu	63/41
1,936,604 A *	11/1933	Moldenhauer	63/15
D138,882 S *	9/1944	Drell	D11/227
D170,661 S *	10/1953	Semensohn	D11/40
D387,300 S *	12/1997	Morrison	D11/40
D424,967 S *	5/2000	Perrin et al.	D11/28
D480,981 S *	10/2003	Pasquetti	D11/26
D563,257 S *	3/2008	Schumacher	D11/26

D619,003 S *	7/2010	Benoit-Gonin et al.	D9/453
D628,117 S *	11/2010	Speegle	D11/79
D631,382 S *	1/2011	Iacomucci	D11/26

* cited by examiner

Primary Examiner — Cathron Brooks

Assistant Examiner — Melanie Pellegrini

(74) *Attorney, Agent, or Firm* — Ward & Zinna, LLC

(57) **CLAIM**

The ornamental design for a jewelry element, as shown and described.

DESCRIPTION

FIG. 1 is a perspective view of the jewelry element according to the present invention;

FIG. 2 is a front view thereof;

FIG. 3 is a rear view thereof;

FIG. 4 is a left side view thereof;

FIG. 5 is a right side view thereof;

FIG. 6 is a top view thereof;

FIG. 7 is a bottom view thereof; and,

FIG. 8 is a front view of the jewelry element shown with alternate unclaimed environmental structure.

The broken lines shown in the drawings are included for the purpose of illustrating the environment of the design and form no part of the claimed design.

1 Claim, 7 Drawing Sheets

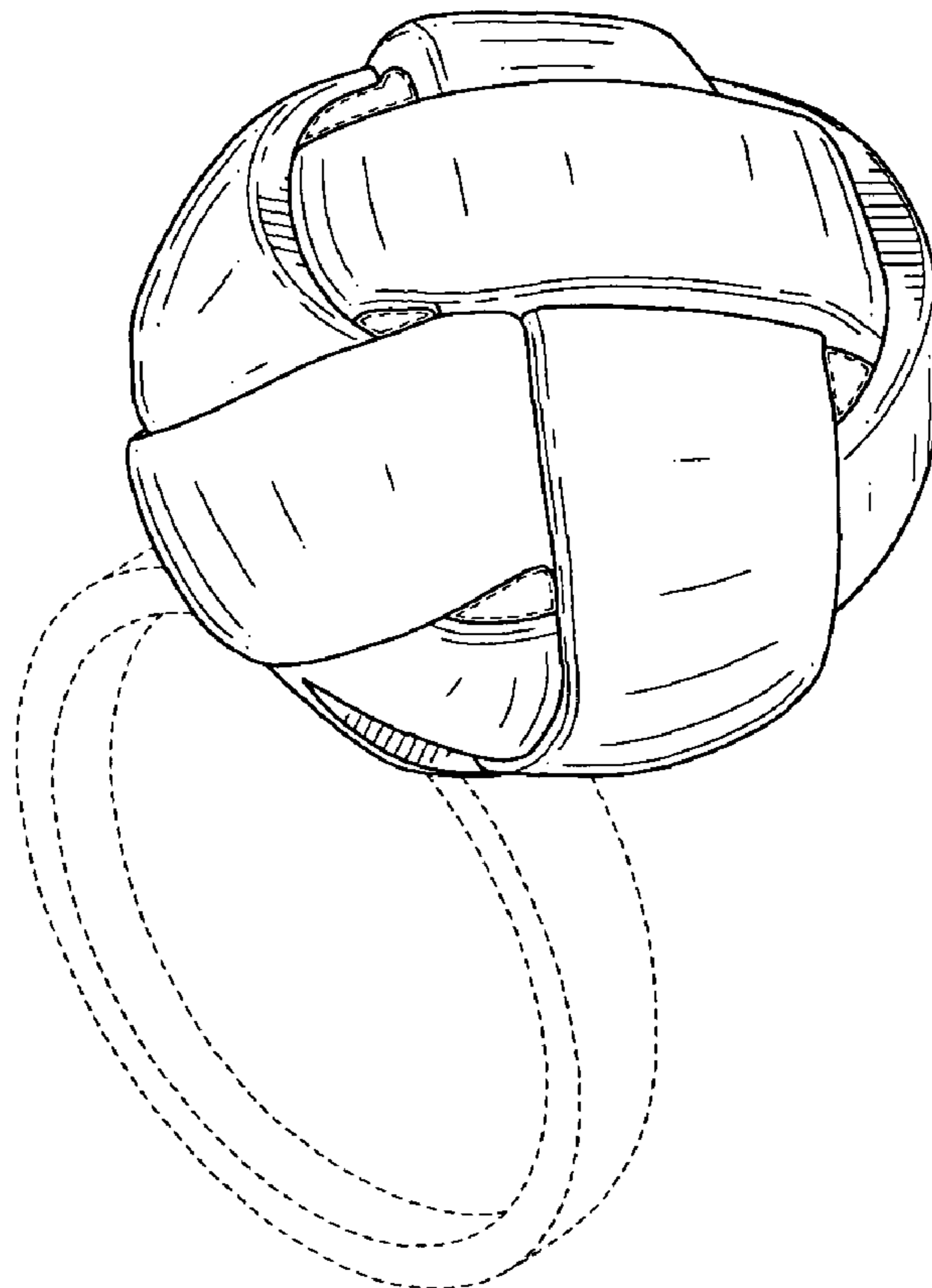

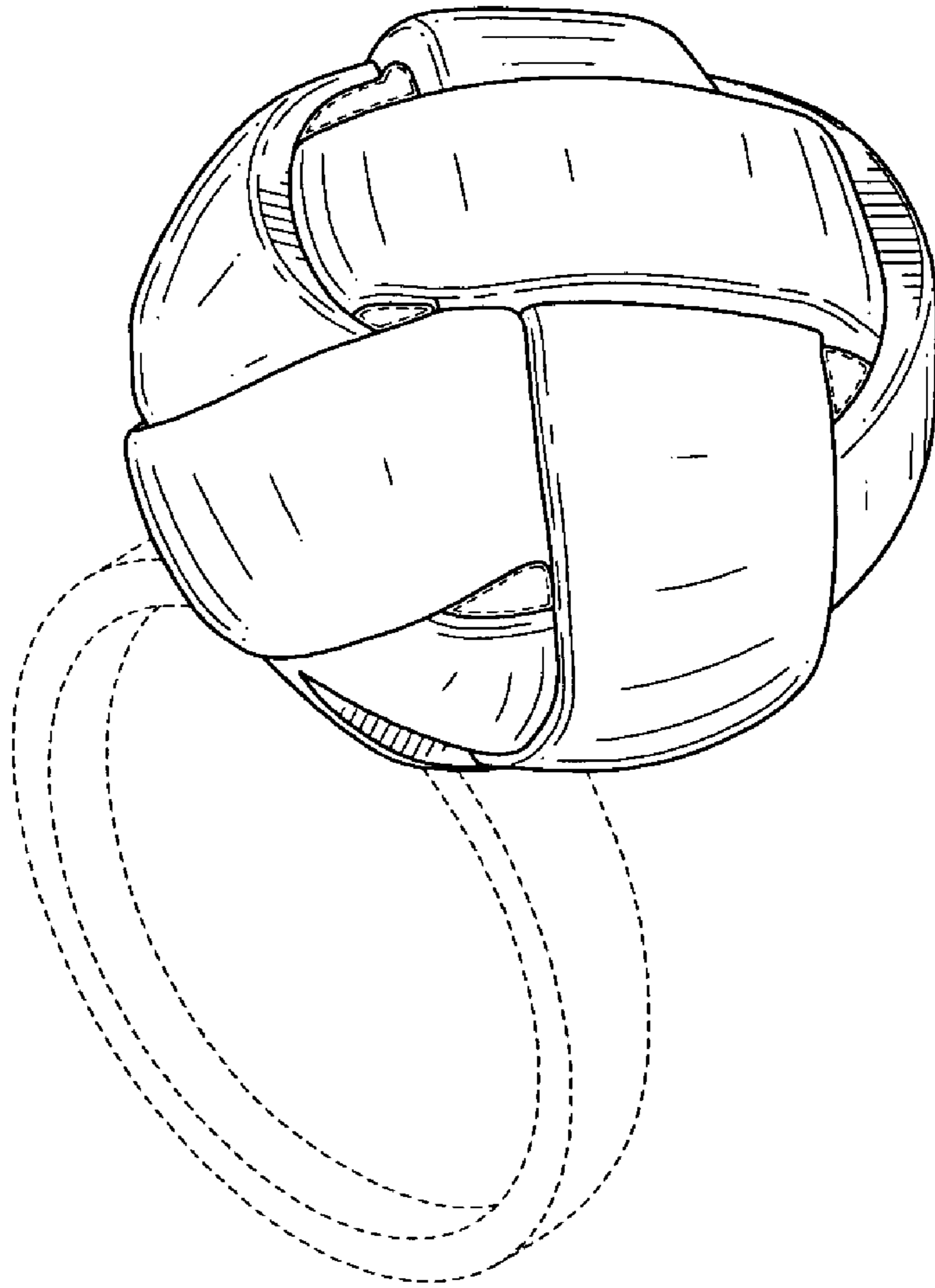

FIG. 1

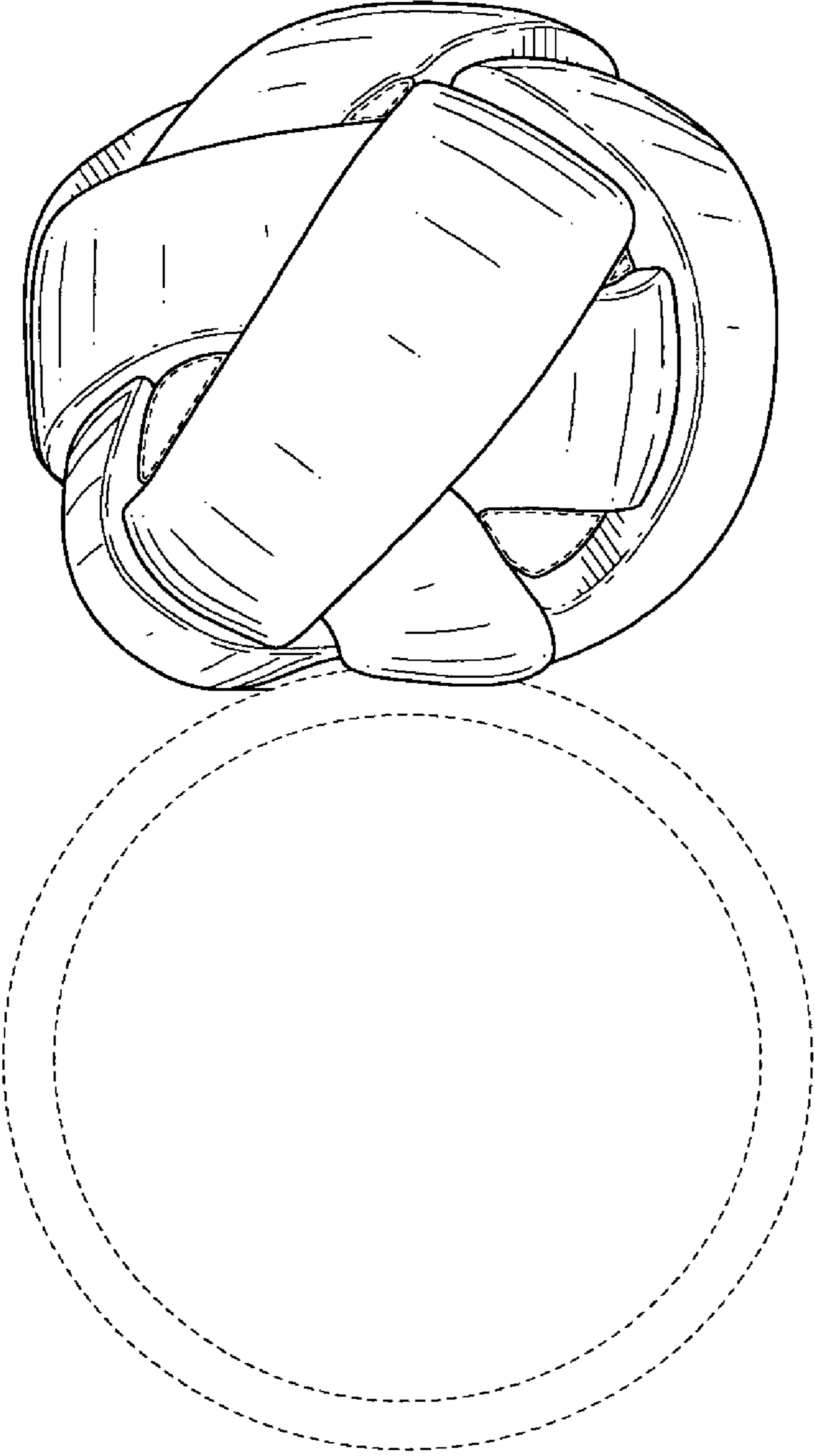

FIG. 2

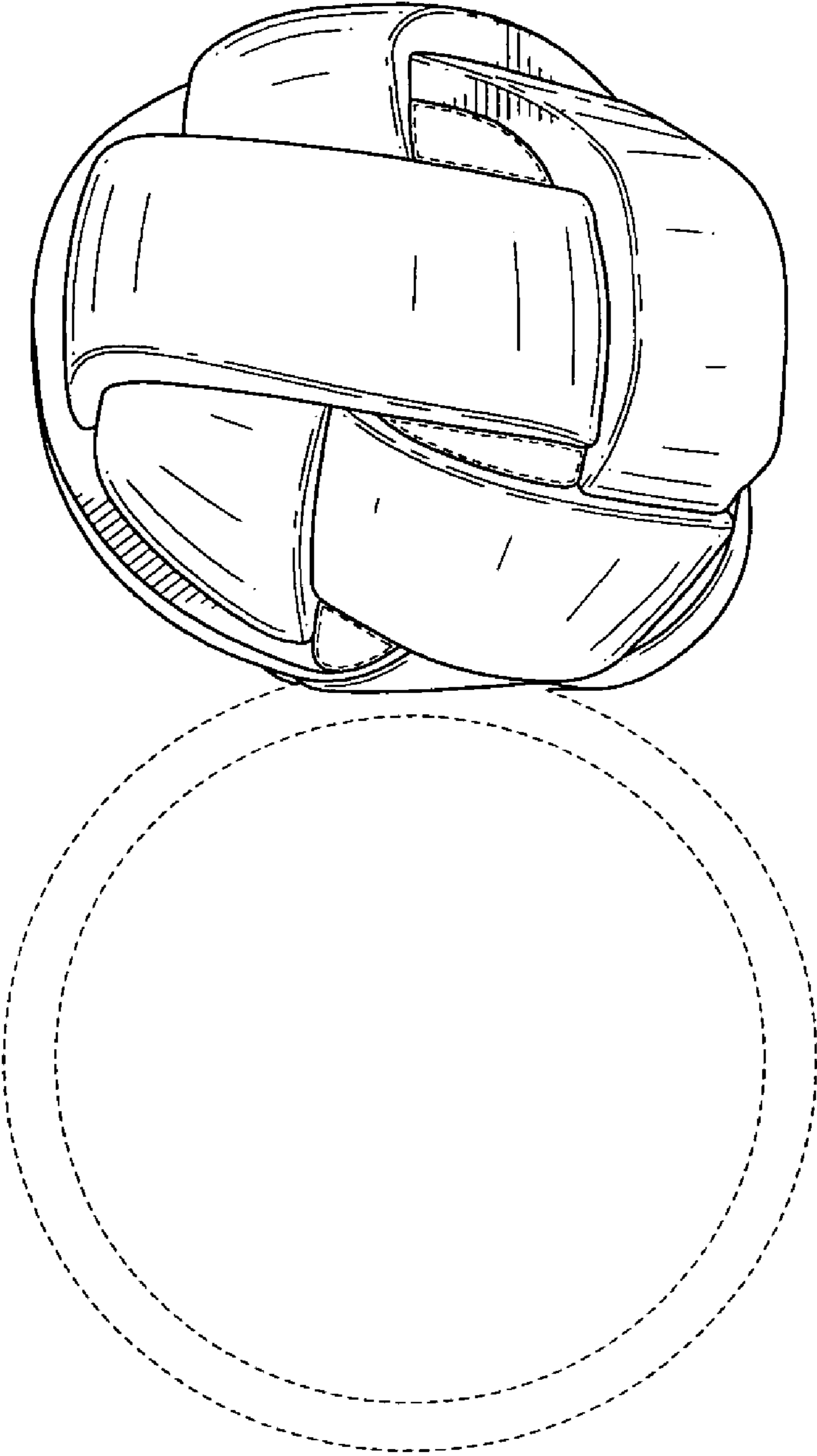

FIG. 3

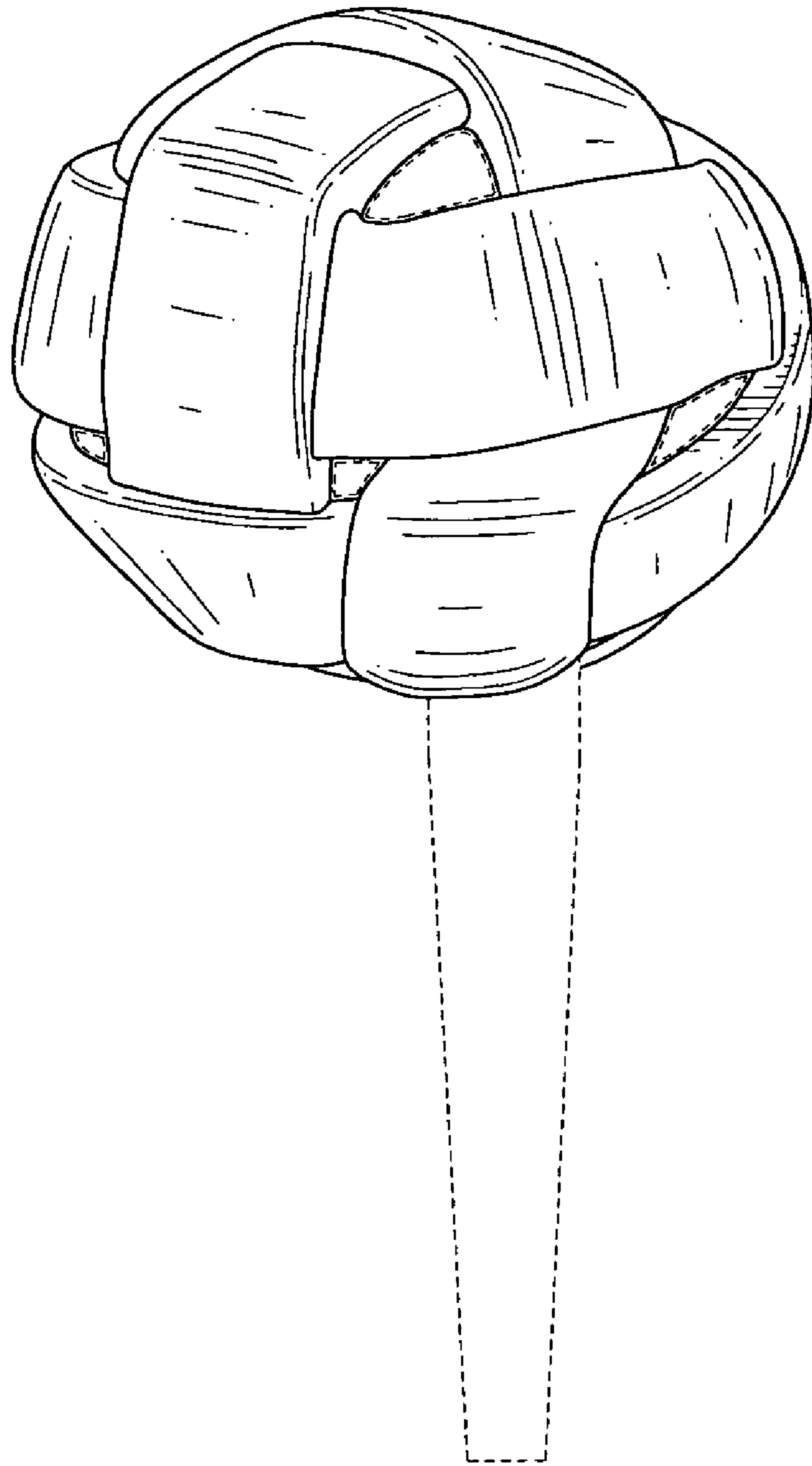

FIG. 4

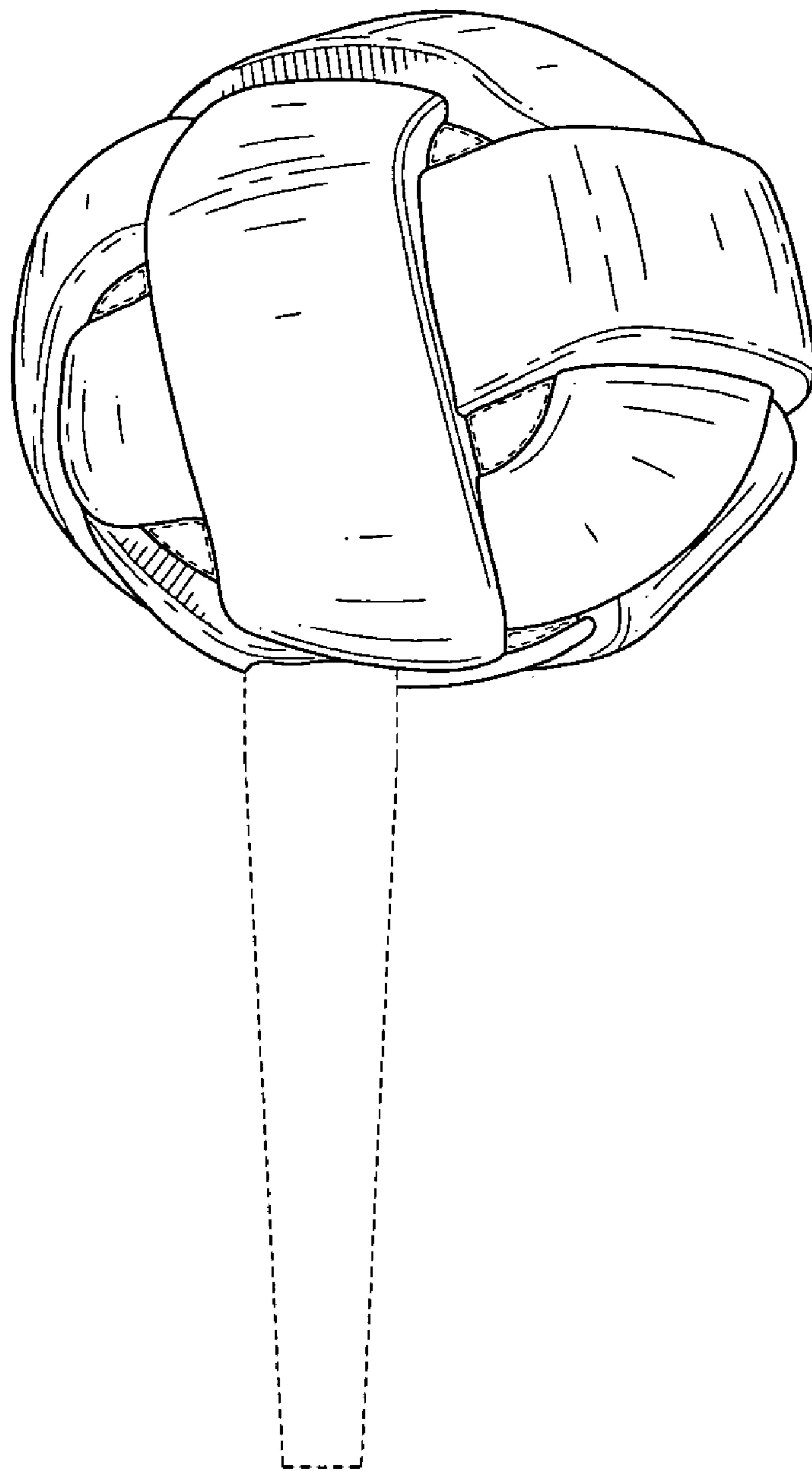

FIG. 5

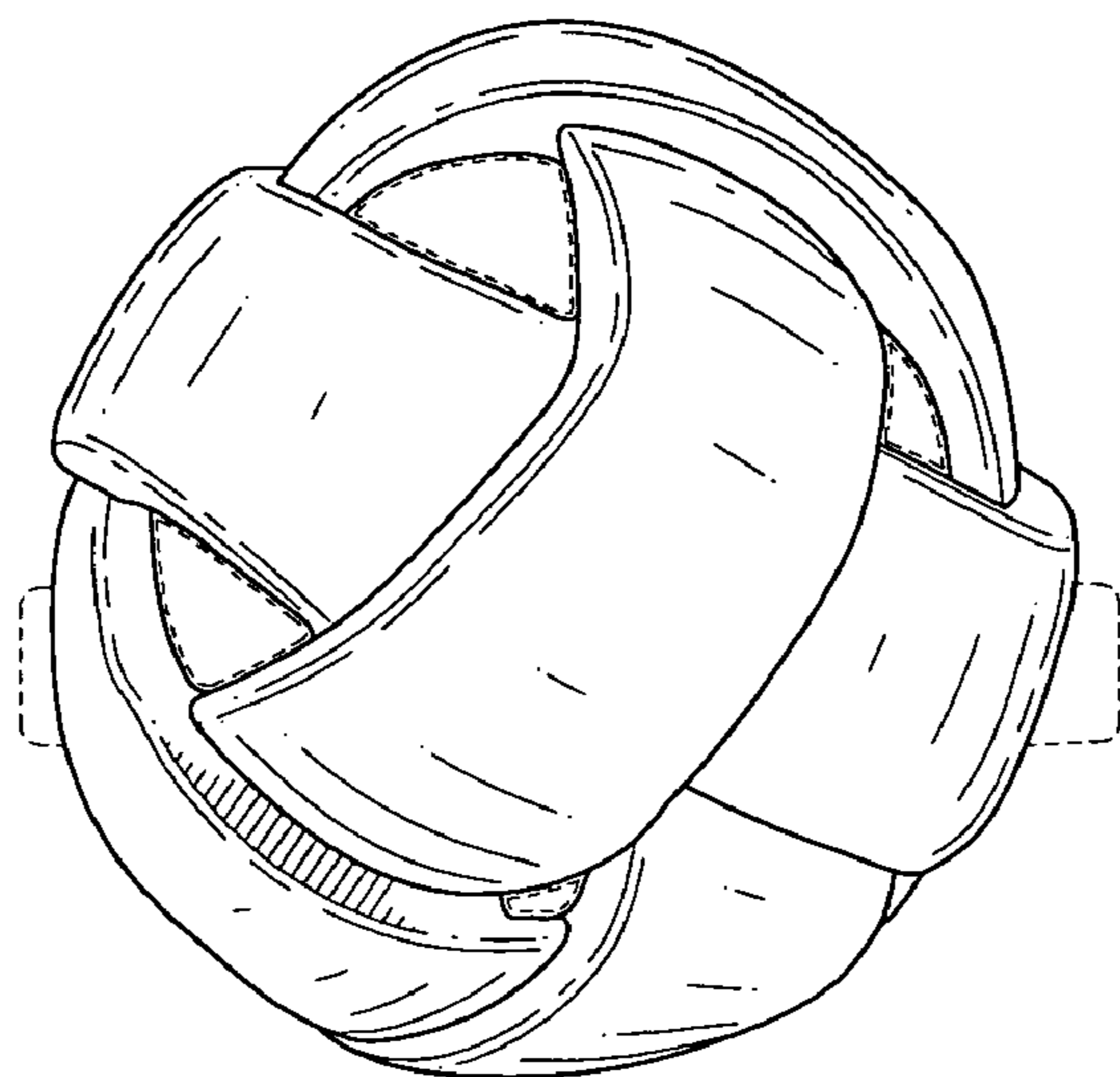

FIG. 6

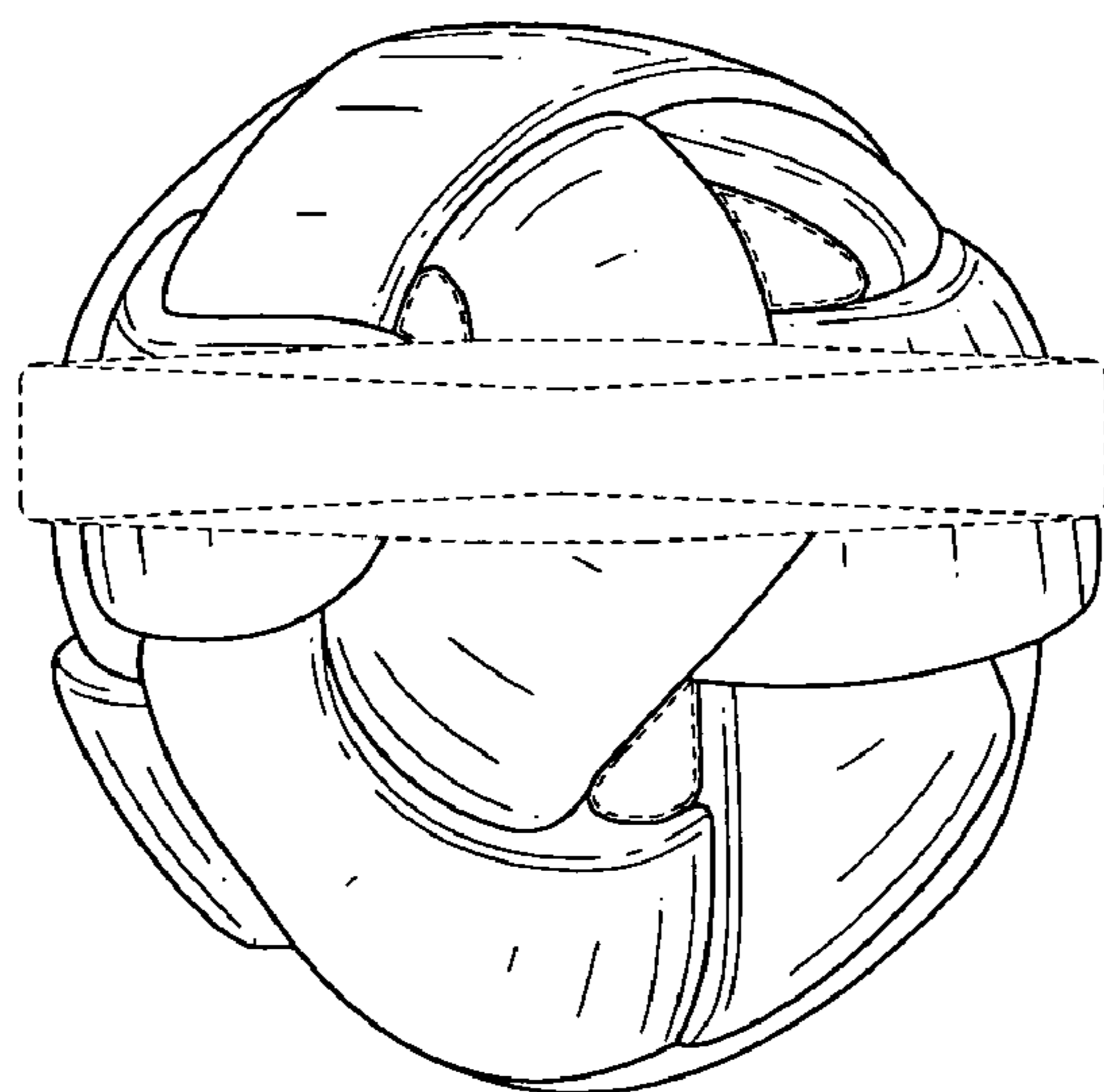

FIG. 7

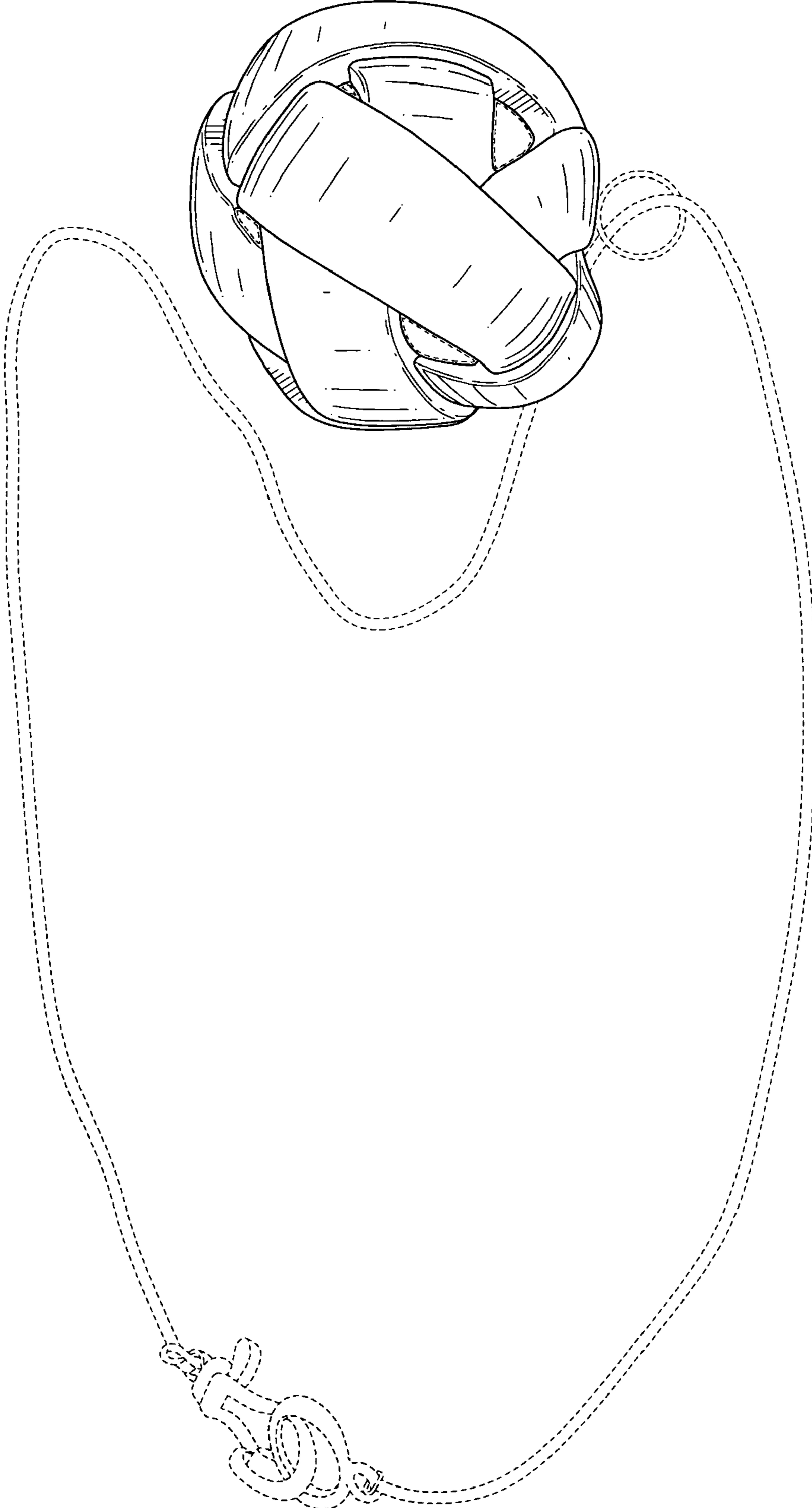

FIG. 8