

US00D663559S

(12) **United States Design Patent**
Hassman

(10) **Patent No.:** **US D663,559 S**
(45) **Date of Patent:** **** Jul. 17, 2012**

(54) **FOOTBALL CHAIR**
(75) Inventor: **Ellen Hassman**, Hollywood, FL (US)
(73) Assignee: **Consumer Motivation Group, Inc.**,
New York, NY (US)

5,690,379 A * 11/1997 Cayssials 297/181
D496,802 S * 10/2004 Hightower D6/358
D503,554 S * 4/2005 Kay D6/358
D536,888 S * 2/2007 Dykstra D6/358
D620,268 S * 7/2010 Van Halder D6/358

* cited by examiner

(**) Term: **14 Years**

Primary Examiner — Mimosa De

(74) *Attorney, Agent, or Firm* — Robert M. Downey, P.A.

(21) Appl. No.: **29/388,768**

(22) Filed: **Apr. 1, 2011**

(51) **LOC (9) Cl.** **06-01**

(52) **U.S. Cl.** **D6/502; D26/358**

(58) **Field of Classification Search** D6/334-336,
D6/345, 351, 358, 361, 370, 374, 376, 379,
D6/380, 500-502; 297/118, 181, 377, 452.63;
D21/788, 825

See application file for complete search history.

(57) **CLAIM**

The ornamental design for a football chair, as shown and described.

DESCRIPTION

FIG. 1 is a front, top perspective view of a football chair showing my new design;
FIG. 2 is a front elevational view thereof;
FIG. 3 is a rear elevational view thereof;
FIG. 4 is a left side elevational view thereof, the ride side elevational view being identical thereto;
FIG. 5 is a top plan view thereof; and,
FIG. 6 is a bottom plan view thereof.

The broken lines in FIGS. 1-6 are for illustrative purposes only and form no part of the claimed design.

(56) **References Cited**

U.S. PATENT DOCUMENTS

D252,602 S * 8/1979 Cirrone D6/358
D272,260 S * 1/1984 Budde D21/825
D333,170 S * 2/1993 Patton D21/788
D379,875 S * 6/1997 Wied et al. D6/351
D382,413 S * 8/1997 Lundberg D6/361

1 Claim, 6 Drawing Sheets

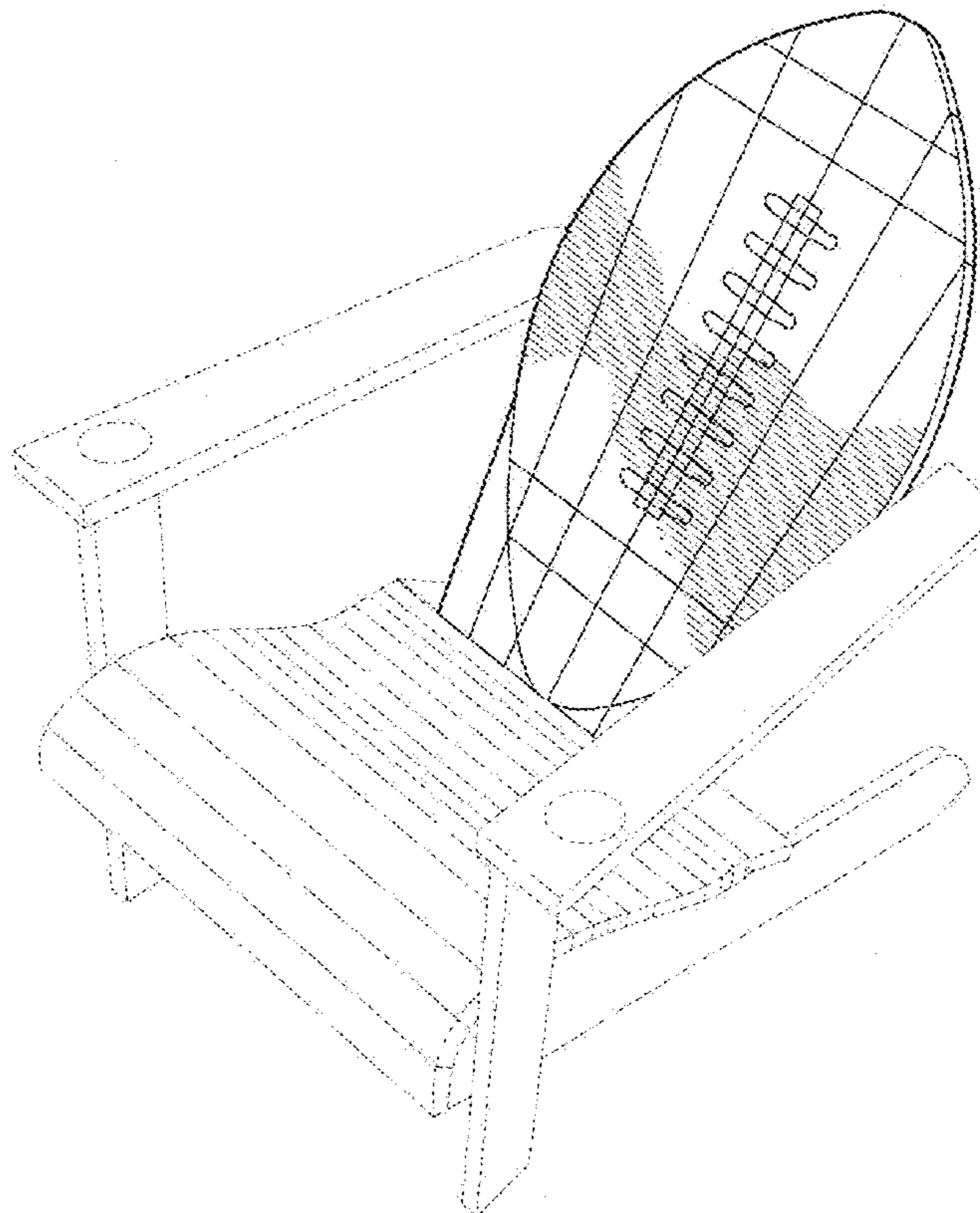

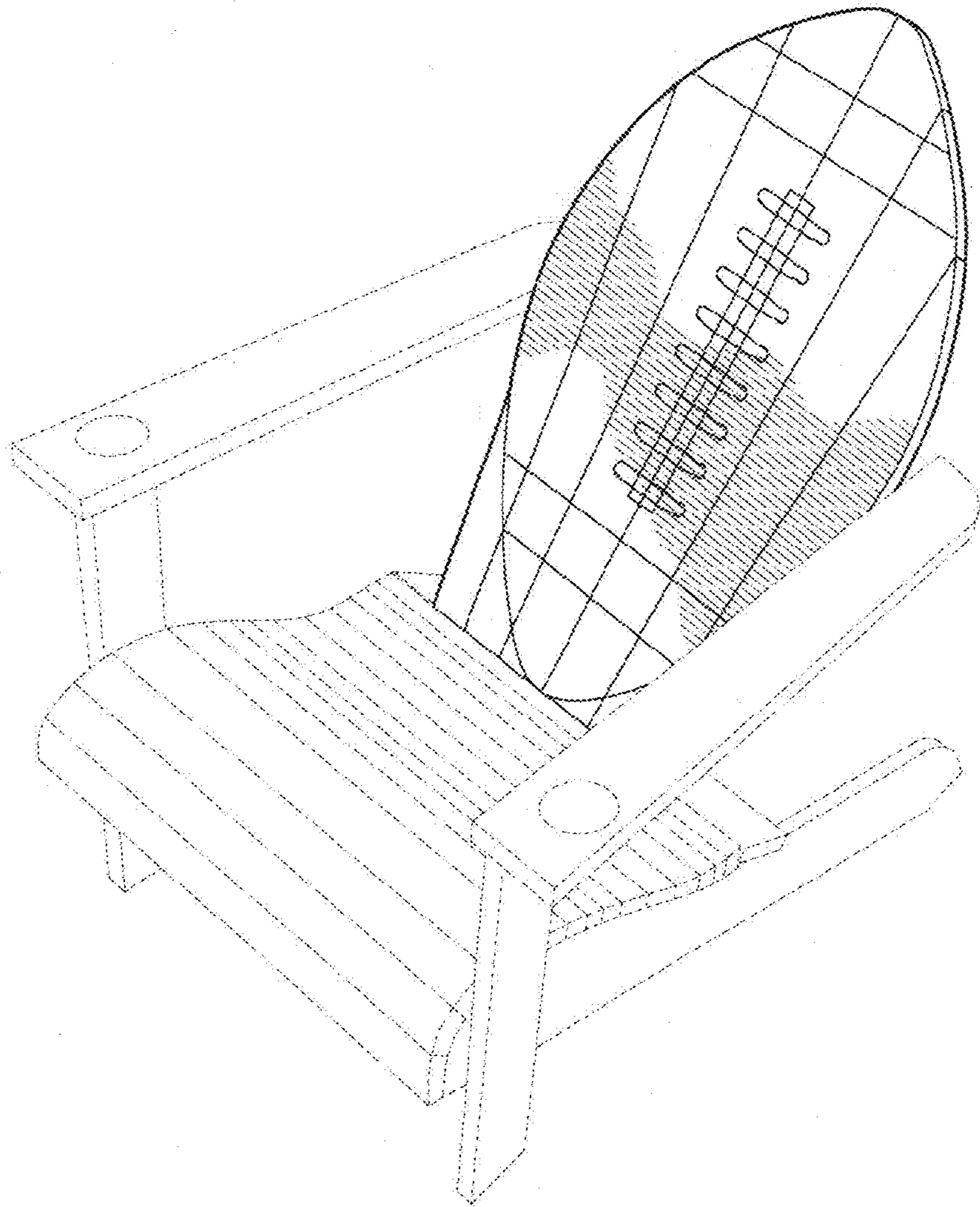

FIG. 1

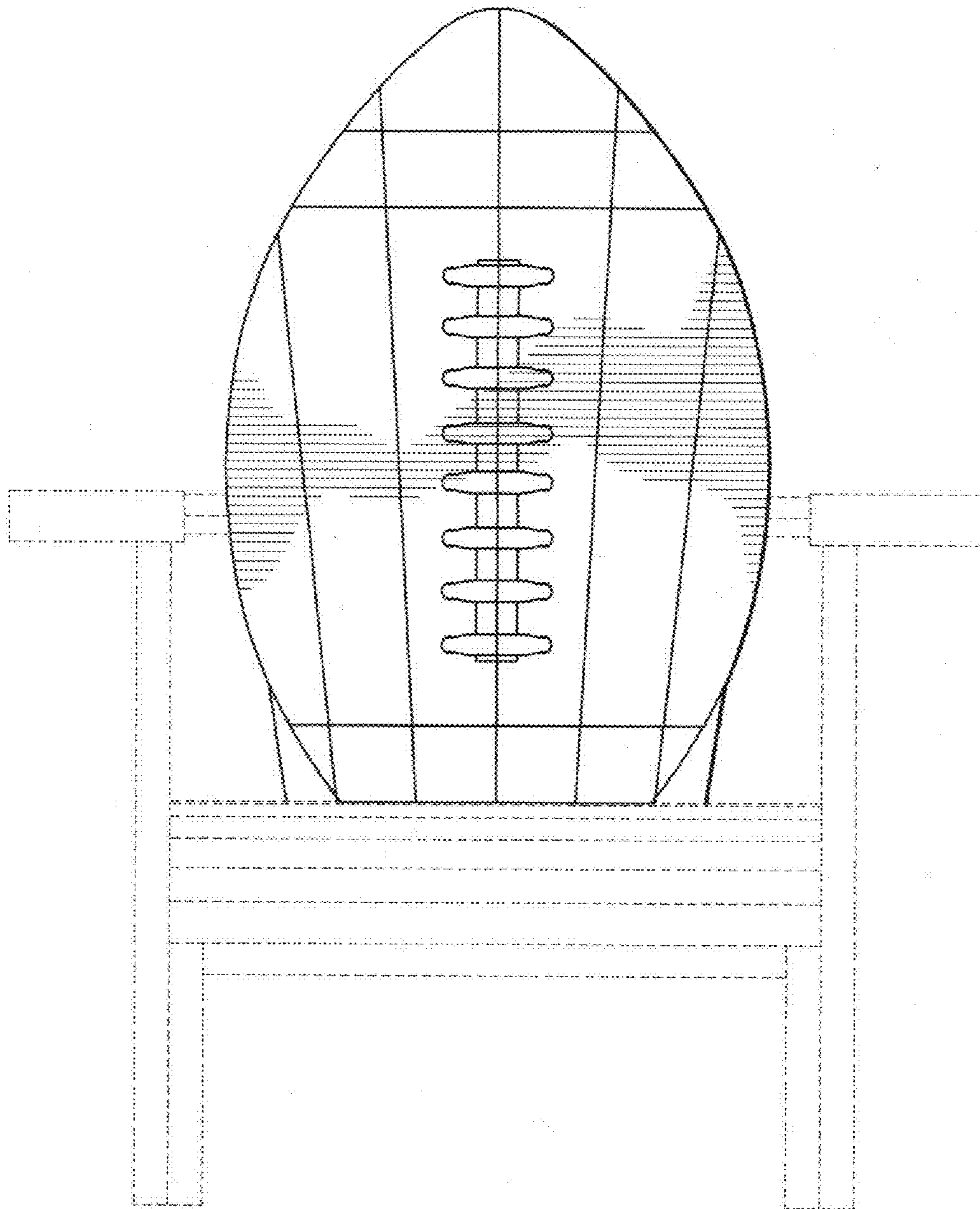

FIG. 2

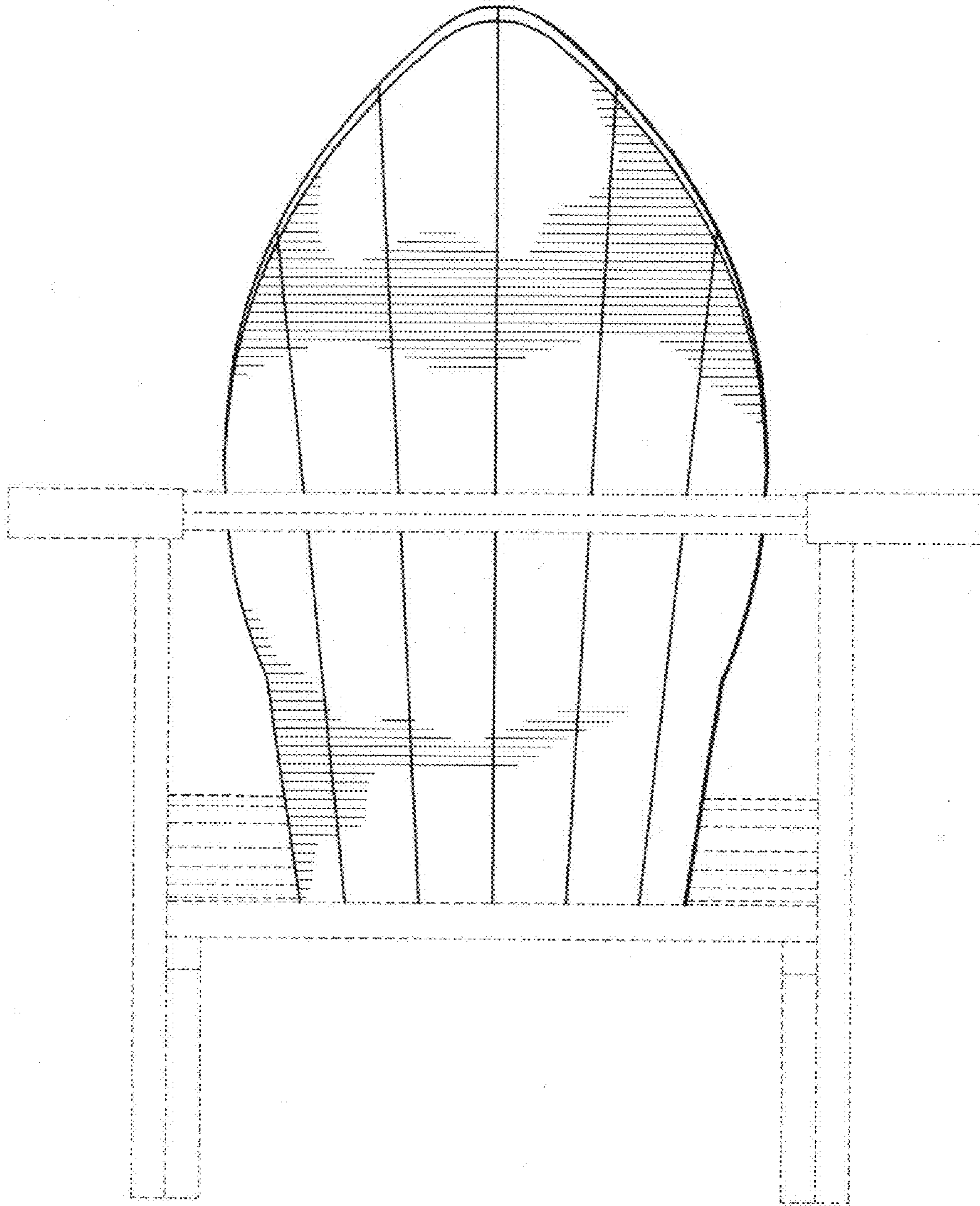

FIG. 3

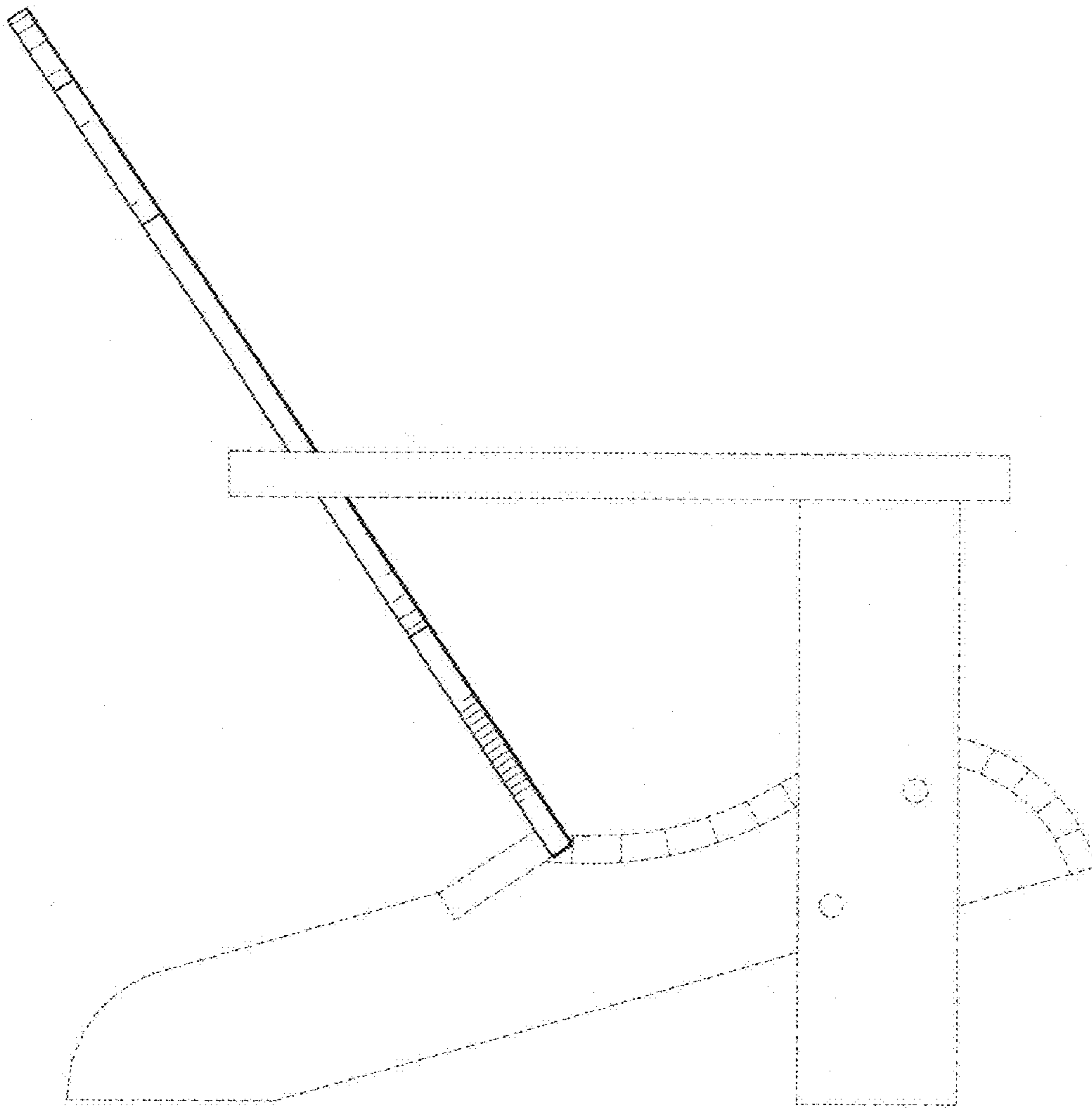

FIG. 4

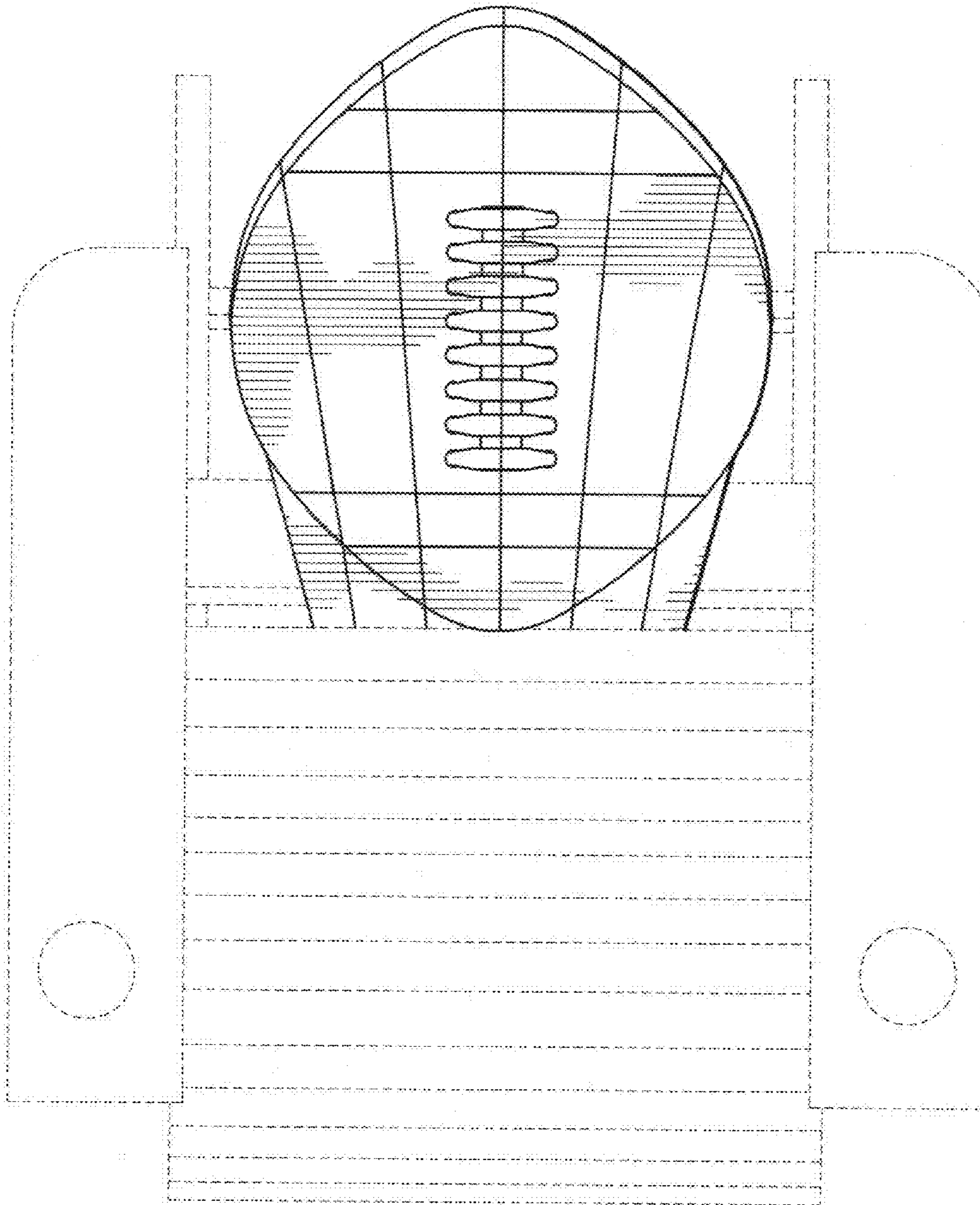

FIG. 5

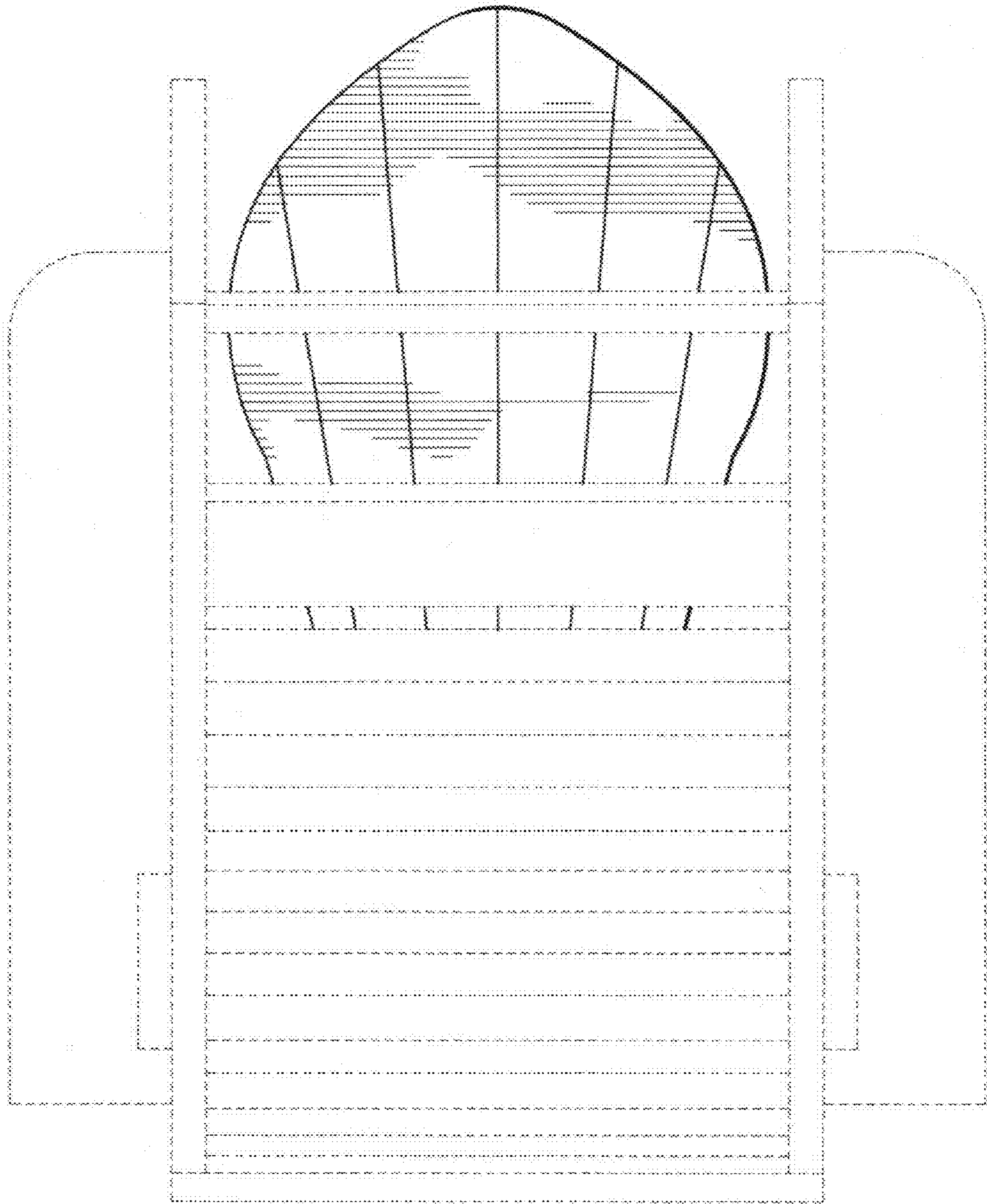

FIG. 6