



US00D663550S

(12) **United States Design Patent**
Fodor

(10) **Patent No.:** **US D663,550 S**
(45) **Date of Patent:** **** Jul. 17, 2012**

(54) **STORAGE CLOSET FOR HUNTING EQUIPMENT**

(76) Inventor: **Hunter G. Fodor**, Grass Lake, MI (US)

(**) Term: **14 Years**

(21) Appl. No.: **29/385,935**

(22) Filed: **Feb. 23, 2011**

(51) **LOC (9) Cl.** **06-04**

(52) **U.S. Cl.** **D6/446**

(58) **Field of Classification Search** D6/432,
D6/436, 437, 438, 439, 445, 446, 447, 448,
D6/477, 178, 479; 312/107, 109, 114, 119,
312/138.1, 204, 223.3, 237, 249.4, 249.11,
312/249.12, 249.13, 257.1

See application file for complete search history.

(56) **References Cited**

U.S. PATENT DOCUMENTS

969,900	A	9/1910	Paxton	
1,251,947	A	1/1918	Wheary	
1,566,956	A	12/1925	Duff et al.	
1,568,814	A	1/1926	Duff et al.	
1,673,730	A	6/1928	Bartels	
1,772,304	A	8/1930	Bosque	
4,371,221	A	2/1983	Citterio	
4,669,790	A *	6/1987	Briggs	312/223.3
D363,618	S *	10/1995	Cramer	D6/446
5,533,799	A *	7/1996	Nickolaus, Jr.	312/249.12
D376,496	S *	12/1996	Kelley et al.	D6/446
5,664,853	A *	9/1997	Nickolaus, Jr.	312/249.12
D397,262	S *	8/1998	Thomas	D6/446
D411,392	S *	6/1999	Welborn, Jr.	D6/445
5,931,553	A *	8/1999	Cohen	312/257.1
D417,976	S *	12/1999	Tisbo et al.	D6/446
D445,597	S *	7/2001	Stone et al.	D6/446

D467,756	S *	12/2002	Mattick	D6/446
D527,927	S *	9/2006	Nowotarski et al.	D6/446
D532,626	S *	11/2006	McDiarmid et al.	D6/446
D532,627	S *	11/2006	Nowotarski et al.	D6/446
D593,772	S *	6/2009	Knight	D6/436
D594,249	S *	6/2009	Newton	D6/446
D609,936	S *	2/2010	Haimoff	D6/432
D611,268	S *	3/2010	Knight	D6/436

* cited by examiner

Primary Examiner — Mimoso De

(74) *Attorney, Agent, or Firm* — Montgomery Patent & Design, LLC; Robert C. Montgomery; Joseph T. Yaksich

(57) **CLAIM**

The ornamental design for a storage closet for hunting equipment, as shown and described.

DESCRIPTION

FIG. 1 is a front perspective view of a storage closet for hunting equipment, depicted in an open state, showing my new design;

FIG. 2 is a front view thereof;

FIG. 3 is a rear view thereof;

FIG. 4 is a left side view thereof;

FIG. 5 is a right side view thereof;

FIG. 6 is a top view thereof;

FIG. 7 is a bottom view thereof;

FIG. 8 is a front perspective view of the storage closet for hunting equipment, depicted in a closed state;

FIG. 9 is a front view thereof;

FIG. 10 is a rear view thereof;

FIG. 11 is a left side view thereof with a right side being a mirror image; and,

FIG. 12 is a top view thereof with a bottom view being a mirror image.

1 Claim, 10 Drawing Sheets

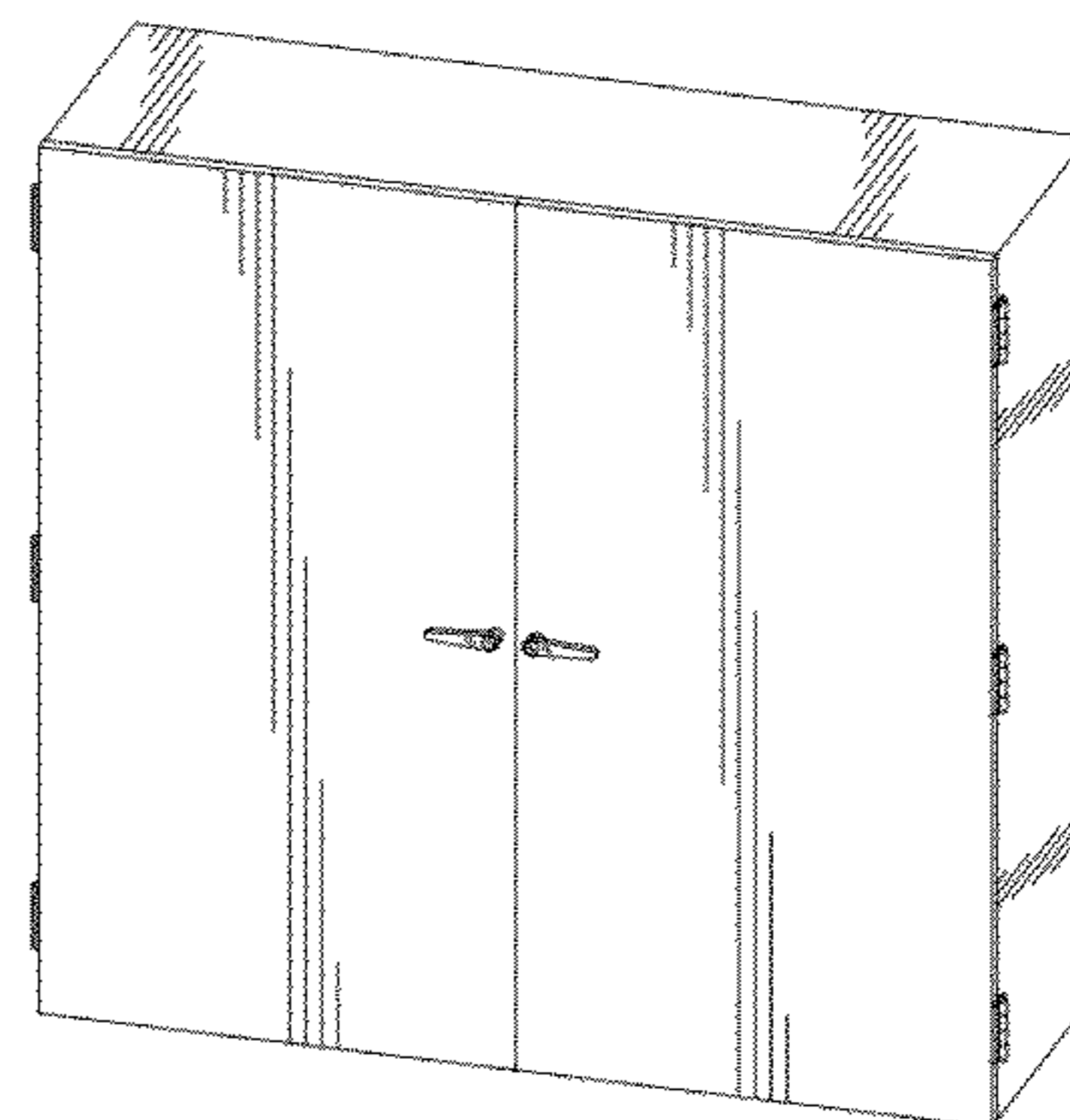
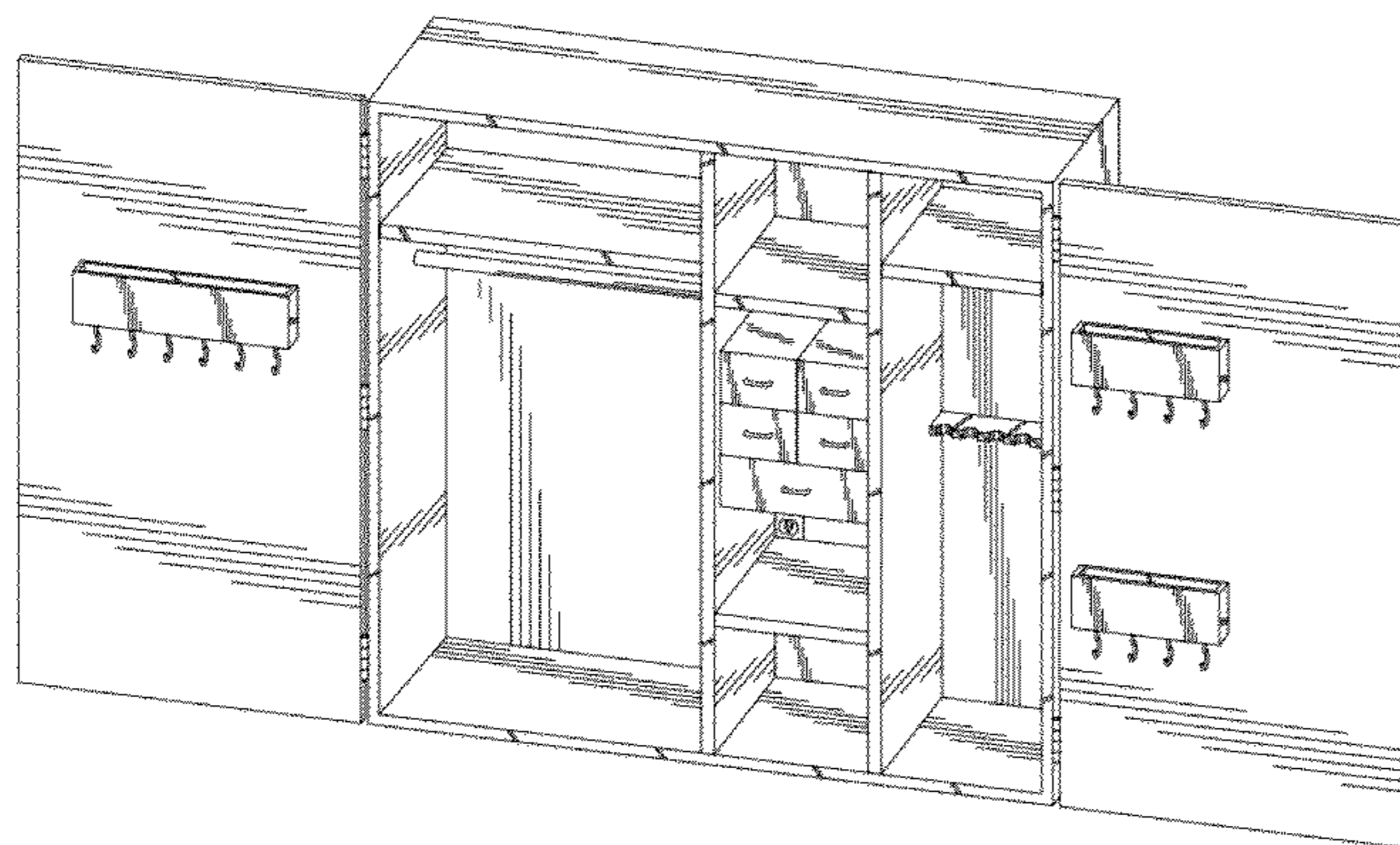

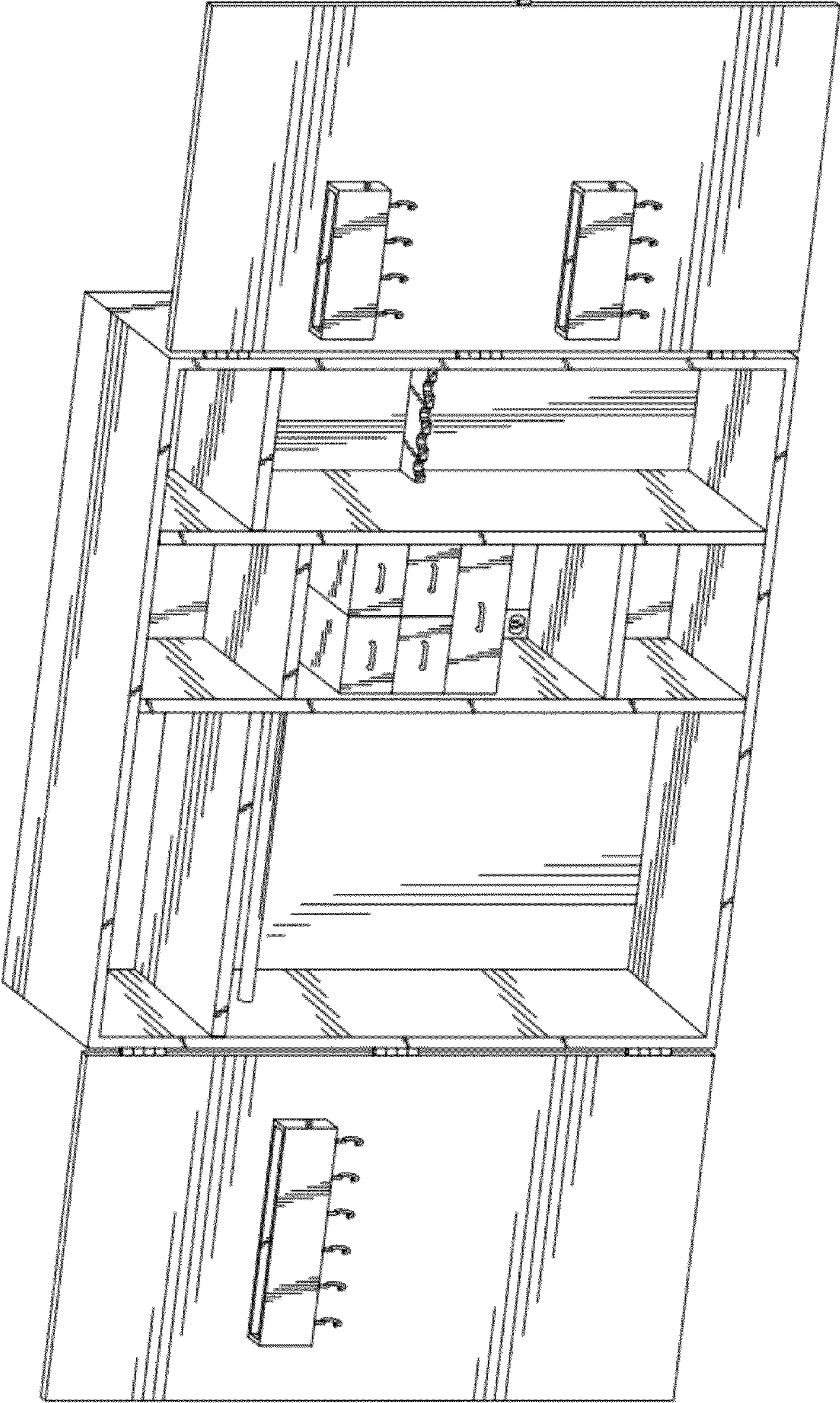

Fig. 1

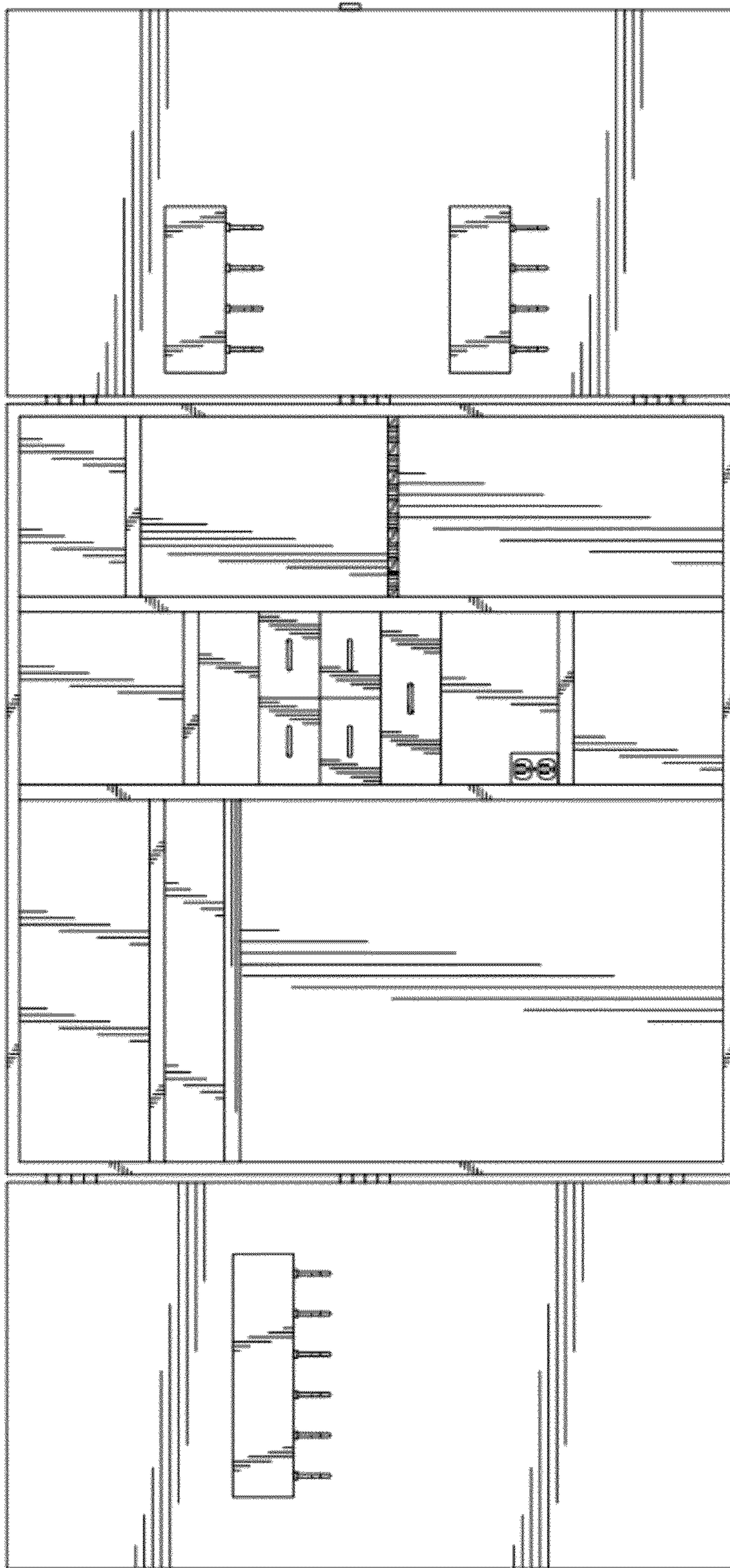

Fig. 2

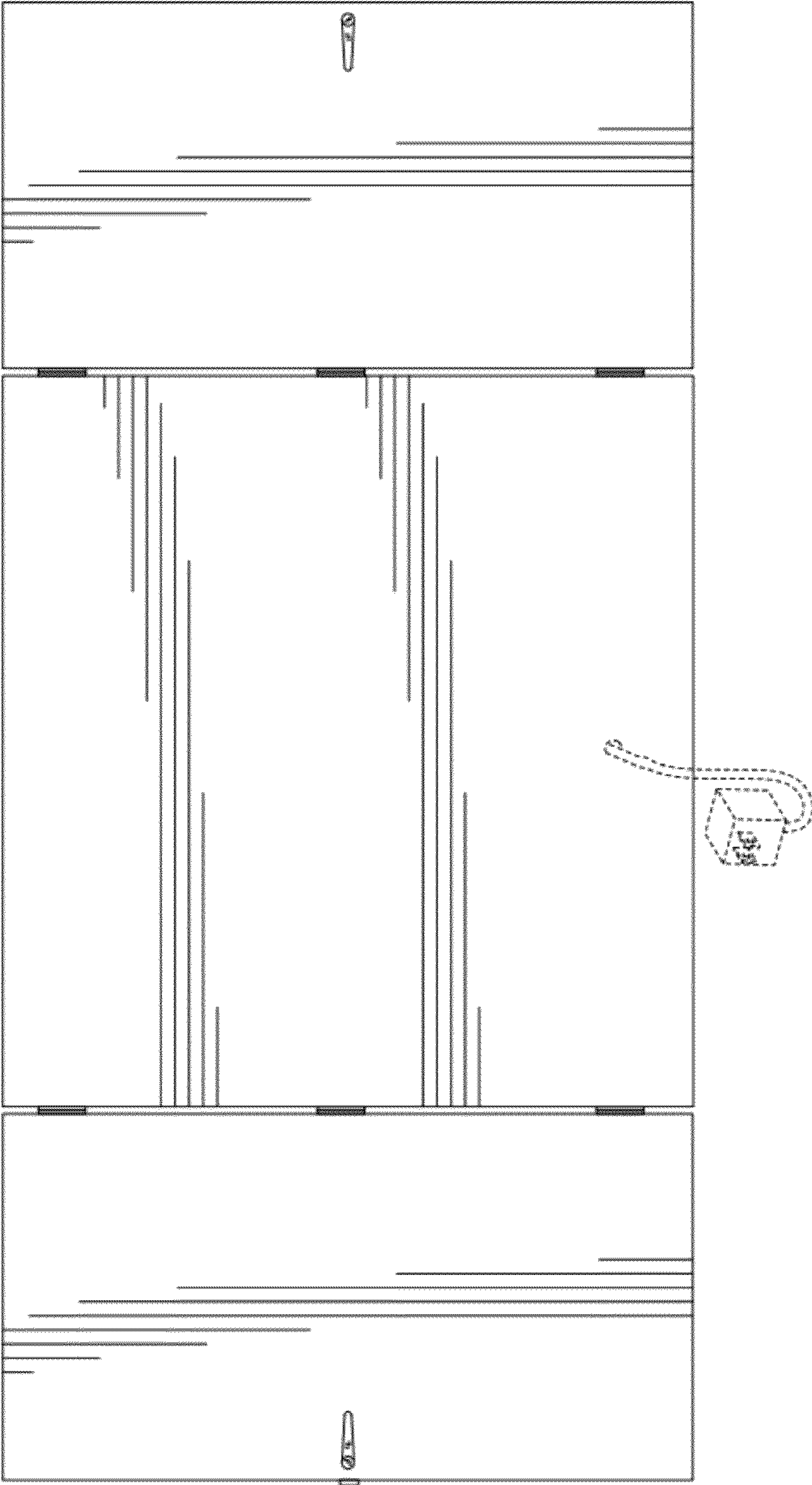

Fig. 3

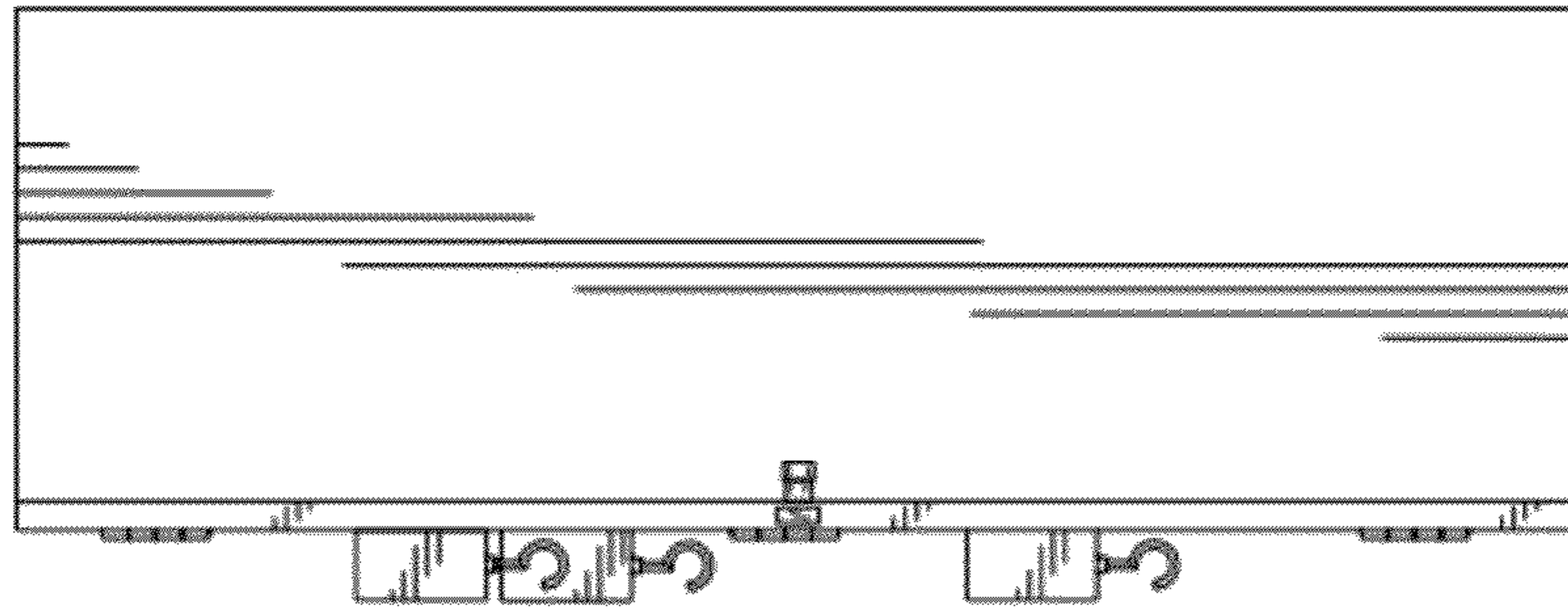

Fig. 5

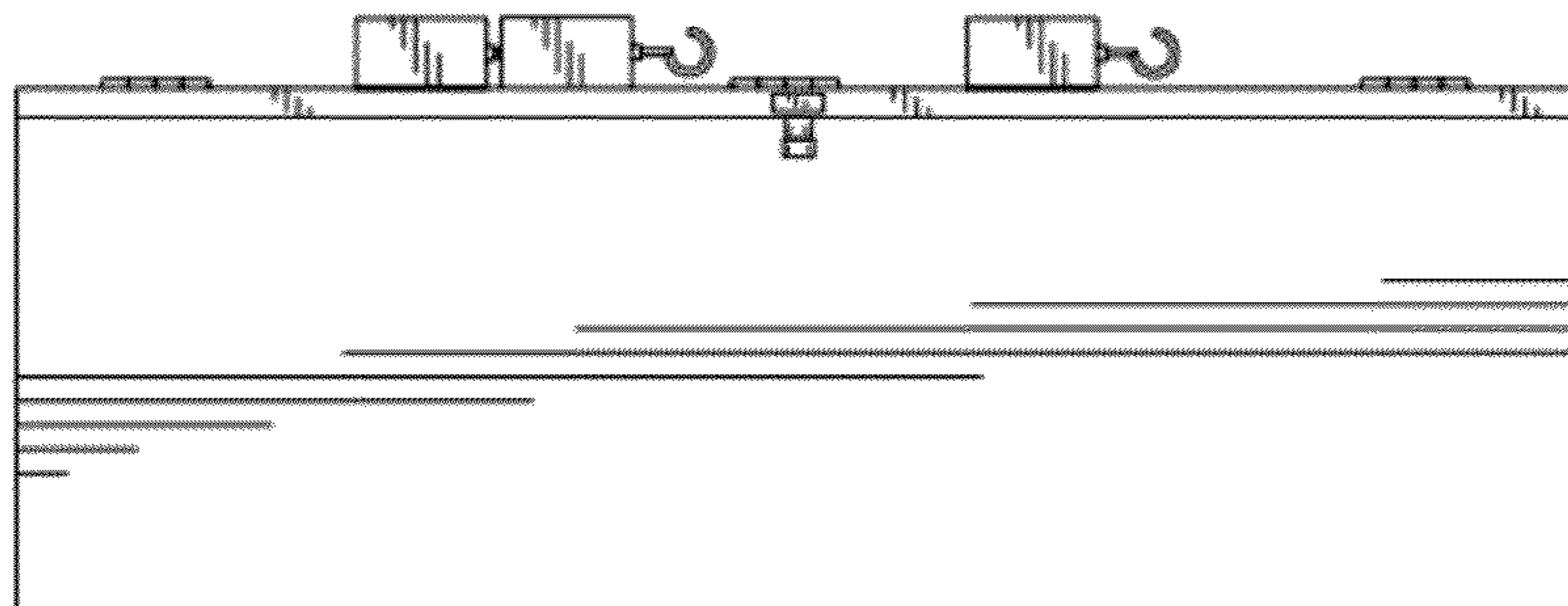

Fig. 4

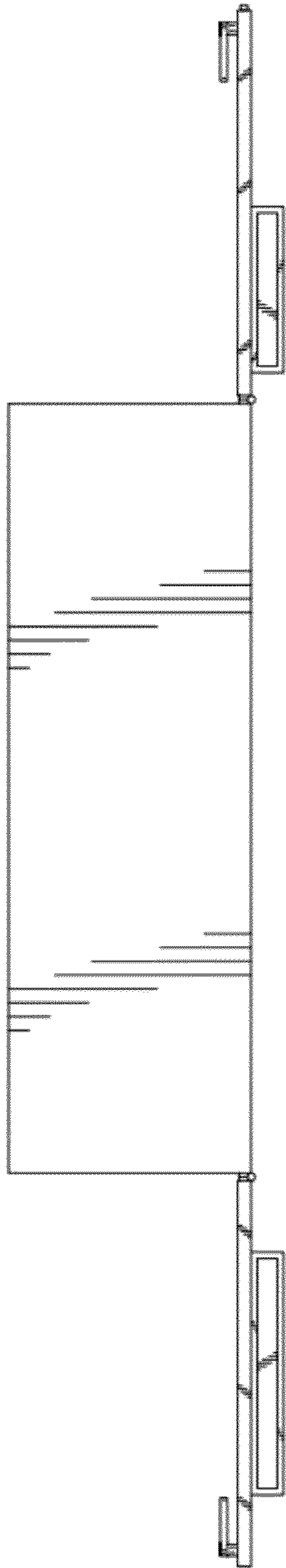

Fig. 6

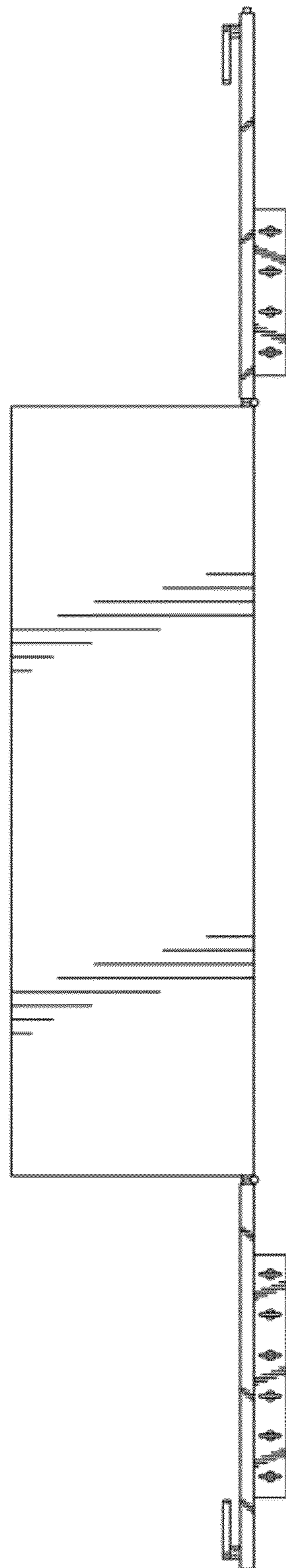

Fig. 7

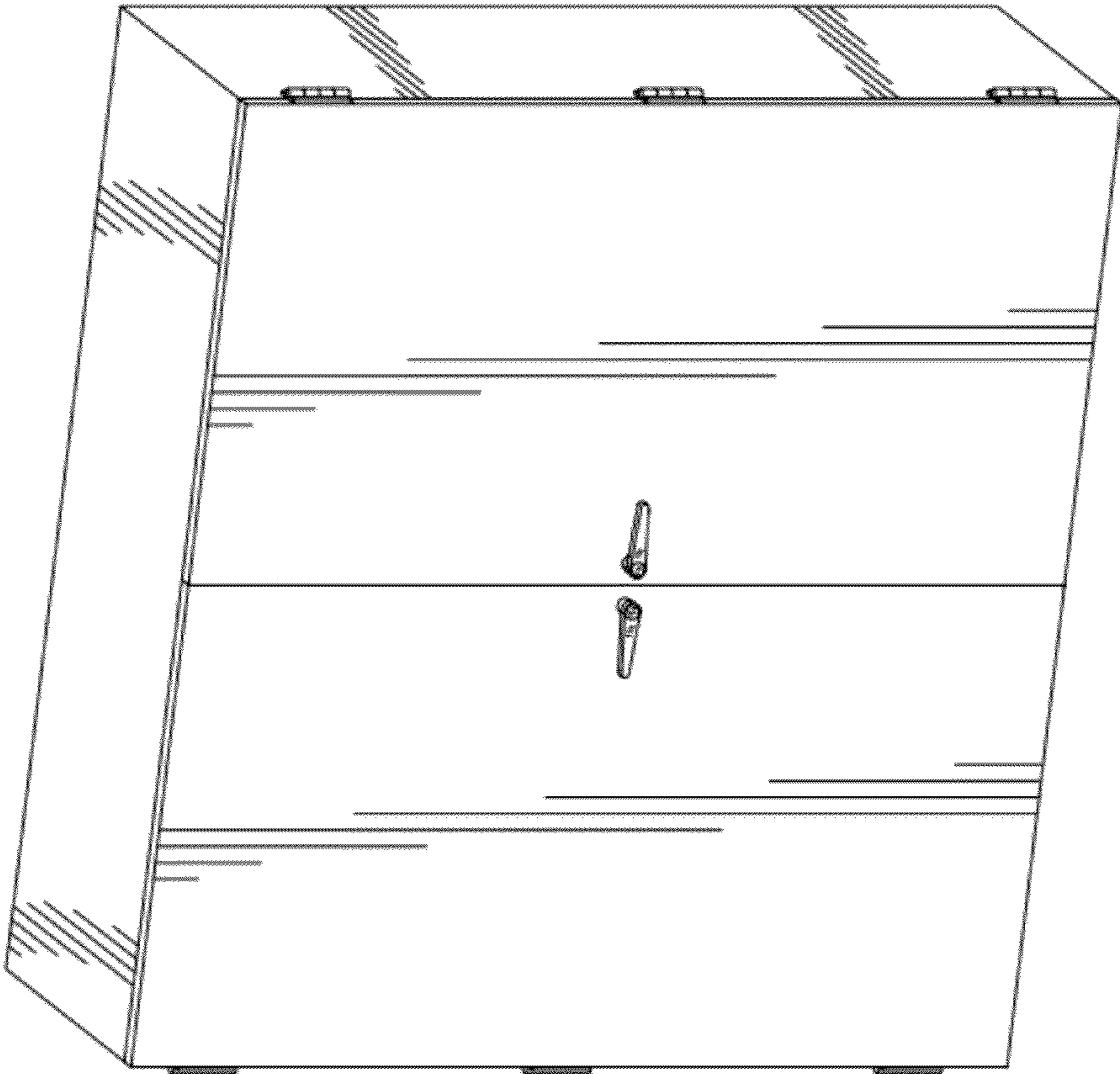

Fig. 8

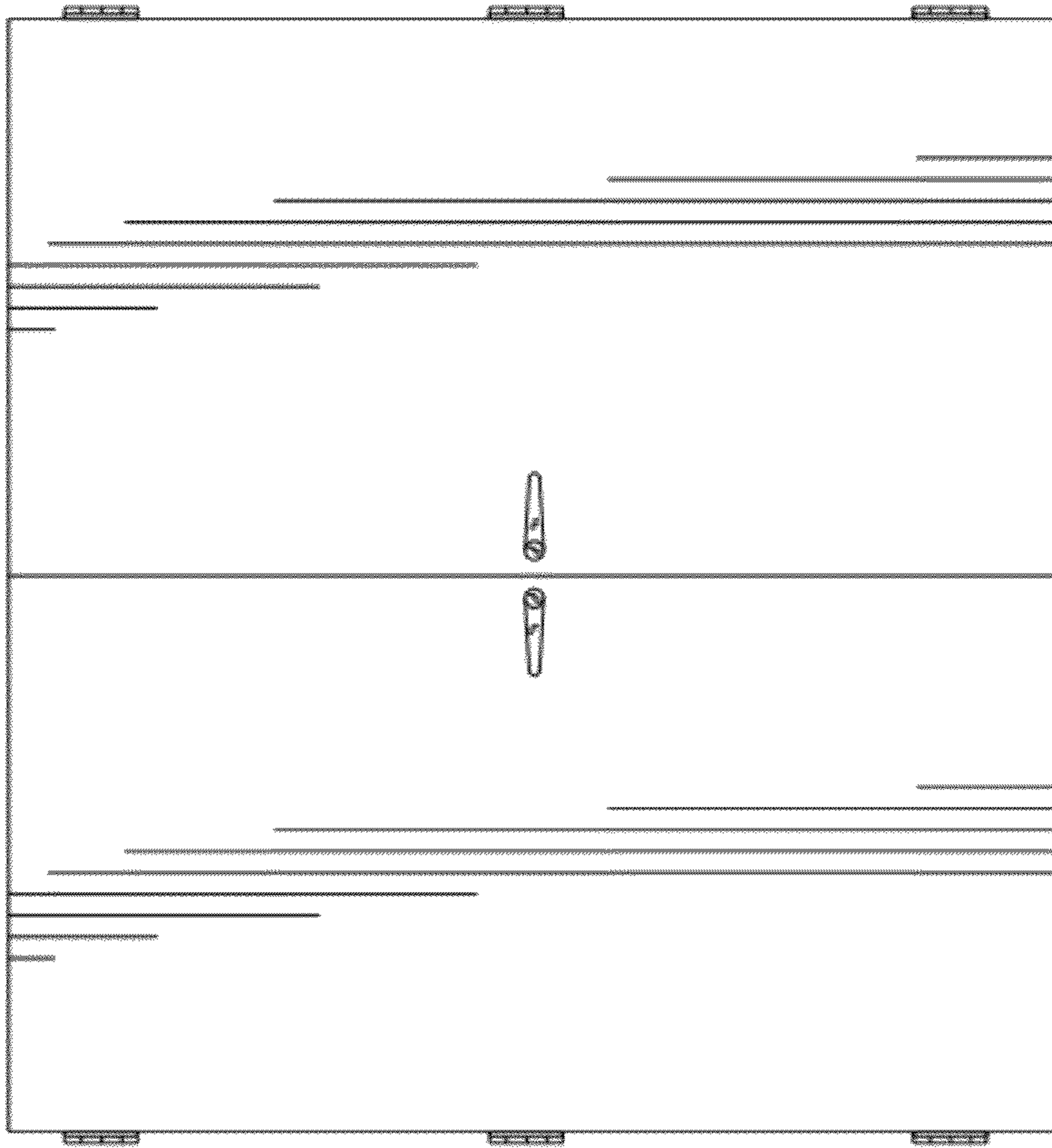

Fig. 9

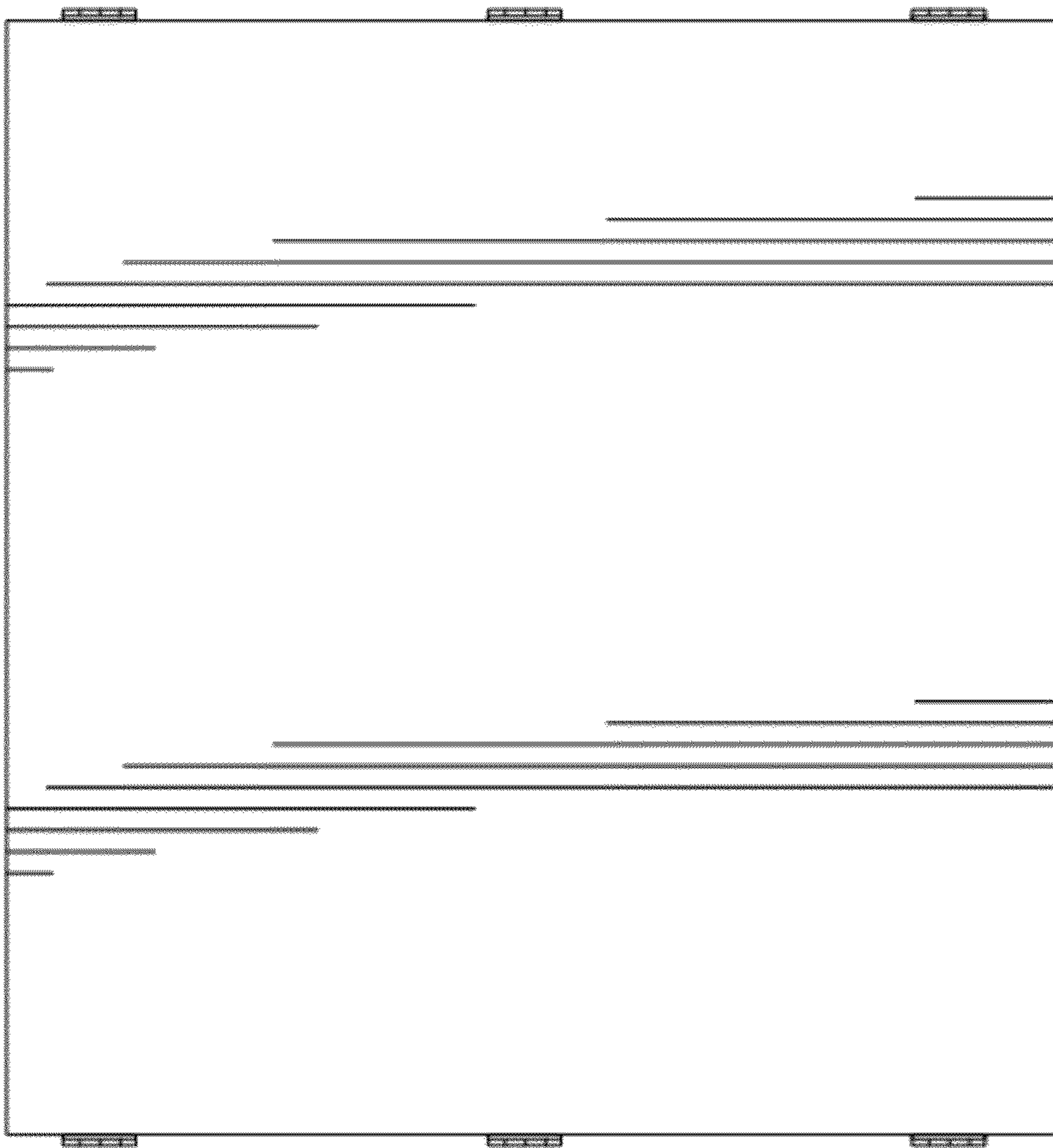

Fig. 10

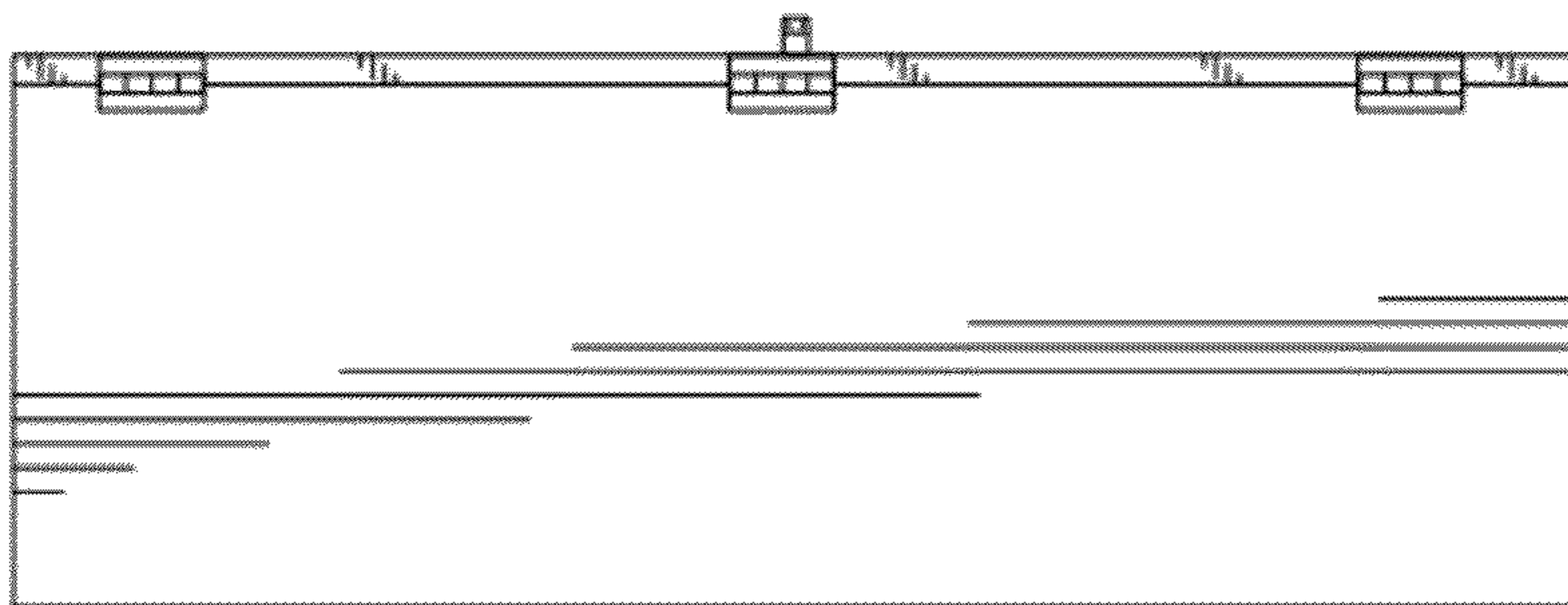

Fig. 11

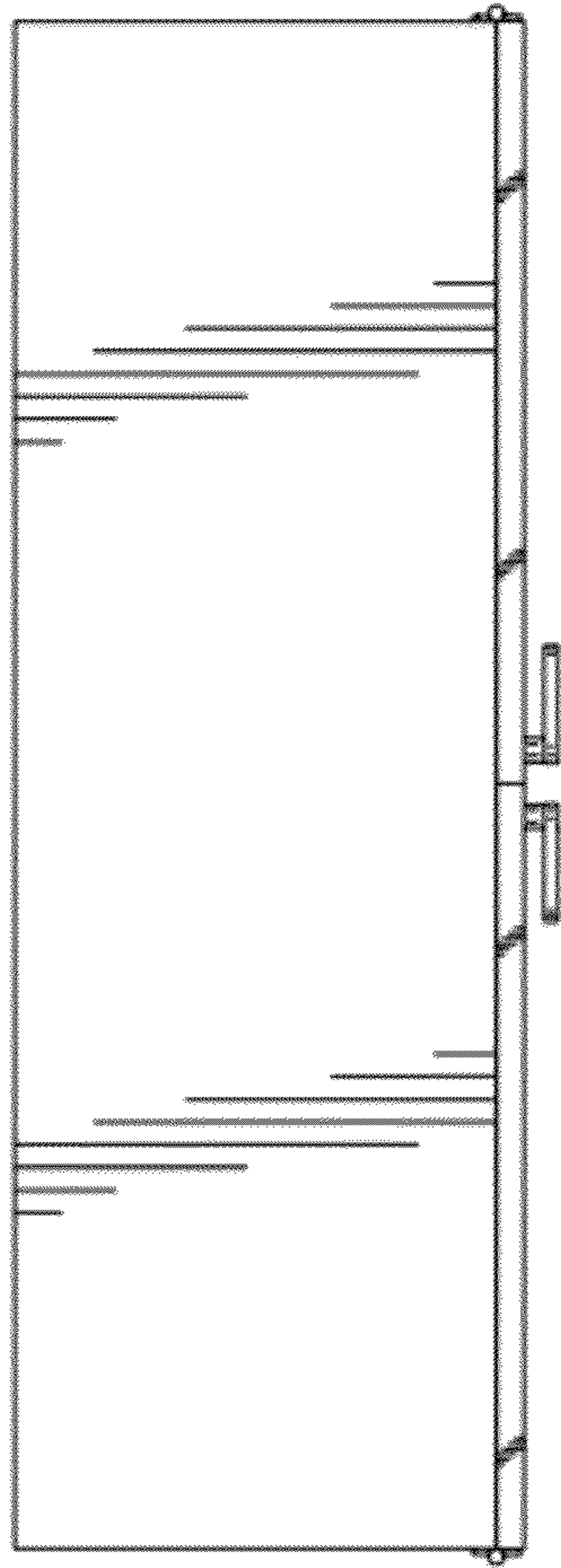

Fig. 12