



US00D663497S

(12) **United States Design Patent**
Ha et al.

(10) **Patent No.:** **US D663,497 S**
(45) **Date of Patent:** **** Jul. 10, 2012**

(54) **LAUNDRY DETERGENT HOLDER**

(75) Inventors: **Young Soo Ha**, Seoul (KR); **Myung Shik Kim**, Seoul (KR)

(73) Assignee: **LG Electronics Inc.**, Seoul (KR)

(**) Term: **14 Years**

(21) Appl. No.: **29/361,660**

(22) Filed: **May 13, 2010**

(51) **LOC (9) Cl.** **15-05**

(52) **U.S. Cl.** **D32/29.1**

(58) **Field of Classification Search** D32/1,
D32/25; 134/93, 200; 68/17 R, 207; 222/231;
D6/544-545; D3/273

See application file for complete search history.

(56) **References Cited**

U.S. PATENT DOCUMENTS

D232,187 S *	7/1974	McCollom	D32/25
4,917,272 A *	4/1990	Ikeda	68/17 R
D344,166 S *	2/1994	Jones	D32/30
7,428,831 B2 *	9/2008	Cho et al.	68/17 R
7,481,082 B2 *	1/2009	Cho et al.	68/17 R
7,543,465 B2 *	6/2009	Kwon et al.	68/17 R
7,555,923 B2 *	7/2009	Kim et al.	68/17 R
7,654,119 B2 *	2/2010	Song	68/17 R

D624,255 S *	9/2010	Ha	D32/25
7,805,964 B2 *	10/2010	Park	68/17 R
2003/0172690 A1 *	9/2003	Kim et al.	68/17 R

* cited by examiner

Primary Examiner — T. Chase Nelson
Assistant Examiner — Kathleen M Sims

(74) *Attorney, Agent, or Firm* — Morgan, Lewis & Bockius LLP

(57) **CLAIM**

The ornamental design for a laundry detergent holder, as shown and described.

DESCRIPTION

FIG. 1 is a top, front, perspective view of a laundry detergent holder showing our new design; FIG. 2 is a front view thereof; FIG. 3 is a rear view thereof; FIG. 4 is a left side view thereof; FIG. 5 is a right side view thereof; FIG. 6 is a top view thereof; FIG. 7 is a bottom view thereof; and, FIG. 8 is a reference view thereof.

The broken lines showing details in FIGS. 7 and 8 are included for the purposes of defining the bounds of the claim and of showing environmental portions of the laundry detergent holder and form no part of the claimed design.

1 Claim, 5 Drawing Sheets

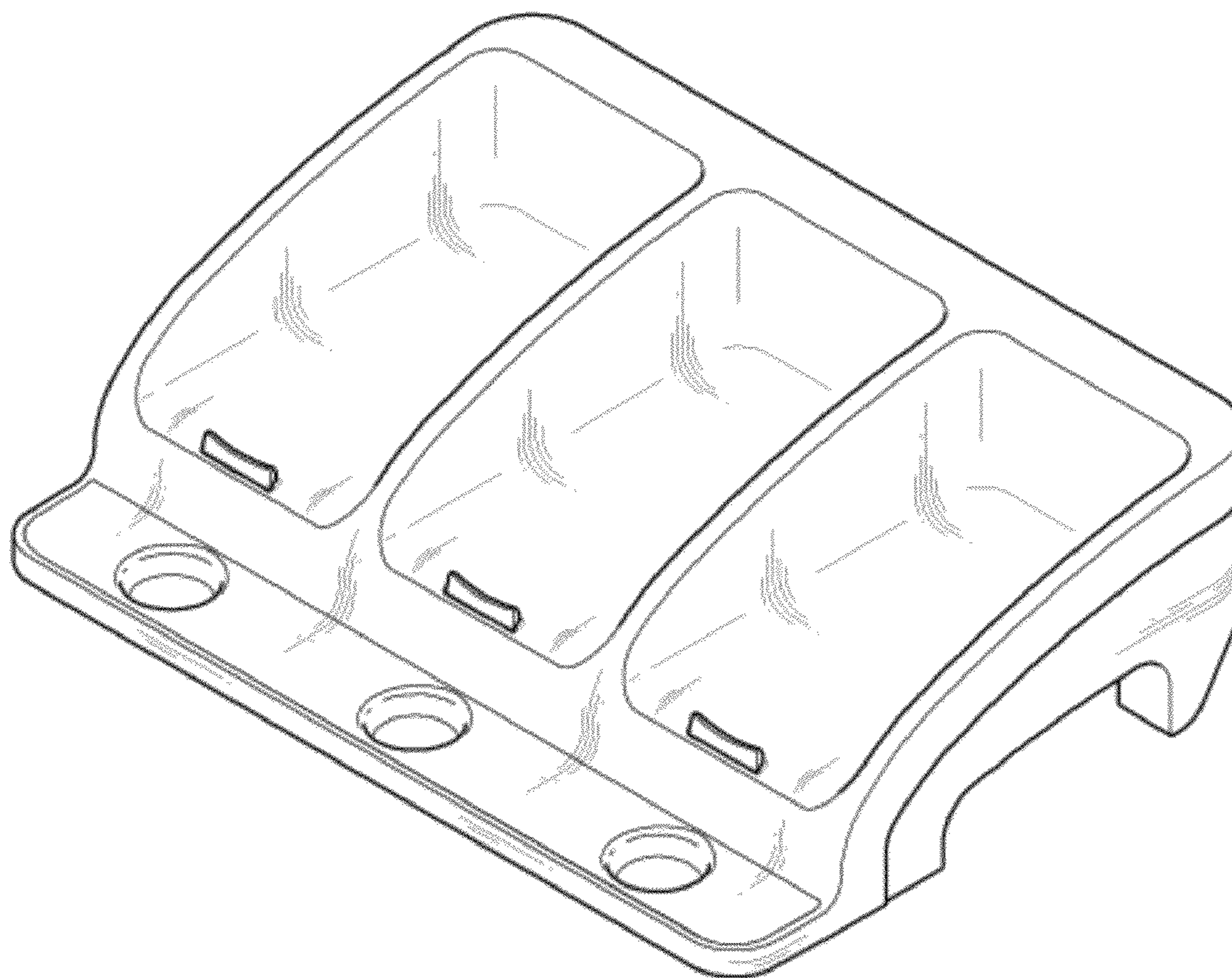

FIG. 1

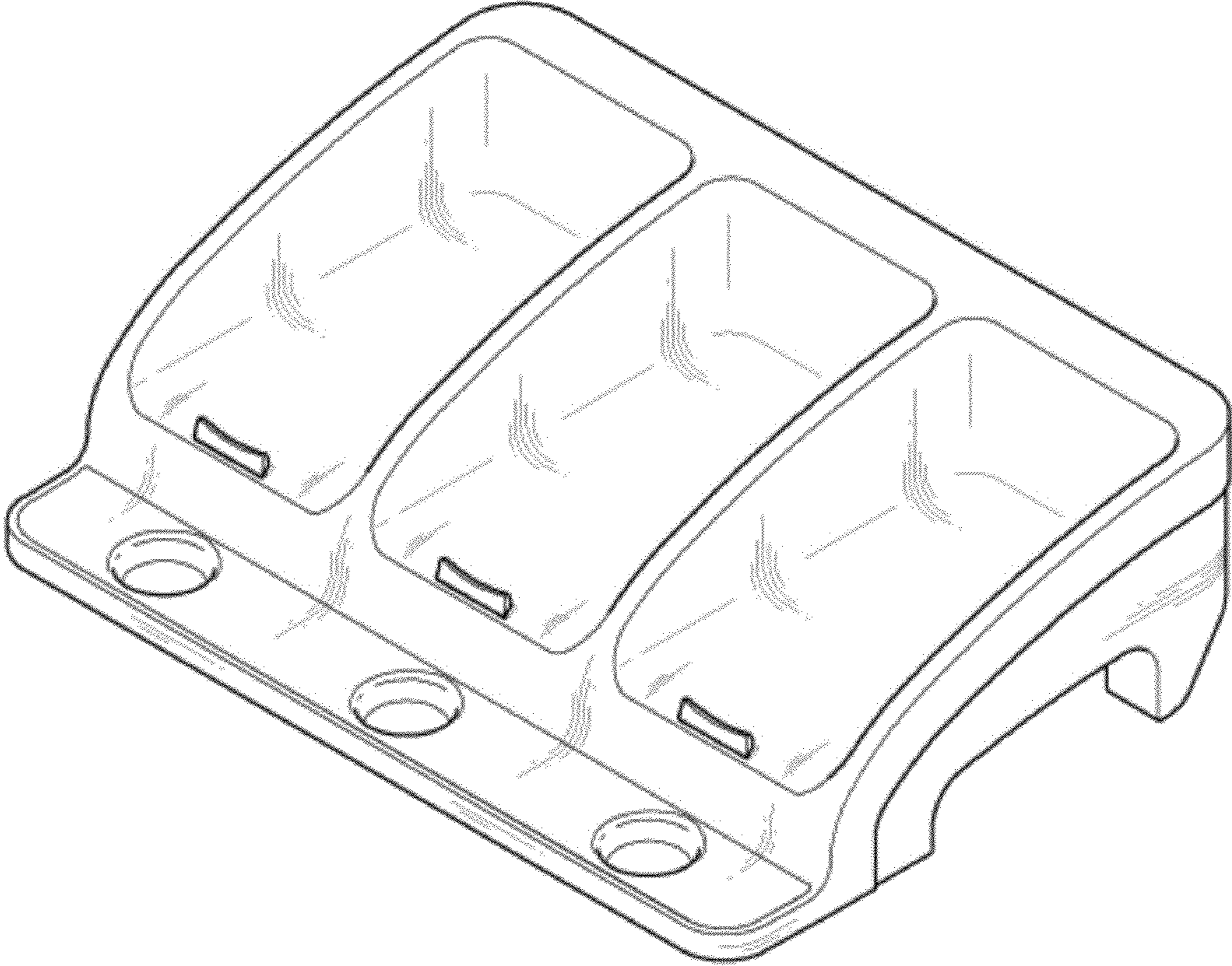

FIG. 2

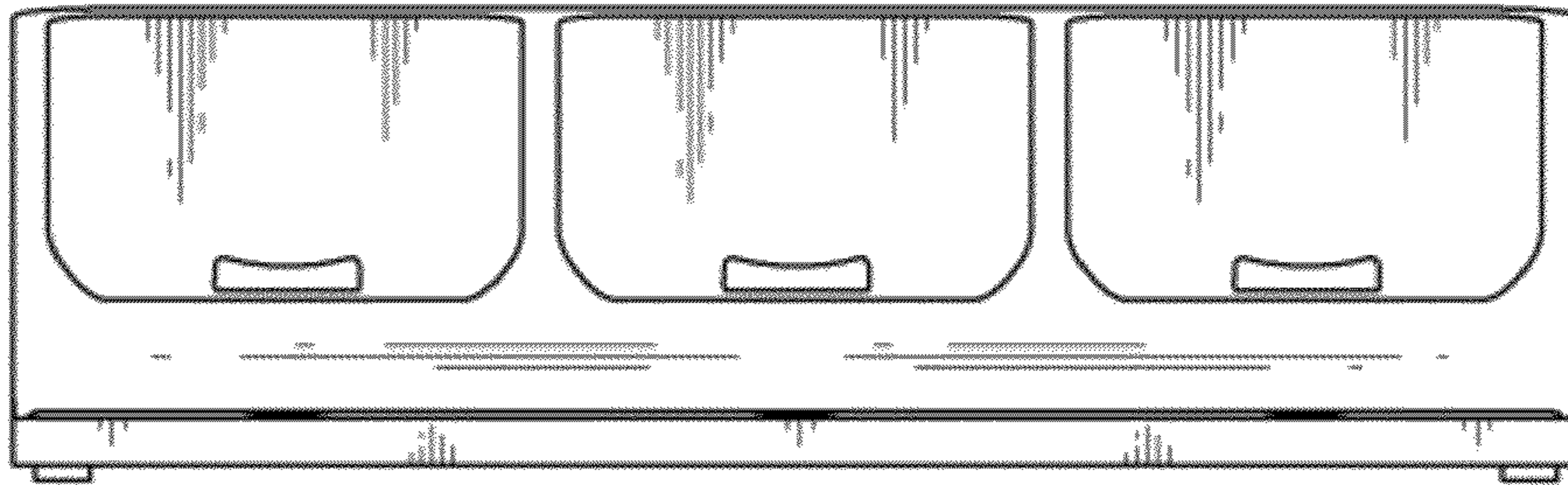

FIG. 3

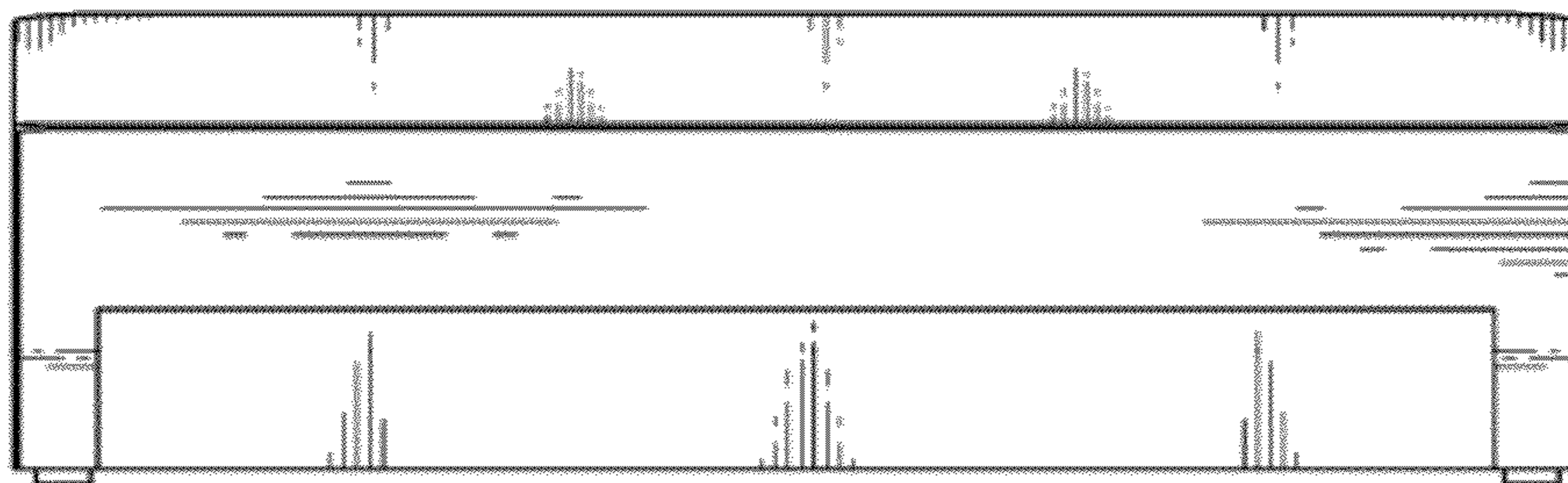

FIG. 4

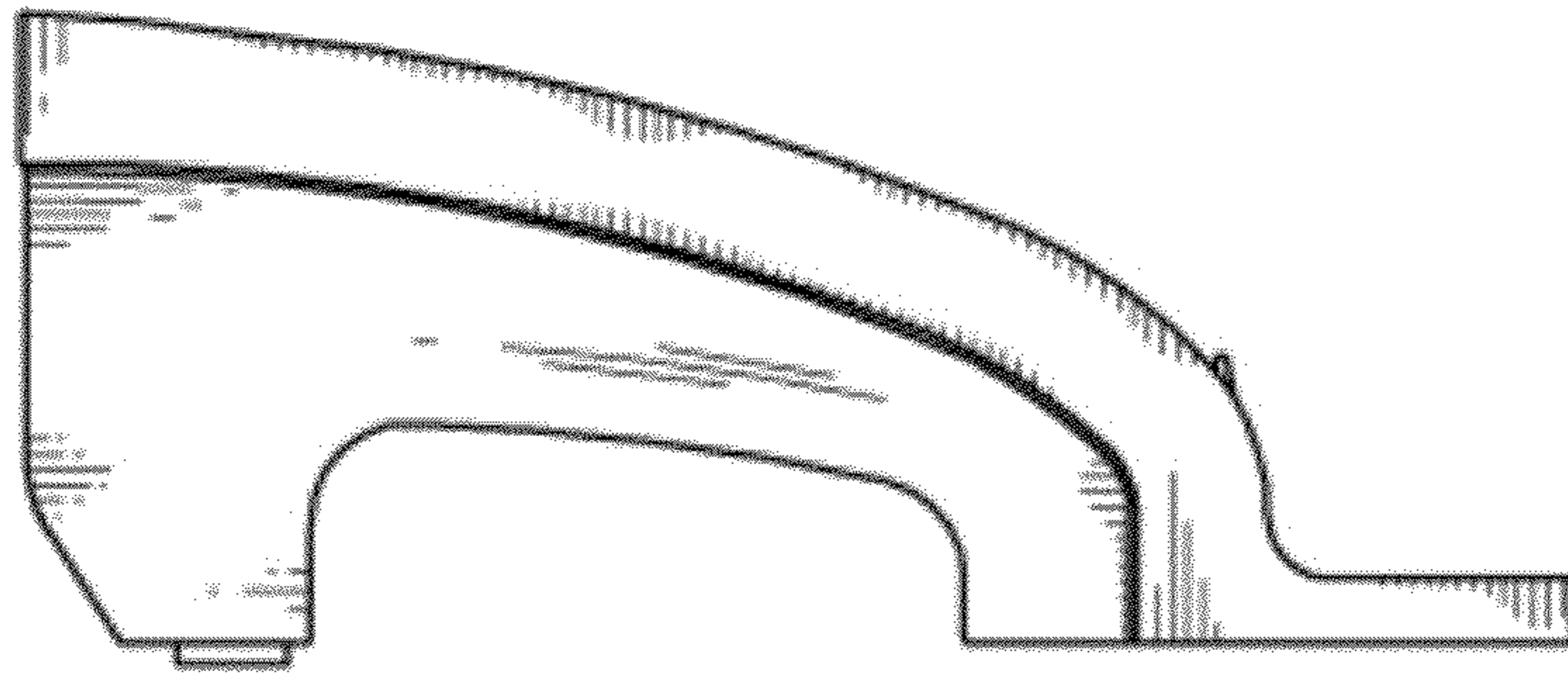

FIG. 5

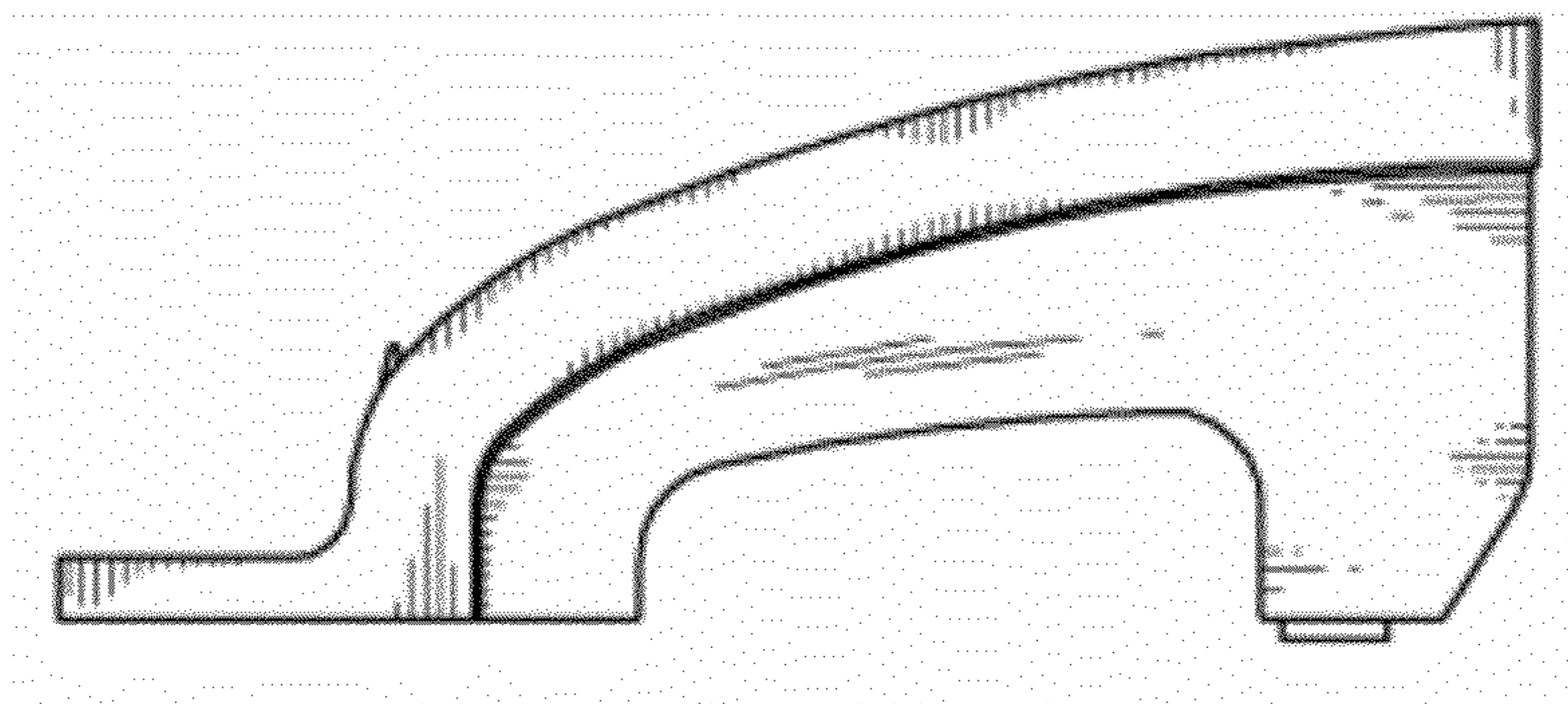

FIG. 6

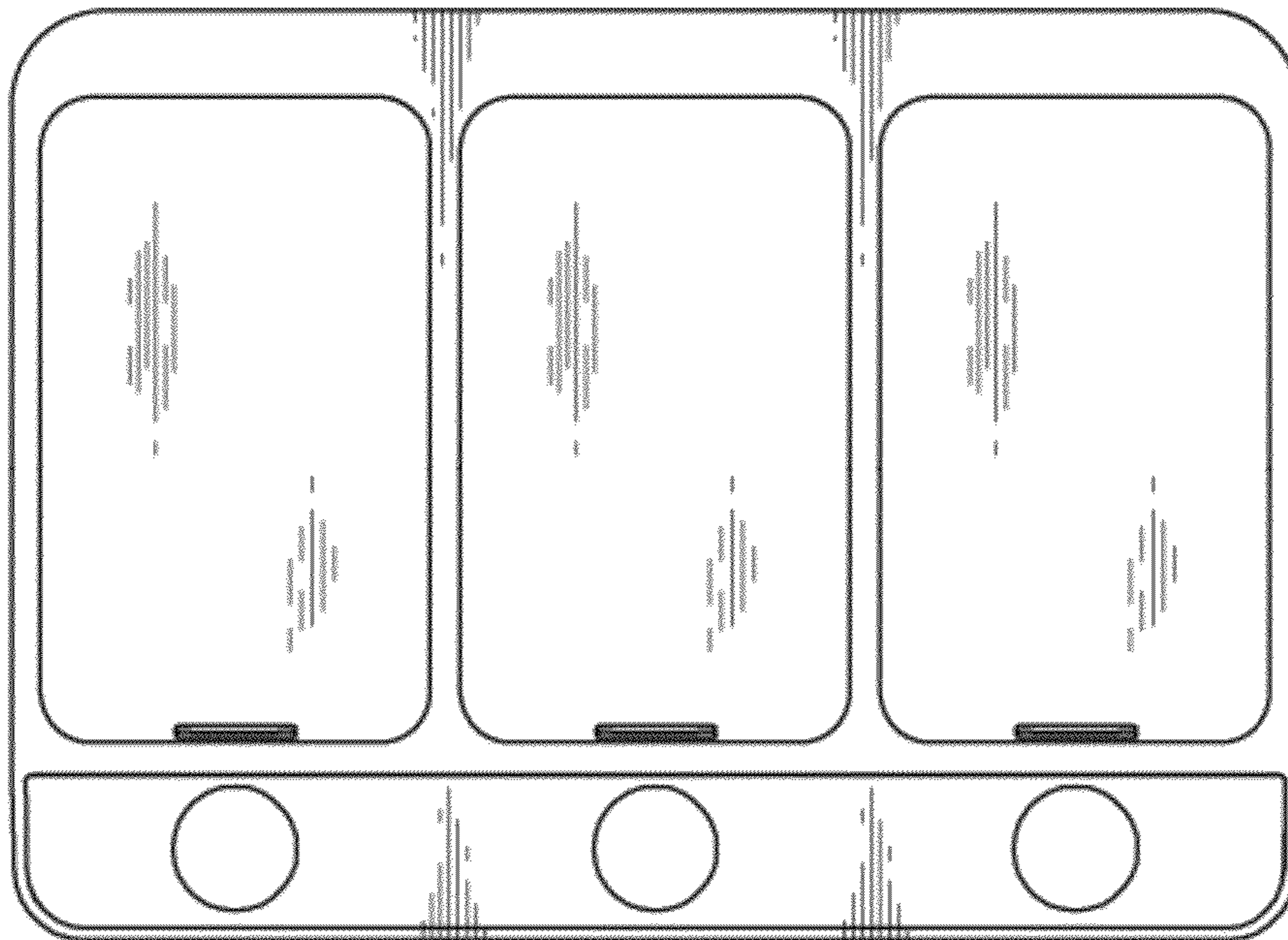

FIG. 7

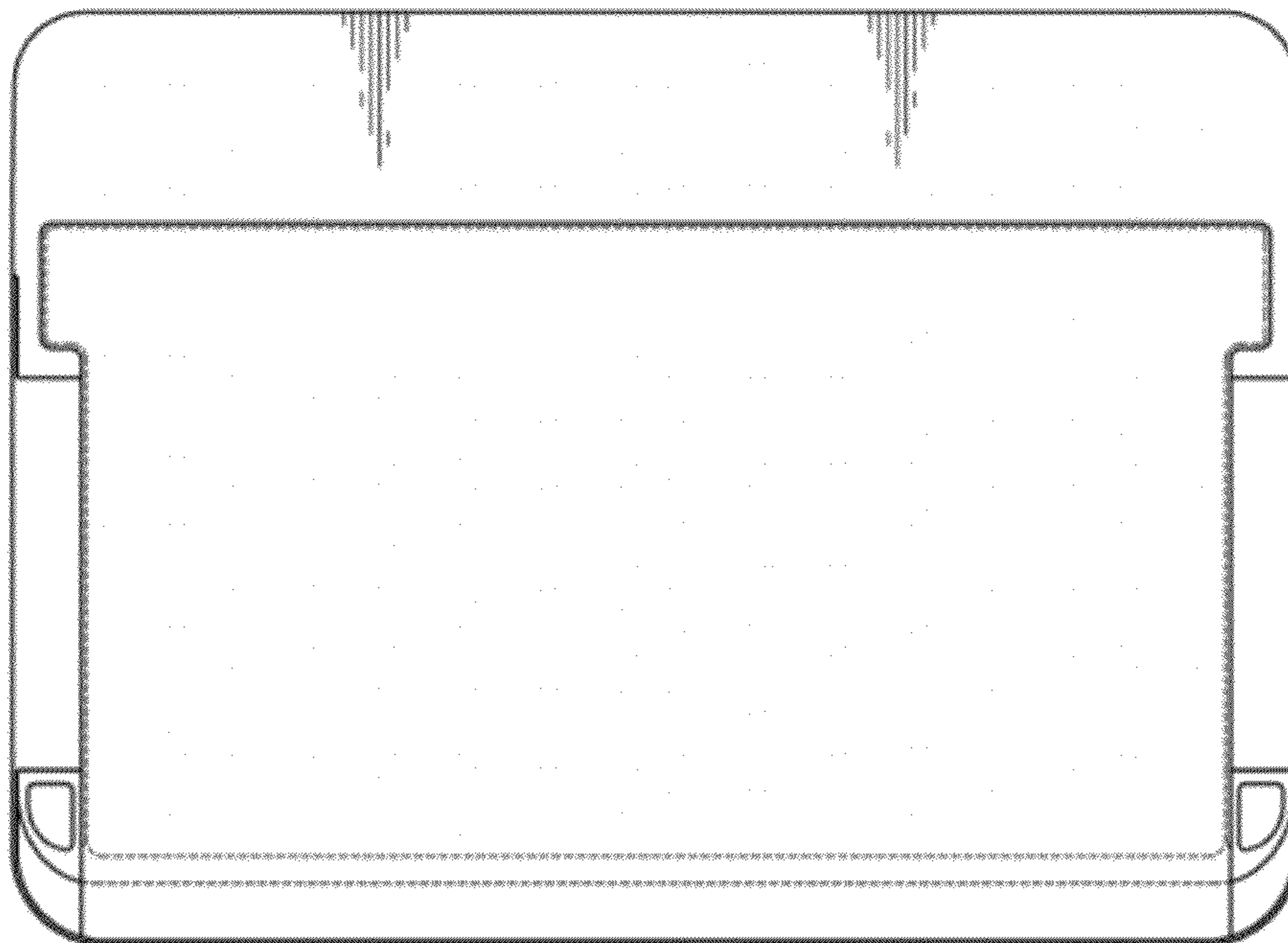

FIG. 8

