



US00D663471S

(12) **United States Design Patent**  
**Bennett et al.**

(10) **Patent No.:** **US D663,471 S**  
(45) **Date of Patent:** **\*\* Jul. 10, 2012**

(54) **LIGHTING DEVICE**

(75) Inventors: **Jason R. Bennett**, Sydney (AU);  
**Timothy J Rugendyke**, Woy Woy (AU);  
**Kenneth G. Bonham**, Glossodia (AU);  
**Peter McMillan**, Naremburn (AU)

(73) Assignee: **Eveready Battery Company, Inc.**, St. Louis, MO (US)

(\*\*) Term: **14 Years**

(21) Appl. No.: **29/391,405**

(22) Filed: **May 9, 2011**

(51) **LOC (9) Cl.** ..... **26-03**

(52) **U.S. Cl.** ..... **D26/93**

(58) **Field of Classification Search** ..... D26/1,  
D26/24, 67, 93-94, 101, 104-110, 113, 118;  
362/3, 153, 186, 217, 255, 257, 277, 317,  
362/351, 353, 362, 363, 382, 431, 433, 458,  
362/806

See application file for complete search history.

(56) **References Cited**

U.S. PATENT DOCUMENTS

D243,415	S	*	2/1977	Larson	.....	D26/105
D307,638	S	*	5/1990	Perkins	.....	D26/104
D525,739	S	*	7/2006	Wu	.....	D26/93
D630,370	S	*	1/2011	Meeker et al.	.....	D26/93
D650,511	S	*	12/2011	Hine et al.	.....	D26/93

\* cited by examiner

*Primary Examiner* — Brian N Vinson

(74) *Attorney, Agent, or Firm* — Michael C. Pophal

(57) **CLAIM**

We claim the ornamental design for a lighting device, as shown and described.

**DESCRIPTION**

FIG. 1 is a front perspective view of the lighting device showing a first embodiment of our new design.

FIG. 2 is a top perspective view thereof.

FIG. 3 is a front view thereof.

FIG. 4 is a rear view thereof.

FIG. 5 is a right side view thereof. The left side view is a mirror image of the right side view.

FIG. 6 is a top view thereof.

FIG. 7 is a bottom view thereof.

FIG. 8 is a front perspective view of the lighting device showing a second embodiment of our new design.

FIG. 9 is a top perspective view thereof.

FIG. 10 is a front view thereof.

FIG. 11 is a rear view thereof.

FIG. 12 is a right side view thereof. The left side view is a mirror image of the right side view.

FIG. 13 is a top view thereof; and,

FIG. 14 is a bottom view thereof.

The broken-line disclosure in the views represents portions of the article in which the claimed design is embodied, but which form no part of the claimed design.

**1 Claim, 9 Drawing Sheets**

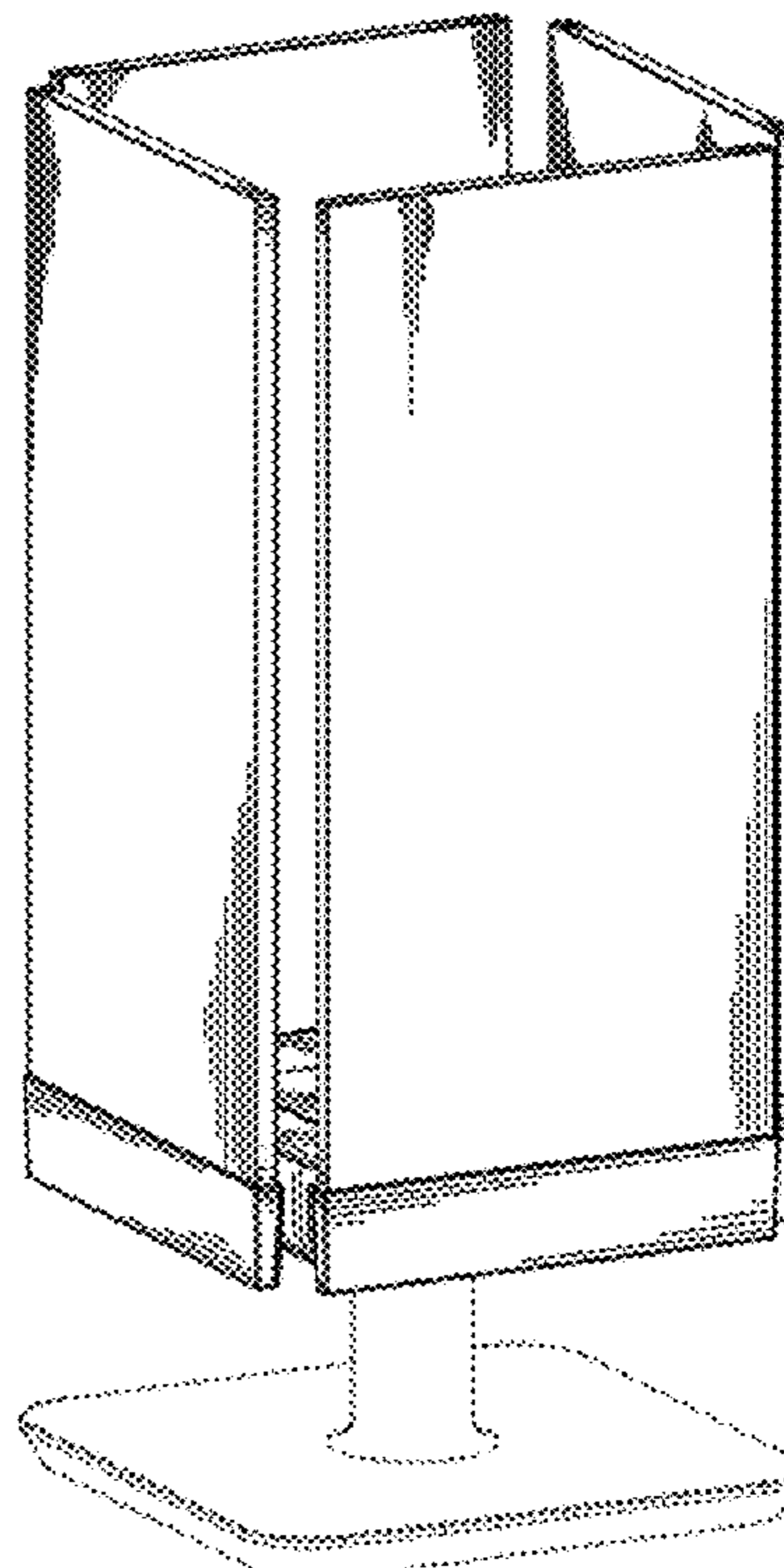
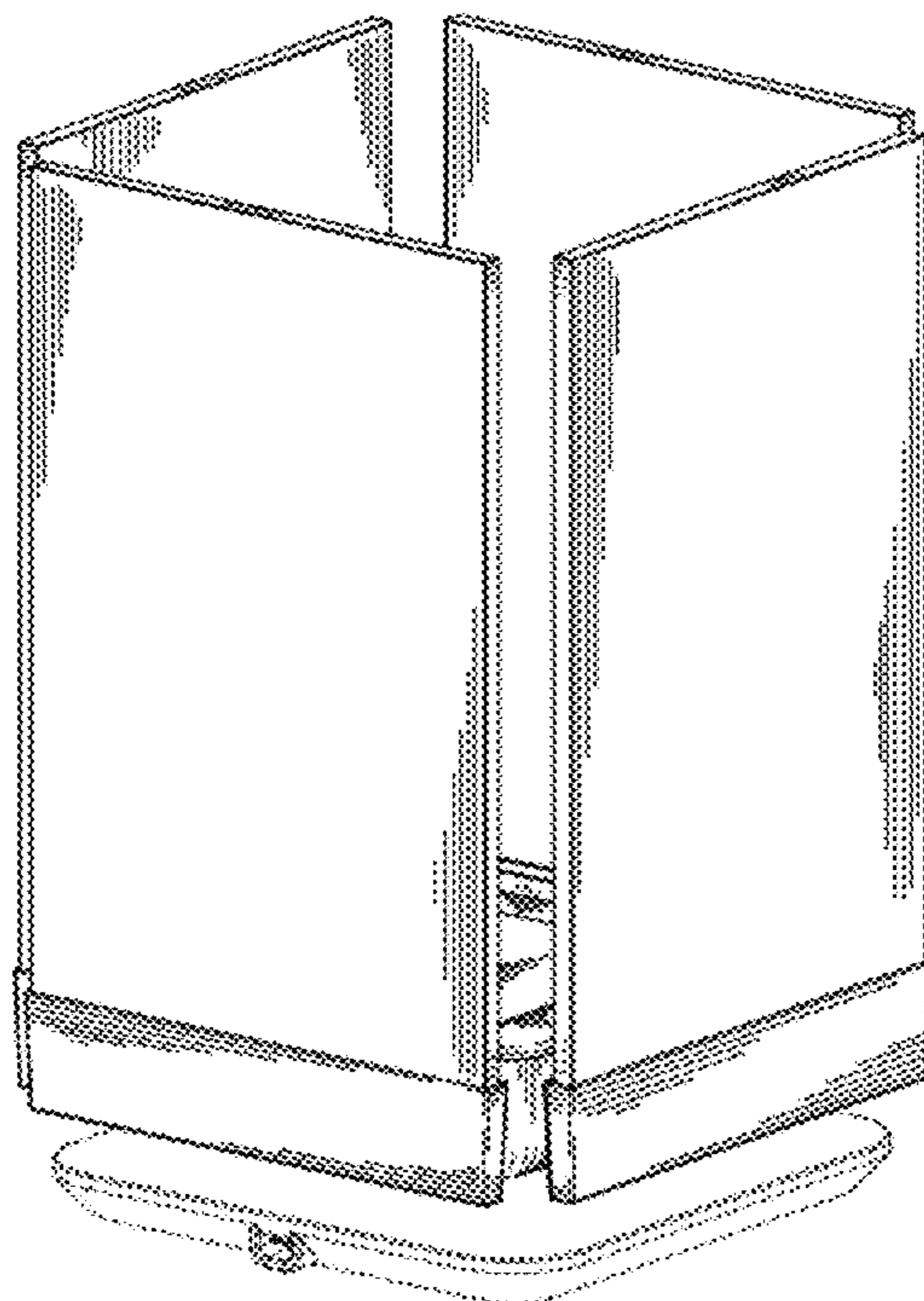

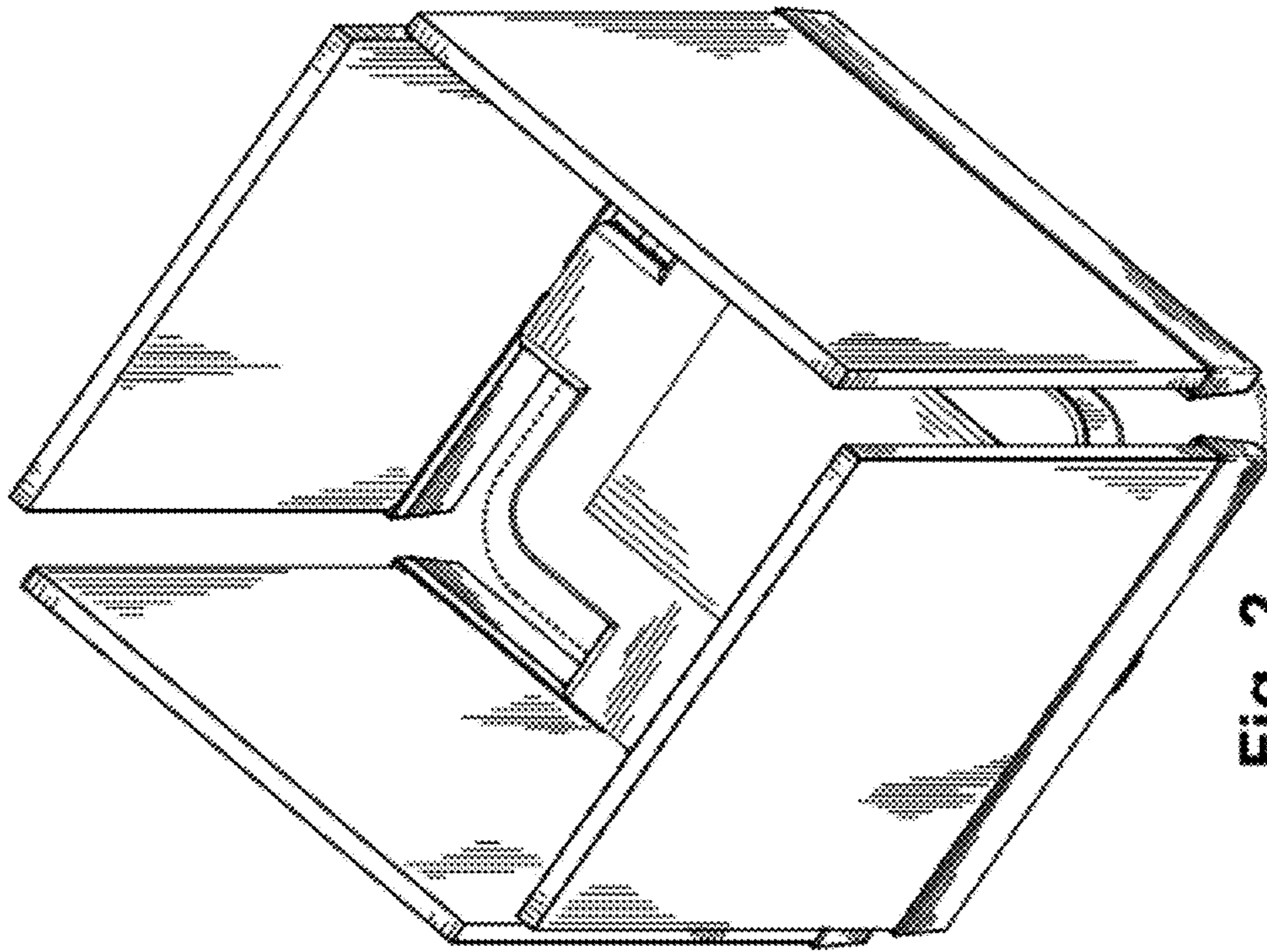

Fig. 2

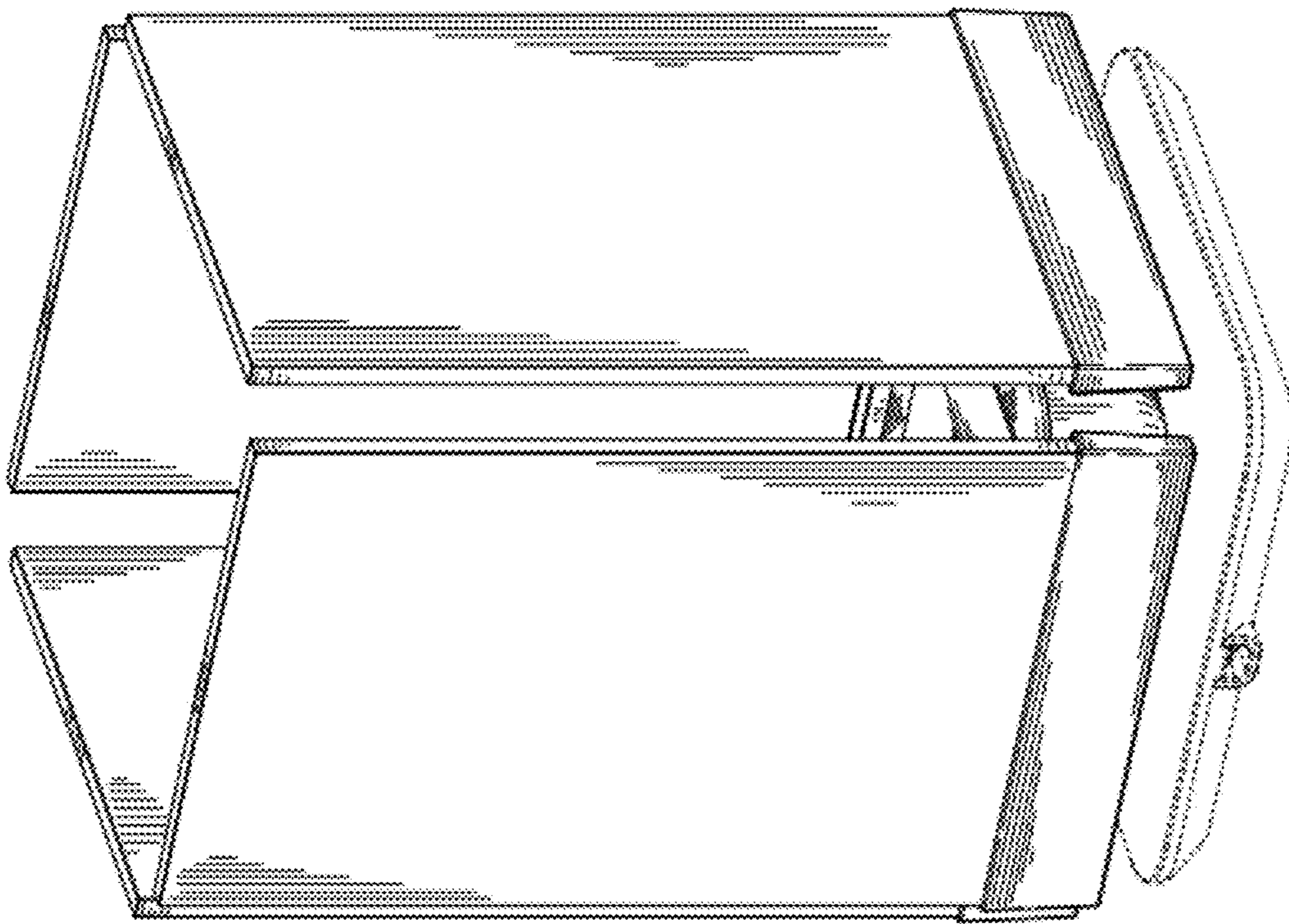

Fig. 1



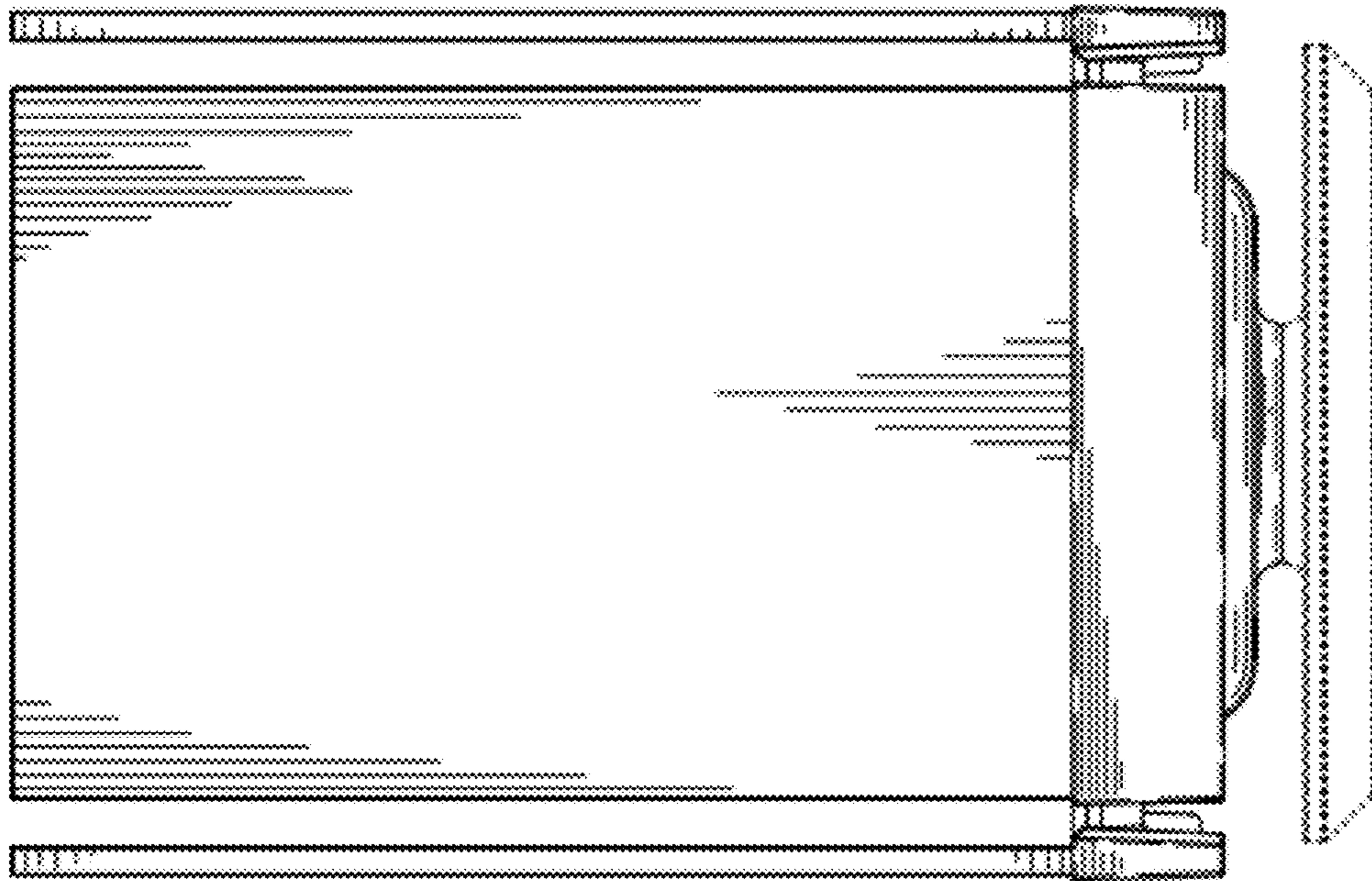

Fig. 4

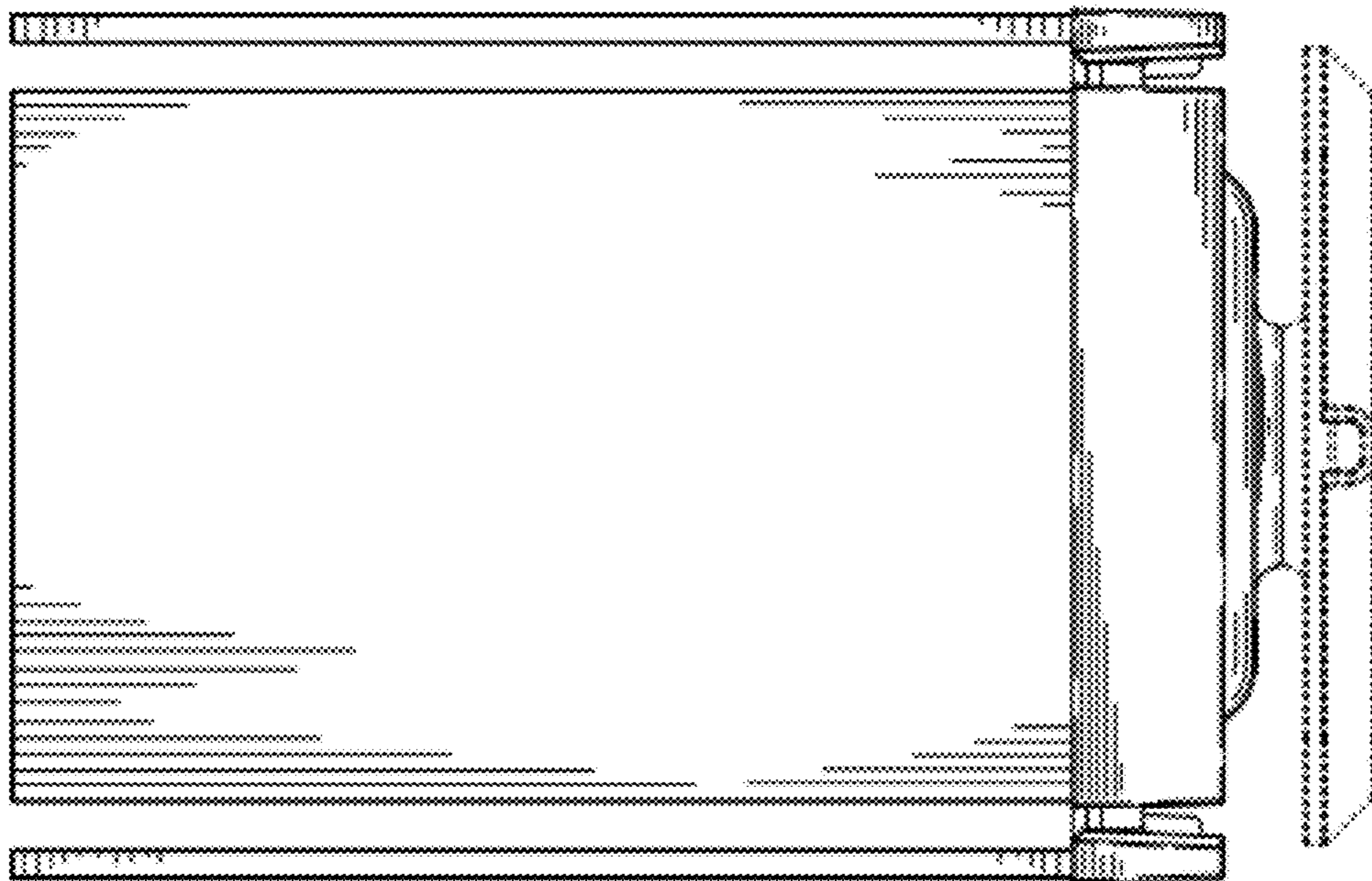

Fig. 3

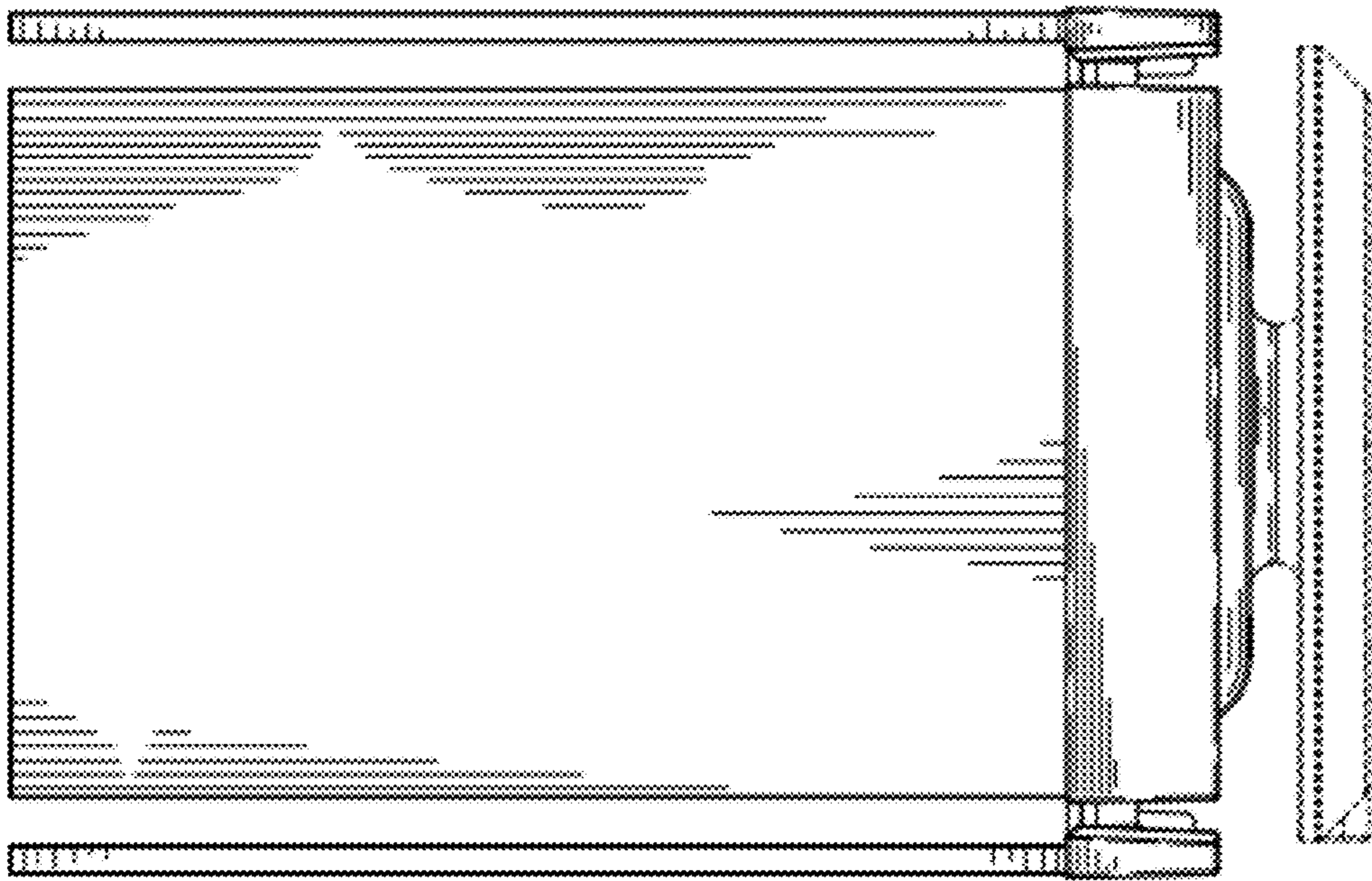

Fig. 5

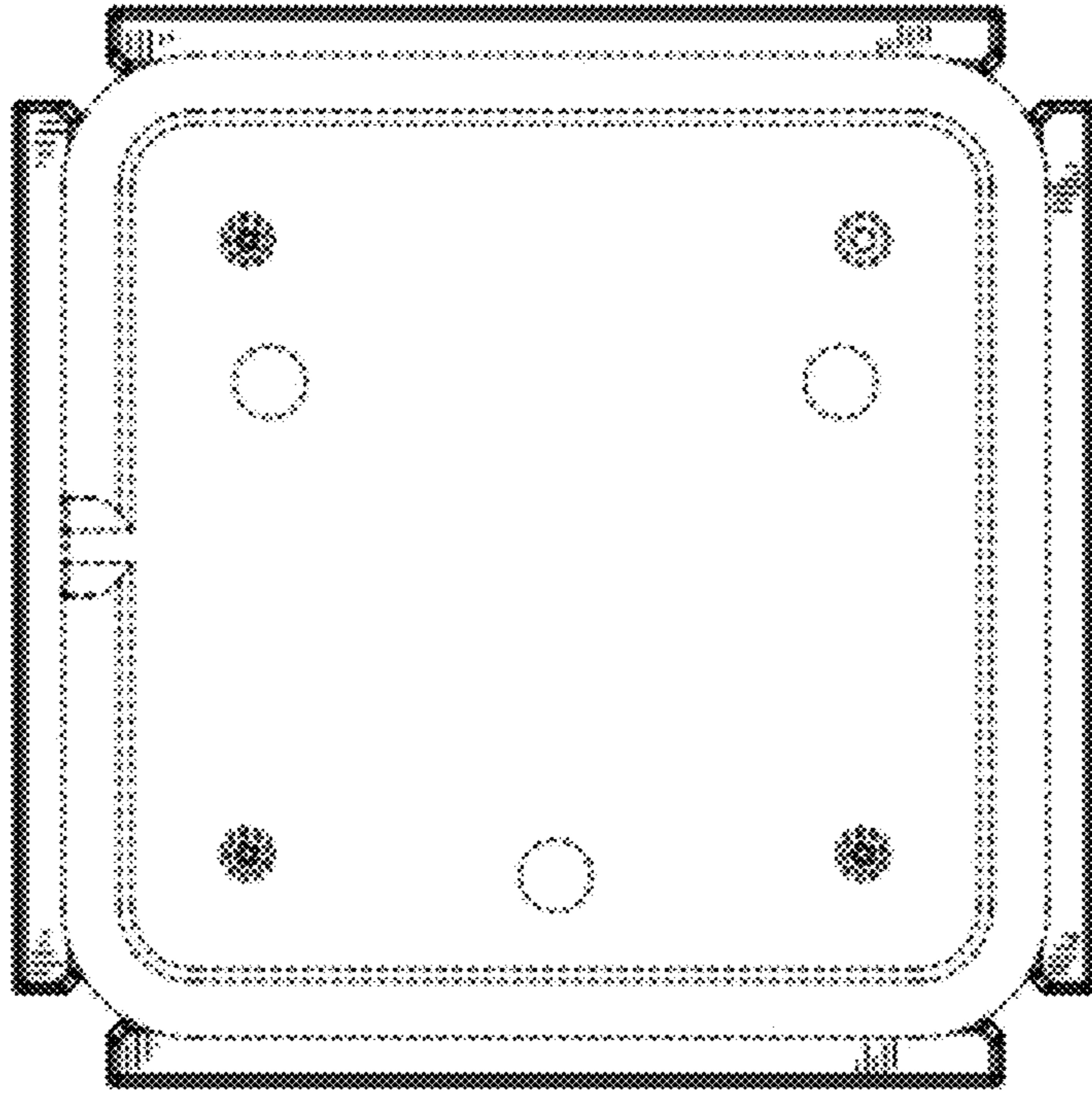

Fig. 6

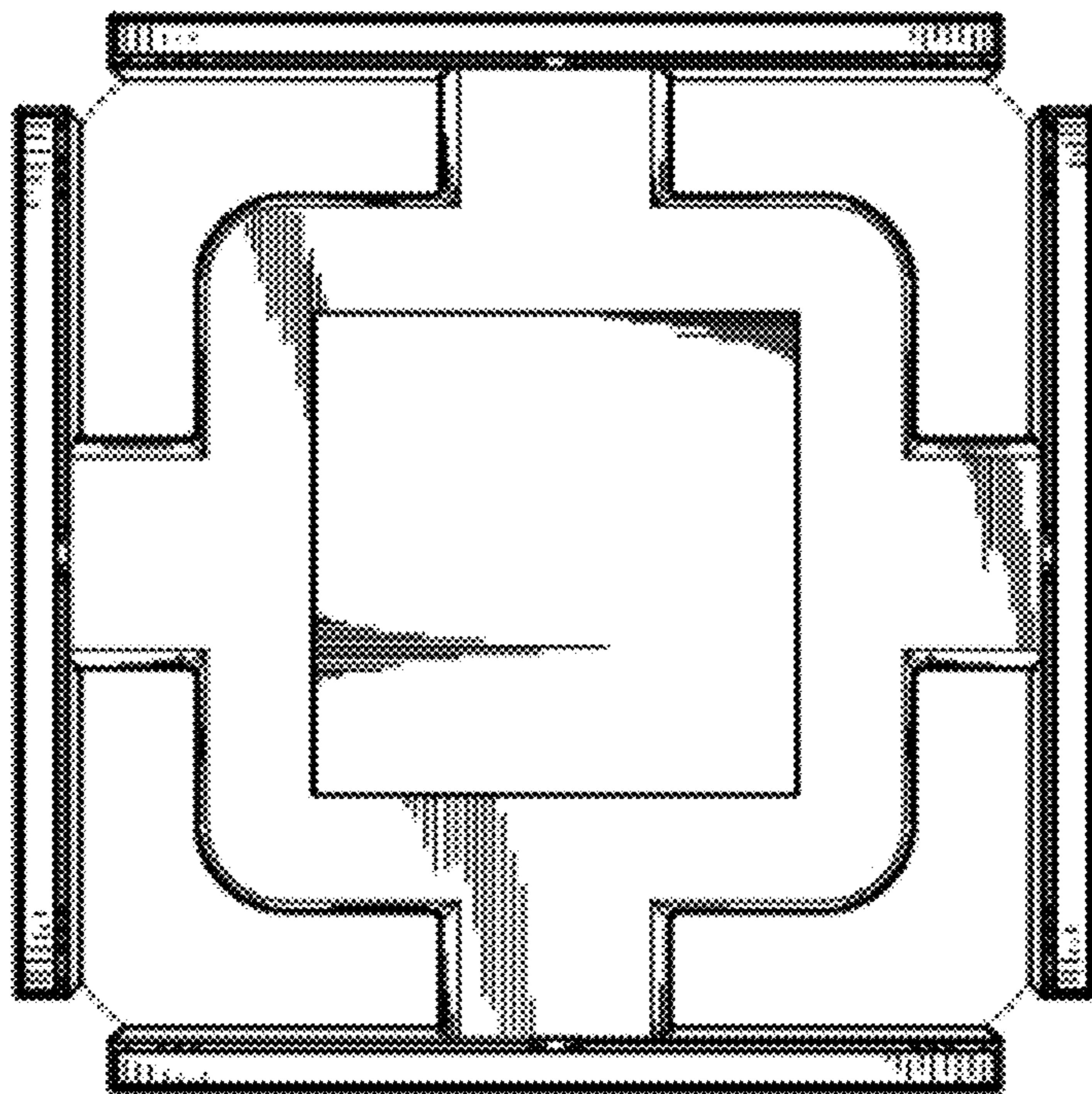
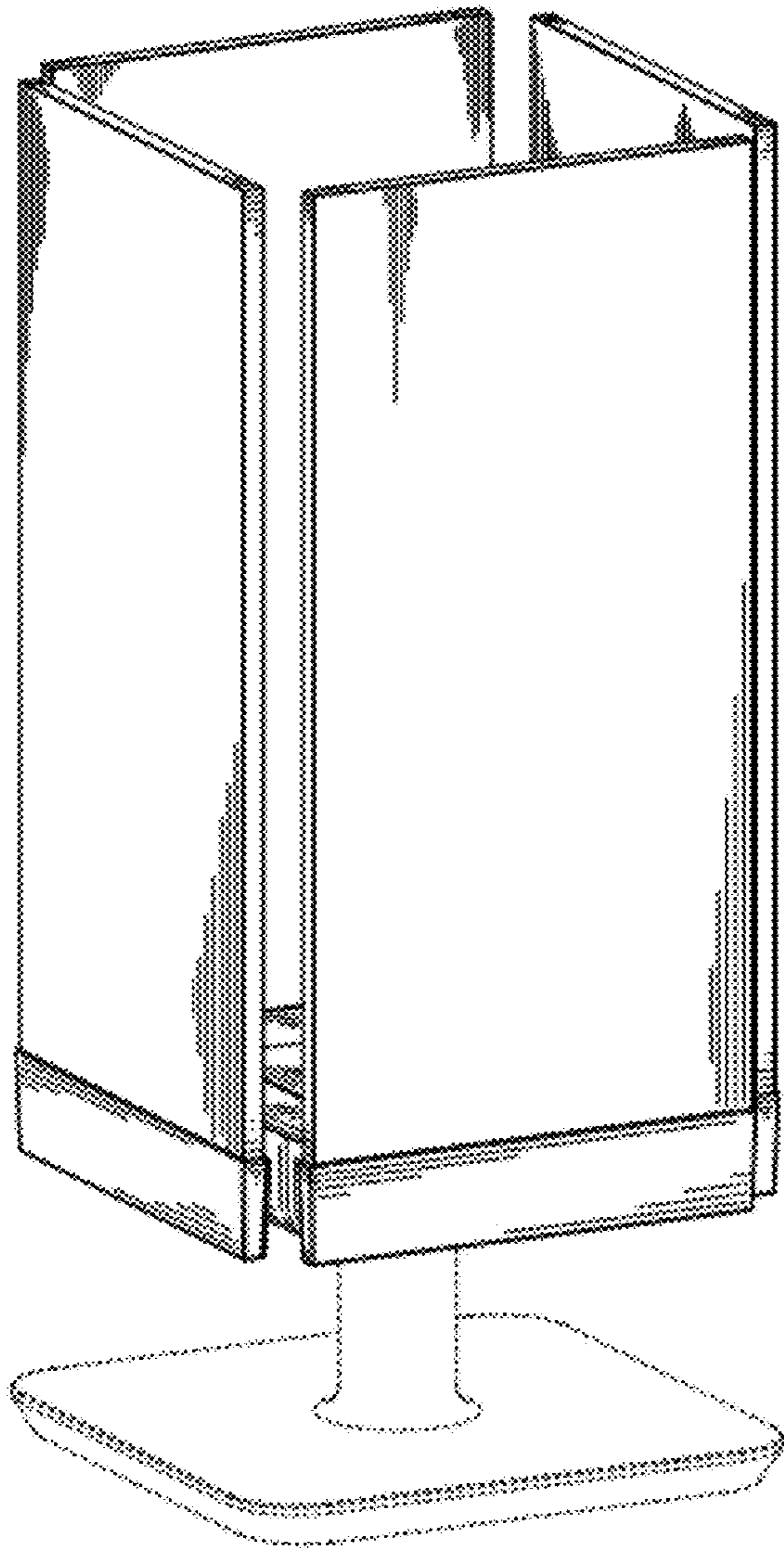
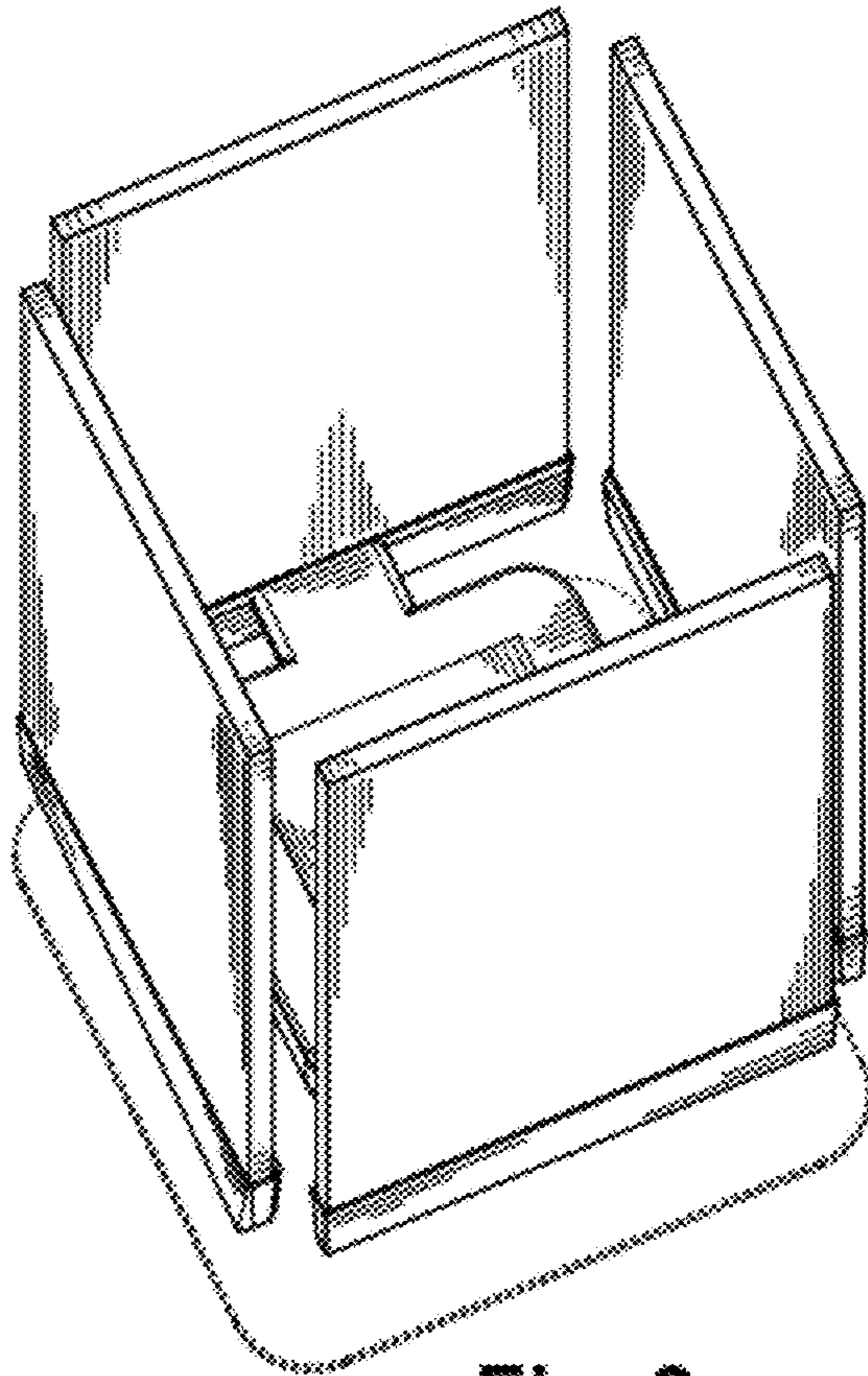

Fig. 7





**Fig. 8**



**Fig. 9**

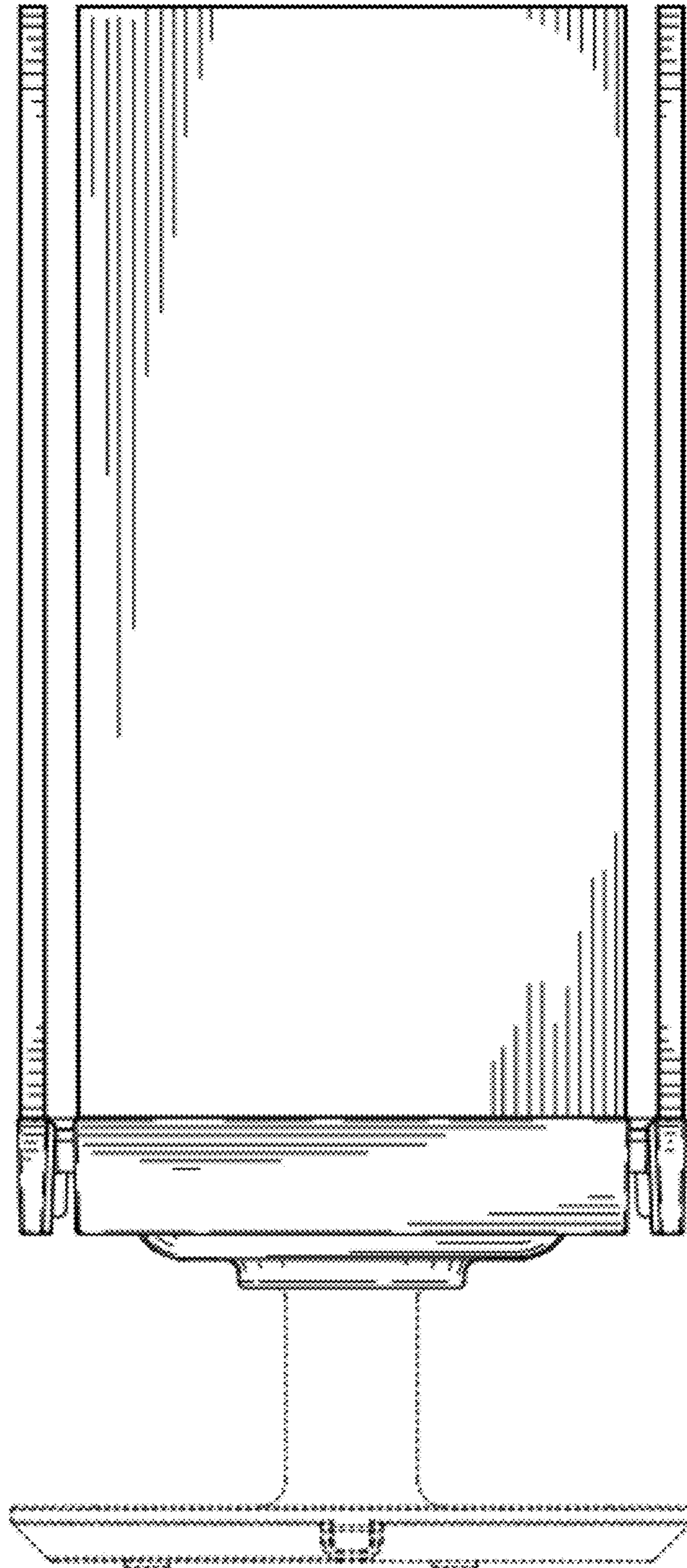

Fig. 10

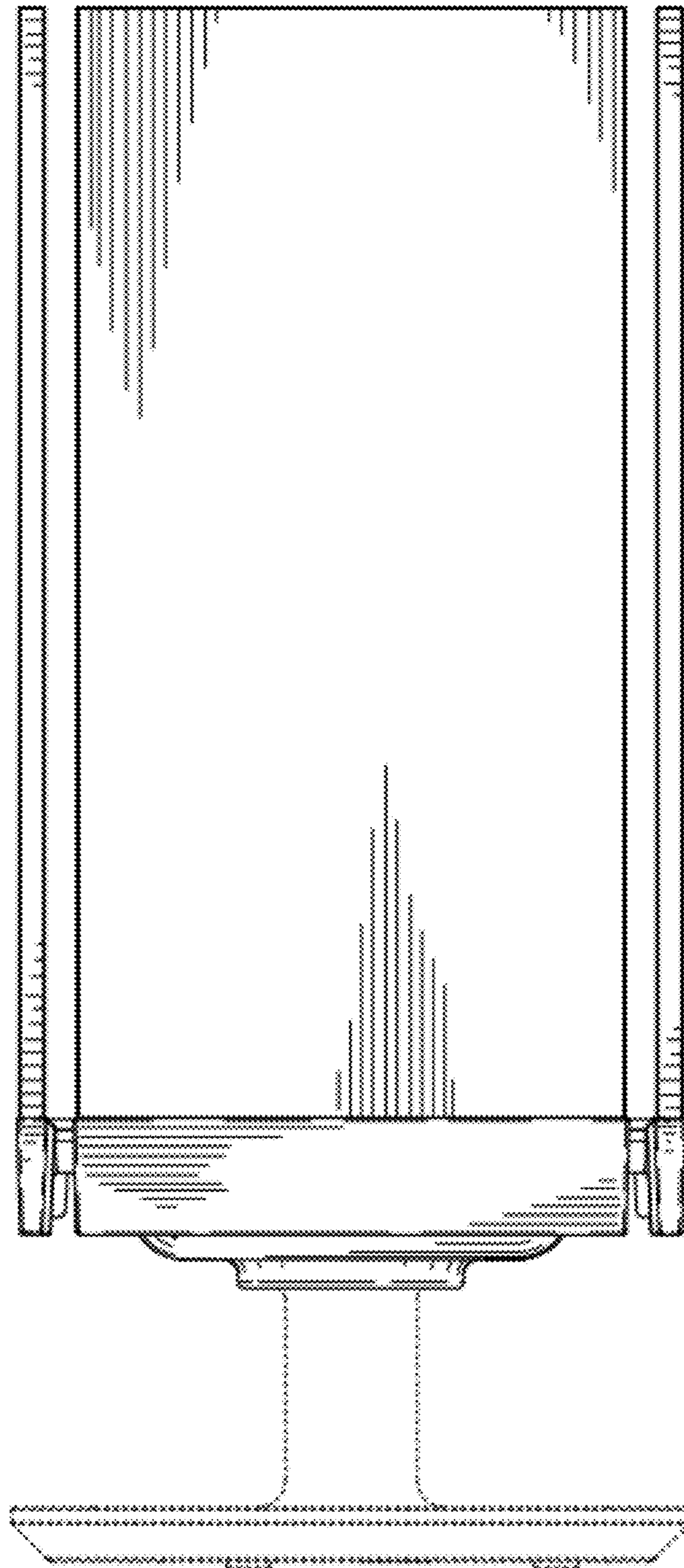

Fig. 11



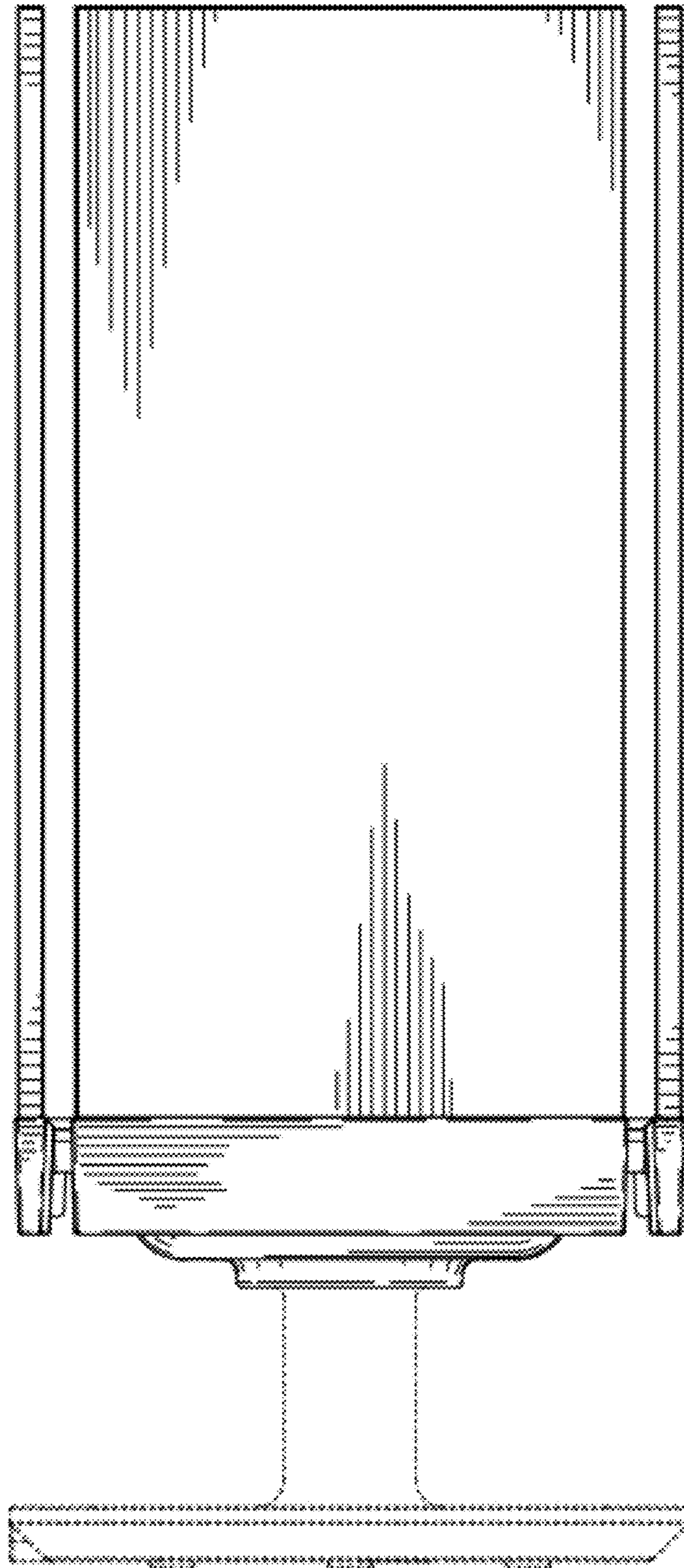
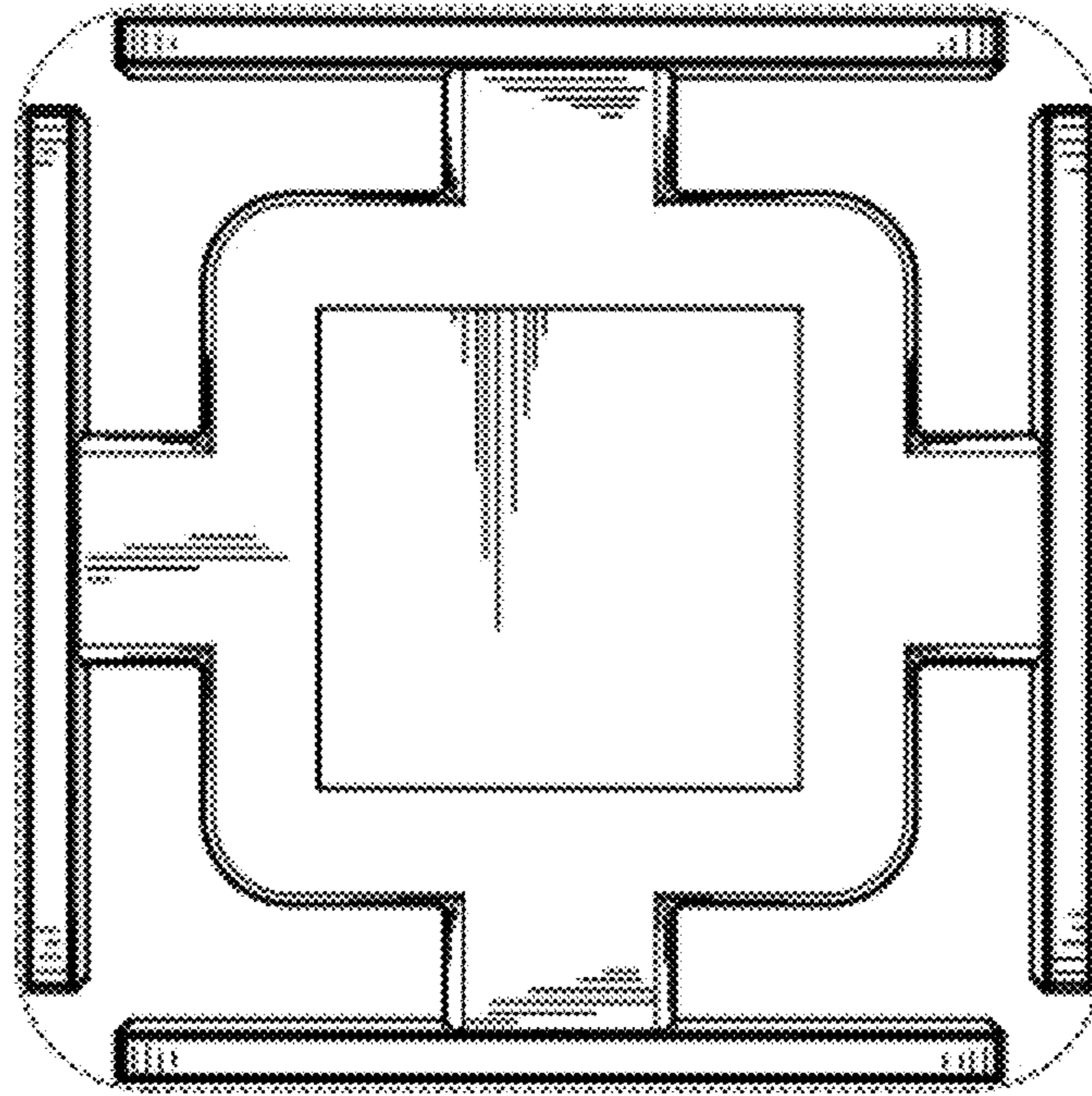
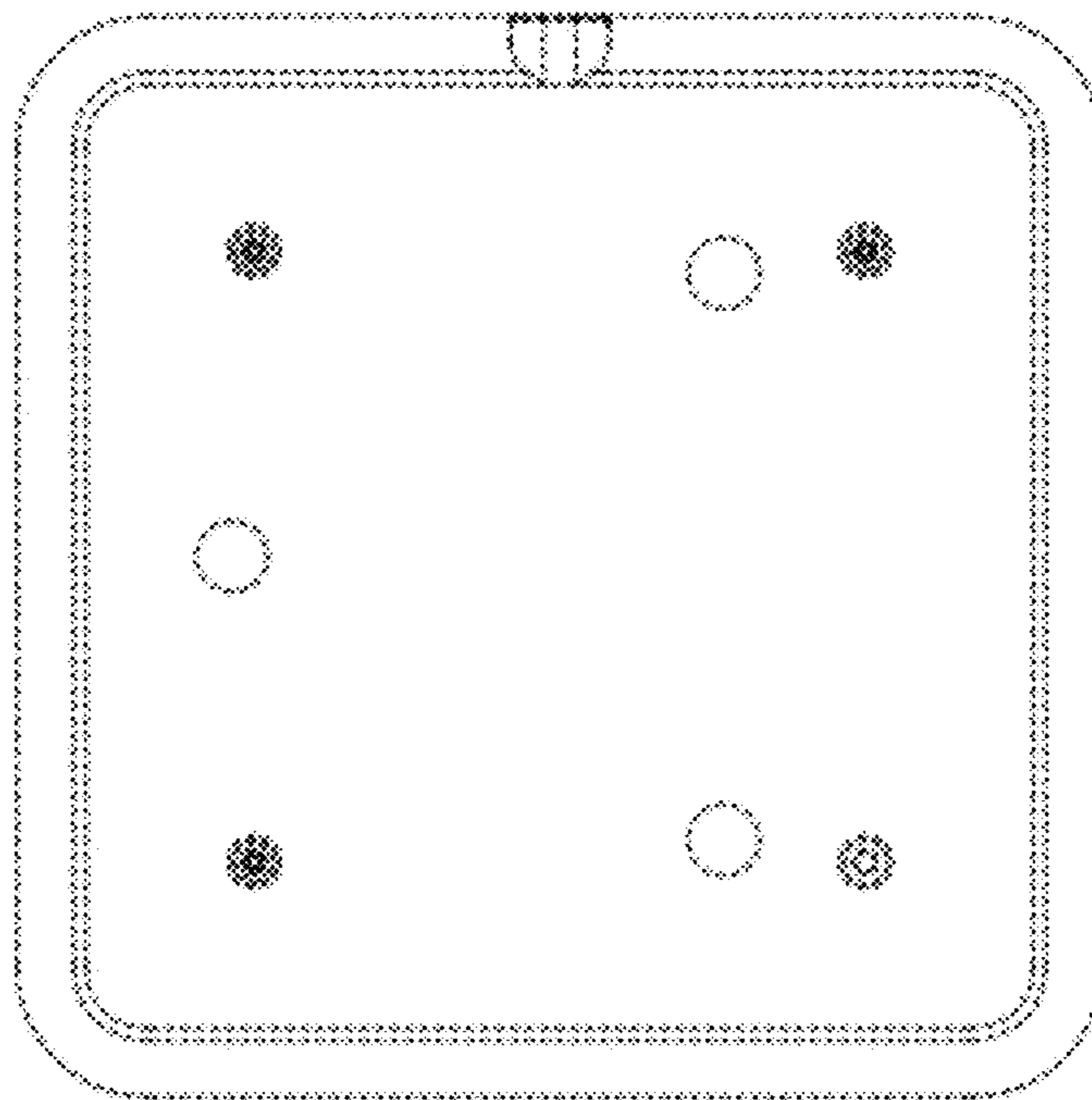

Fig. 12



**Fig. 13**



**Fig. 14**