

US00D663448S

(12) **United States Design Patent**
Kim et al.

(10) **Patent No.:** **US D663,448 S**
(45) **Date of Patent:** **** Jul. 10, 2012**

(54) **LED LAMP**

(75) Inventors: **Jihoo Kim**, Seoul (KR); **Tae Young Choi**, Seoul (KR); **Dong Nyung Lim**, Seoul (KR); **Sung Ho Kim**, Seoul (KR); **Cheonjoo Kim**, Seoul (KR)

(73) Assignee: **LG Innotek Co., Ltd.**, Seoul (KR)

(**) Term: **14 Years**

(21) Appl. No.: **29/390,035**

(22) Filed: **Apr. 19, 2011**

(30) **Foreign Application Priority Data**

Oct. 22, 2010 (KR) 30-2010-0045762

(51) **LOC (9) Cl.** **26-04**

(52) **U.S. Cl.** **D26/2**

(58) **Field of Classification Search** D26/1-4;
313/313, 315, 316, 317, 318, 493; 315/52,
315/53, 56, 57, 58

See application file for complete search history.

(56) **References Cited**

U.S. PATENT DOCUMENTS

D600,367 S *	9/2009	Bertram et al.	D26/2
D601,278 S *	9/2009	Takahashi	D26/2
D616,120 S *	5/2010	Wada et al.	D26/2
D617,915 S *	6/2010	Wada et al.	D26/2
D617,918 S *	6/2010	Yamamoto et al.	D26/2

FOREIGN PATENT DOCUMENTS

KR	30-0572948-0000	9/2010
KR	30-0572948-0001	11/2010

OTHER PUBLICATIONS

Korean Office Action for 30-2010-0045762 dated Dec. 14, 2011, citing the above reference(s).

* cited by examiner

Primary Examiner — Marcus Jackson

(74) *Attorney, Agent, or Firm* — Lowe Hauptman Ham & Berner, LLP

(57) **CLAIM**

The ornamental design for a LED lamp, as shown and described.

DESCRIPTION

FIG. 1 is a perspective view of a LED lamp showing my/our new design;
FIG. 2 is a front elevational view thereof;
FIG. 3 is a rear elevational view thereof;
FIG. 4 is a left side elevational view thereof;
FIG. 5 is a right side elevational view thereof;
FIG. 6 is a top plan view thereof;
FIG. 7 is a bottom plan view thereof; and,
FIG. 8 is a cross-sectional view of FIG. 1.
LED is installed in the light emitting part.

1 Claim, 5 Drawing Sheets

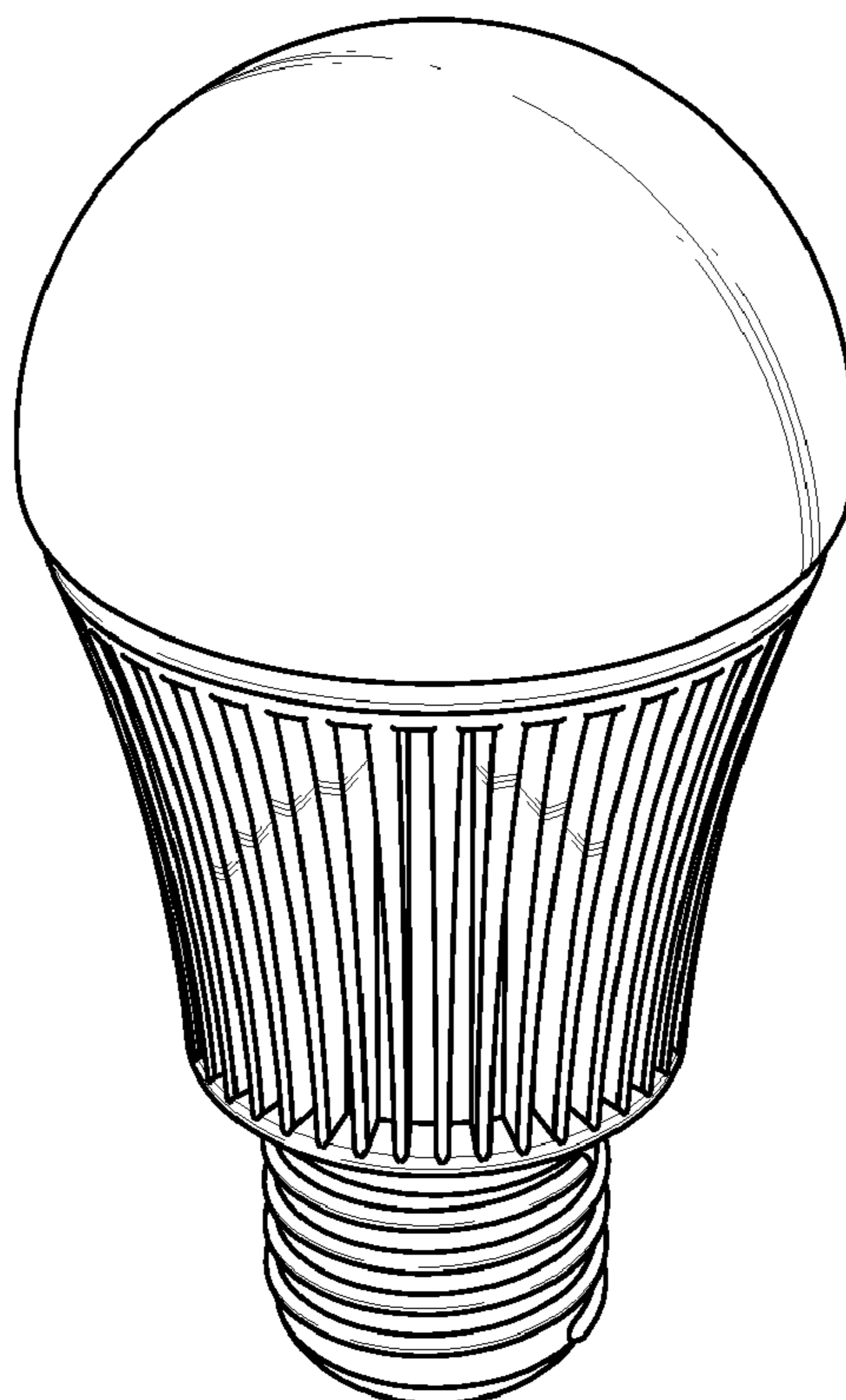

FIG. 1

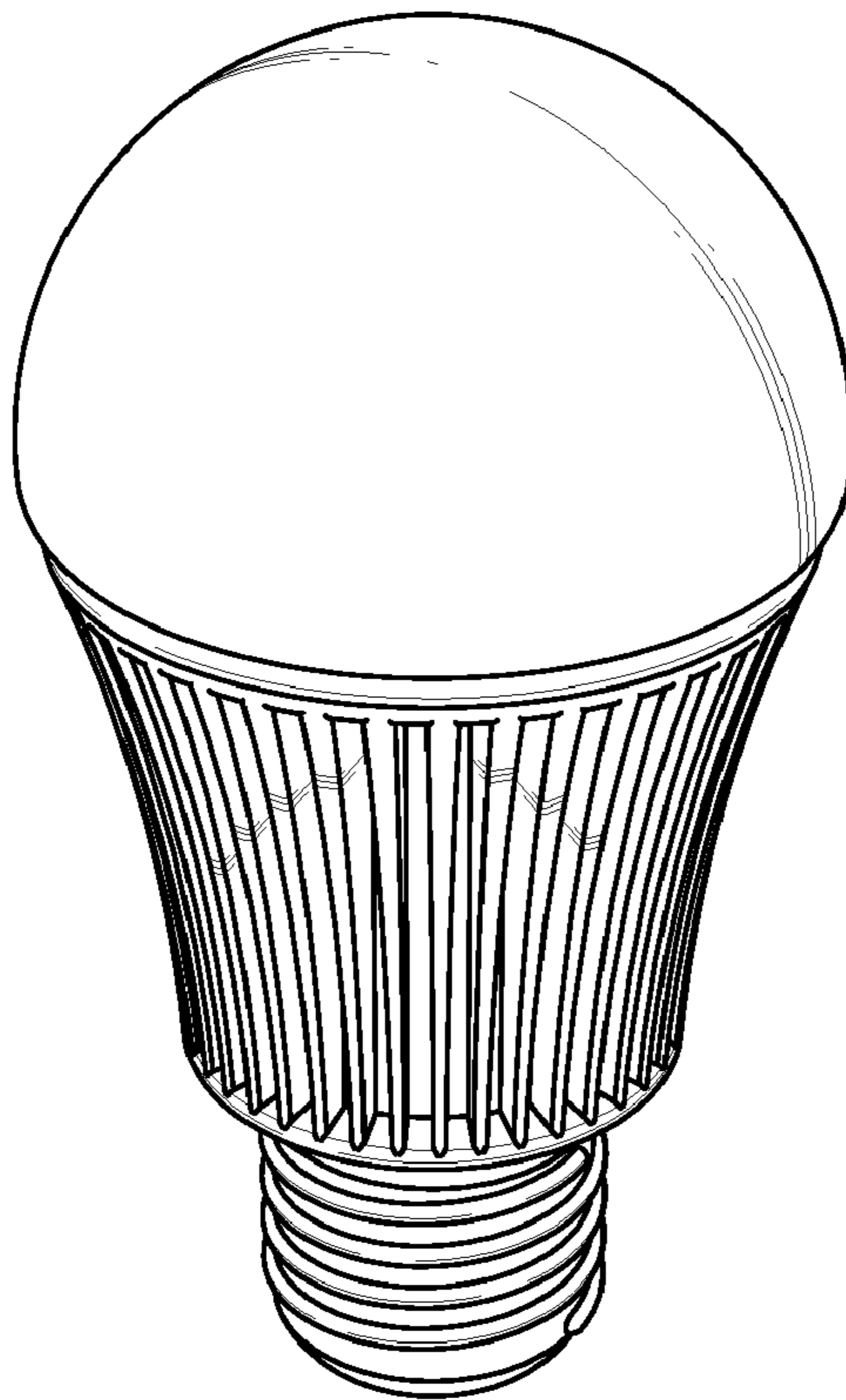

FIG. 2

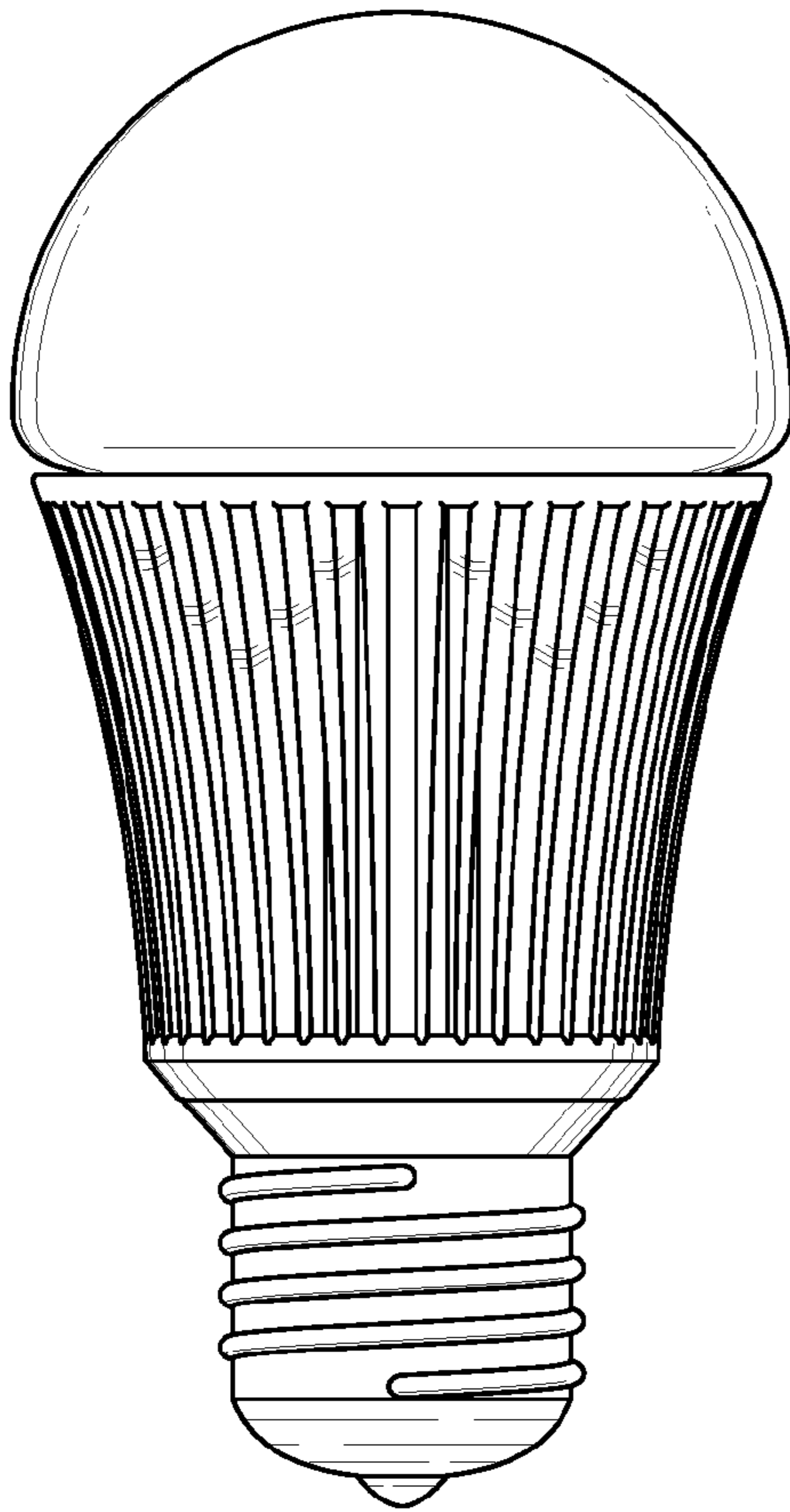

FIG. 3

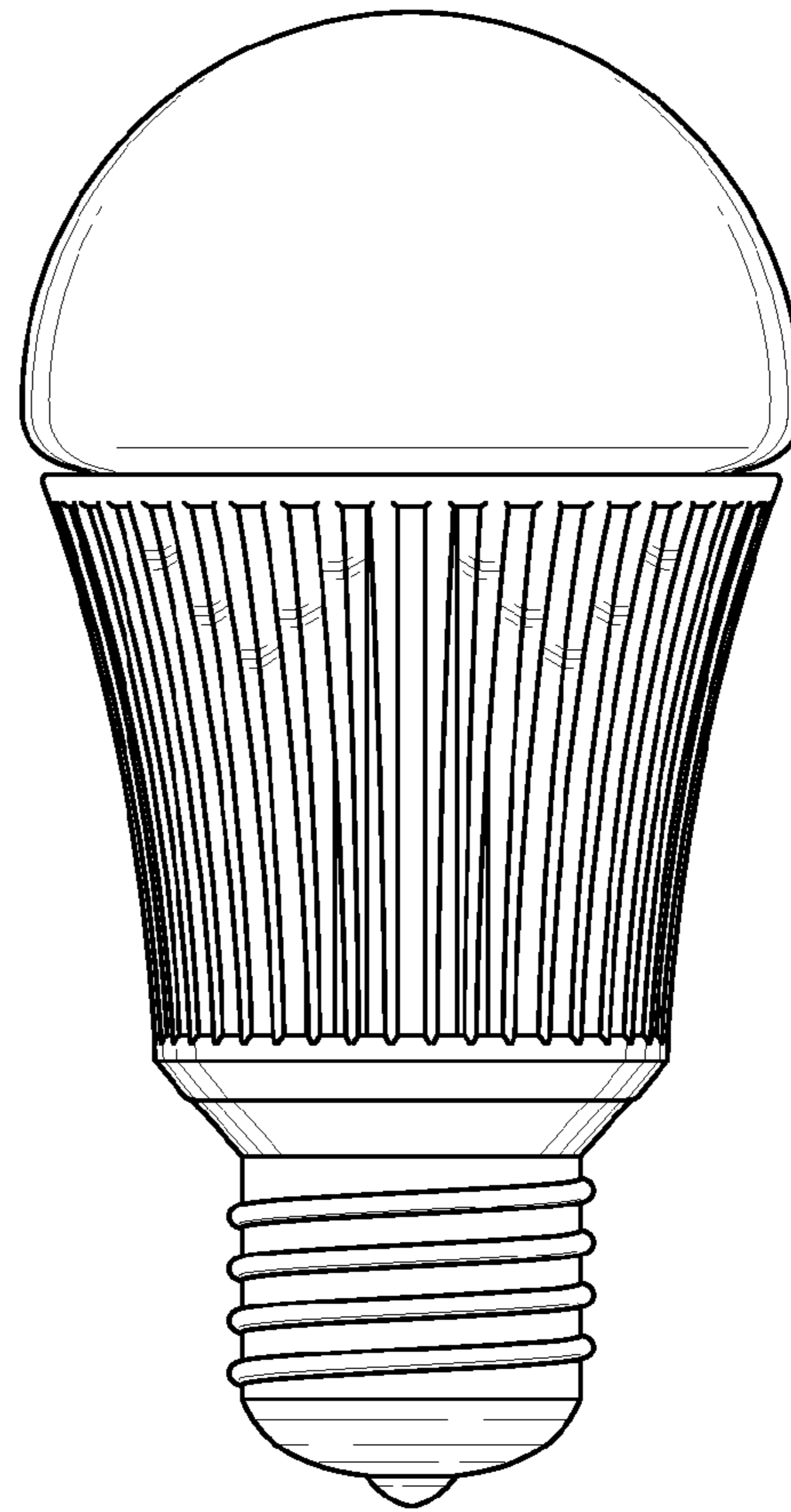

FIG. 4

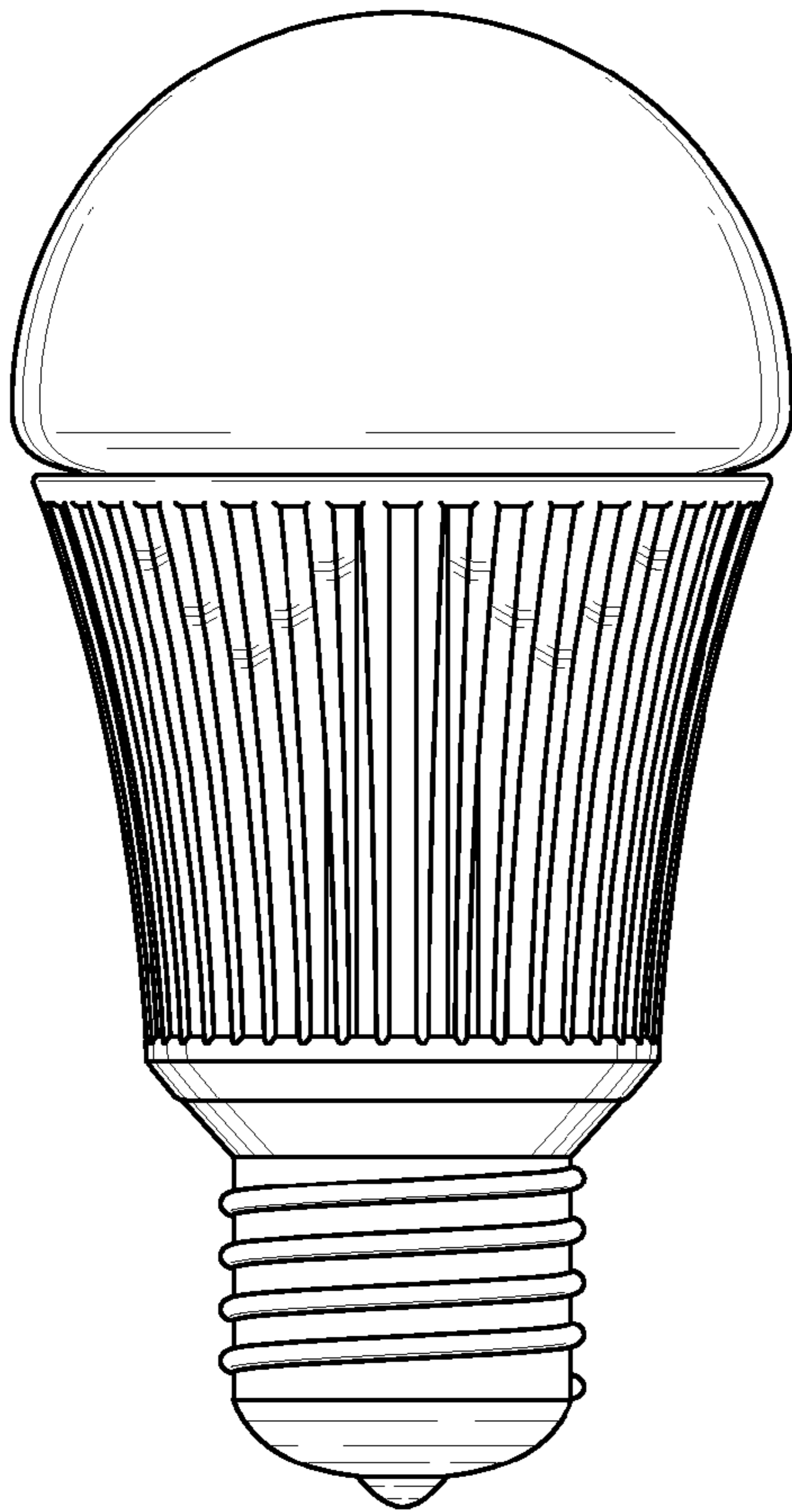

FIG. 5

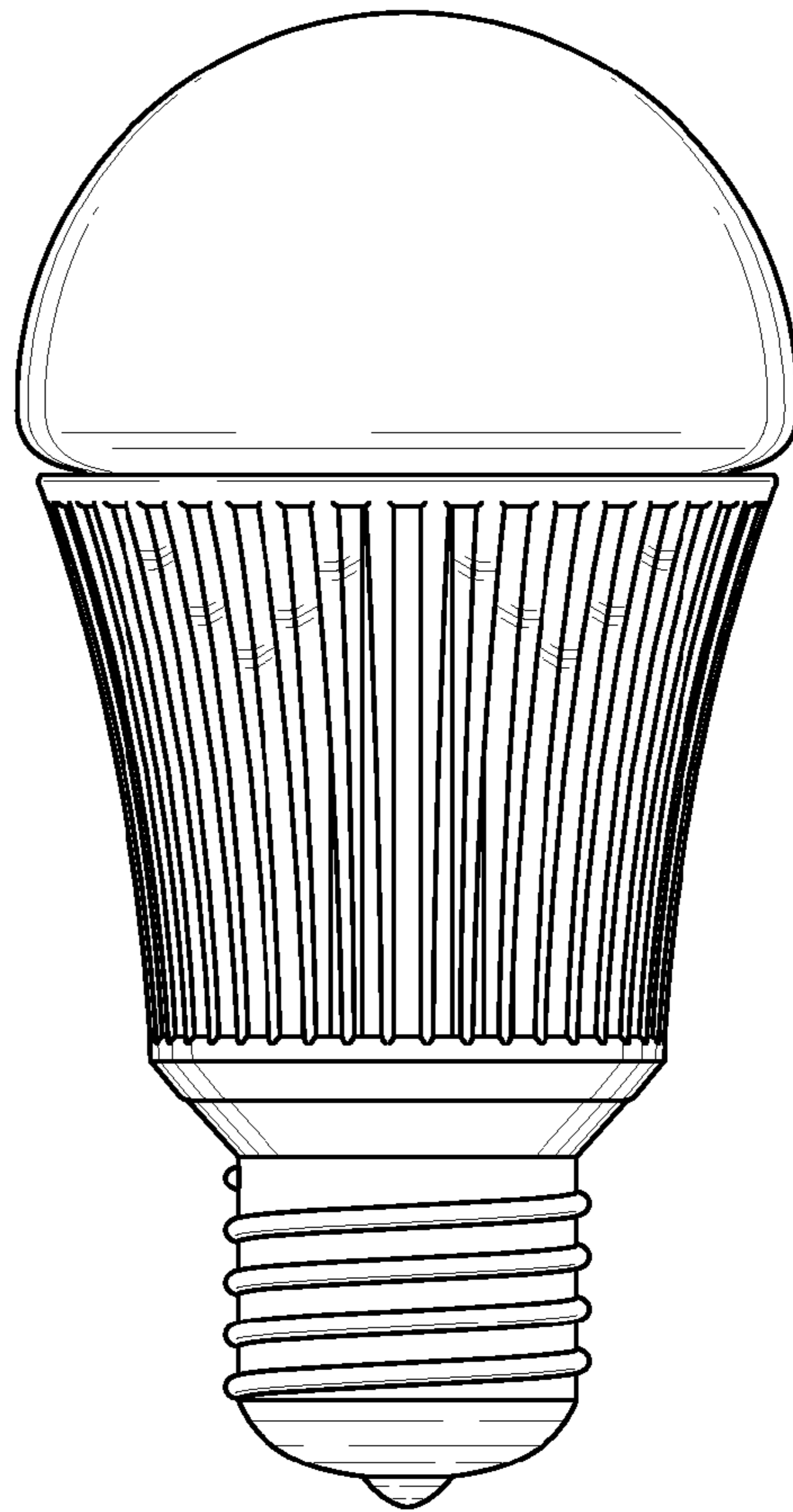

FIG. 6

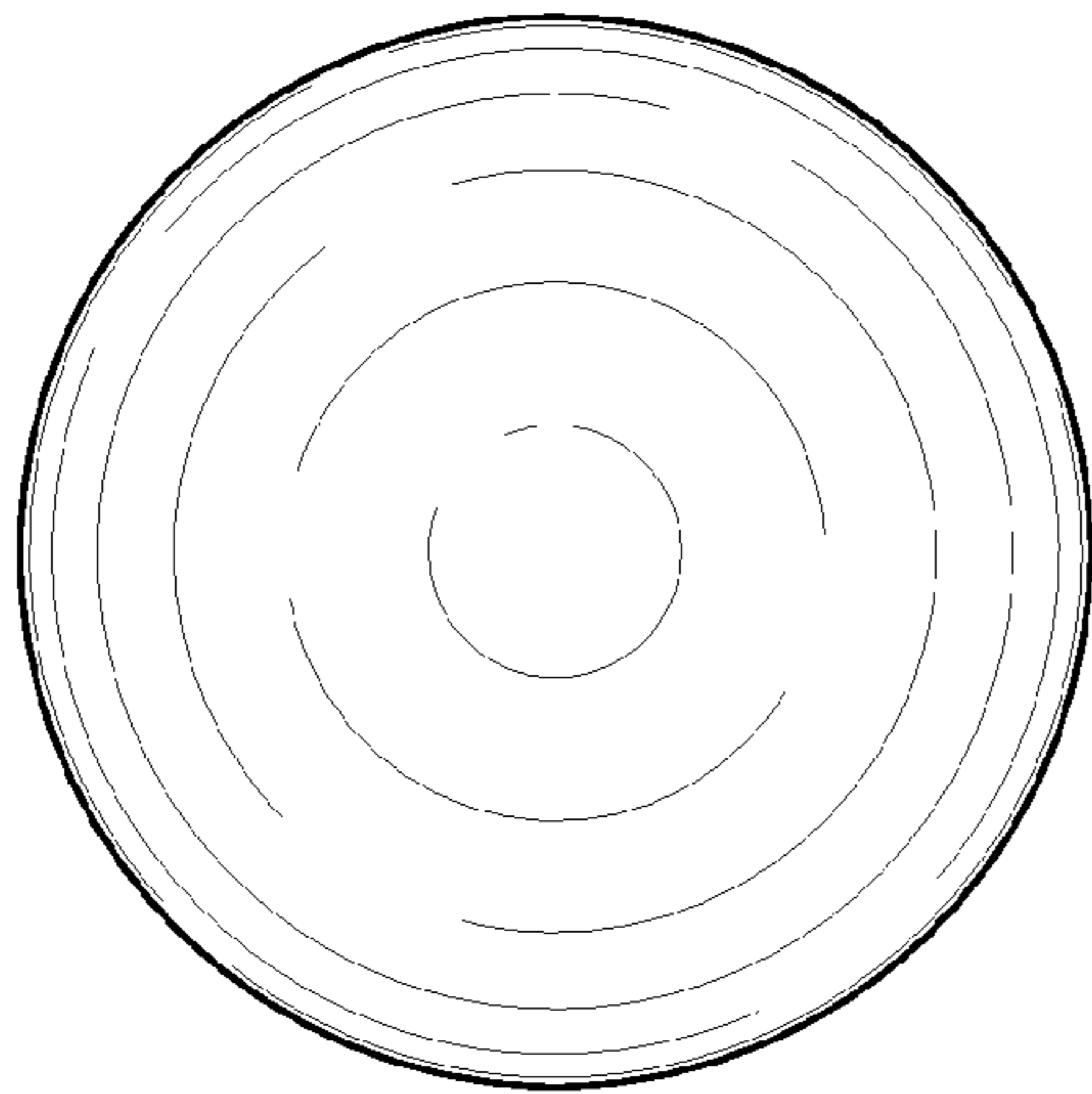

FIG. 7

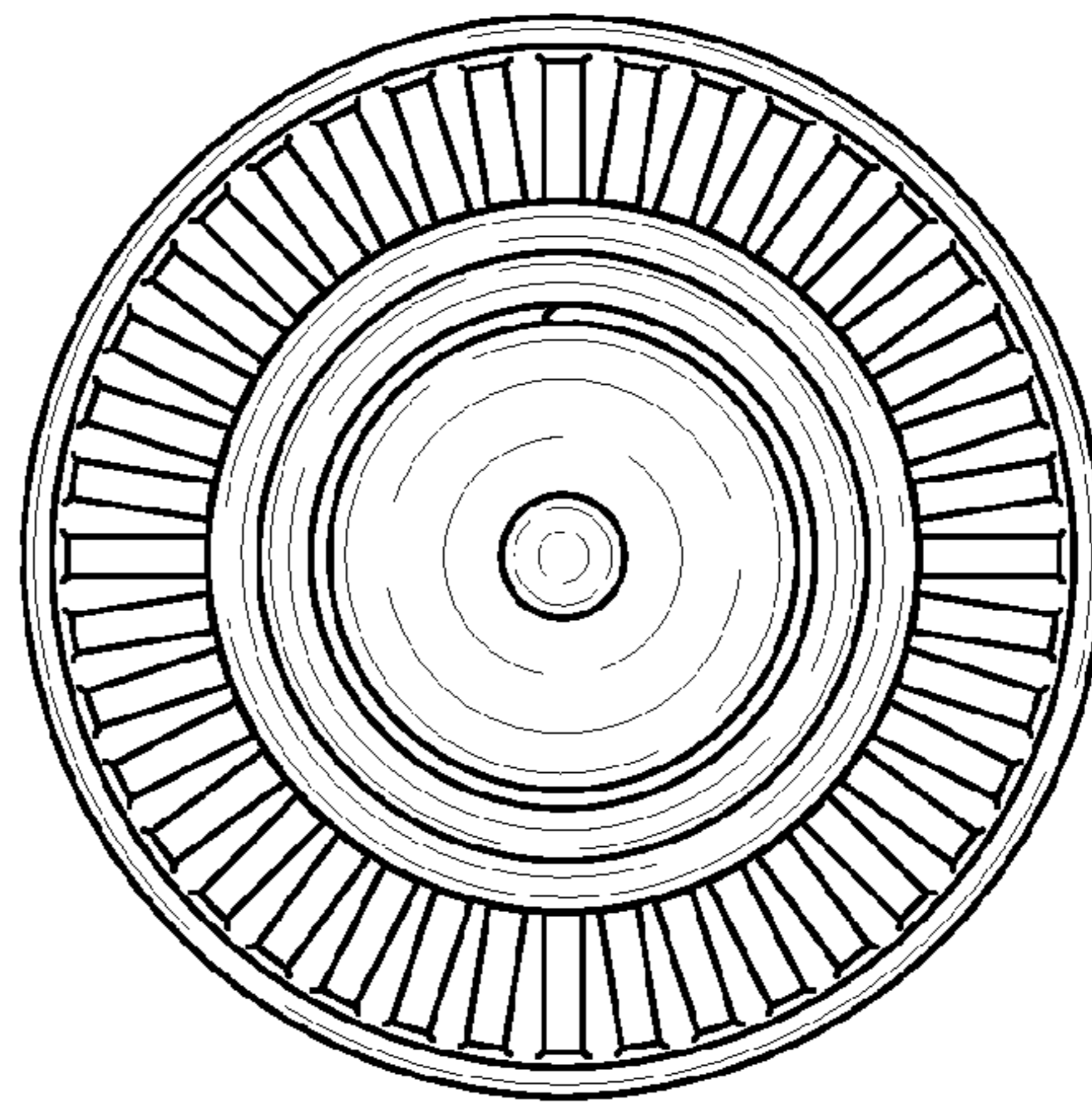

FIG. 8

