



US00D663383S

(12) **United States Design Patent**
Su

(10) **Patent No.:** **US D663,383 S**
(45) **Date of Patent:** **** Jul. 10, 2012**

(54) **WALL MOUNTABLE FAUCET**

(75) Inventor: **Sophie Su**, Shanghai (CN)
(73) Assignee: **Kohler (China) Investment Co., Ltd.**,
Shanghai (CN)
(**) Term: **14 Years**

(21) Appl. No.: **29/391,671**

(22) Filed: **May 11, 2011**

(51) **LOC (9) Cl.** **23-02**

(52) **U.S. Cl.** **D23/239; D23/255**

(58) **Field of Classification Search** D23/238,
D23/241–242, 255, 257, 239–240; 4/675–378;
137/801

See application file for complete search history.

(56) **References Cited**

U.S. PATENT DOCUMENTS

D224,403	S	*	7/1972	Jenner	D23/238
4,606,370	A	*	8/1986	Geipel et al.	137/801
4,823,409	A		4/1989	Gaffney et al.		
D319,685	S	*	9/1991	Kohler et al.	D23/255
D337,371	S	*	7/1993	Levien	D23/255
D351,217	S	*	10/1994	Lu	D23/241
D352,547	S		11/1994	McKeone		
D353,187	S	*	12/1994	Formgren	D23/241
D400,647	S	*	11/1998	Lobermeier	D23/241
D448,066	S	*	9/2001	Zetsche	D23/241
D586,885	S		2/2009	Schoenherr et al.		
D590,916	S		4/2009	Schoenherr et al.		
D599,883	S		9/2009	Tippens		
D604,803	S		11/2009	Schoenherr et al.		
D608,418	S		1/2010	Schoenherr et al.		

OTHER PUBLICATIONS

Office for Harmonization in the Internal Market; EU Community Design for Showers for Sanitary Purposes; Reg. No. 000324223-0001; Apr. 8, 2005; 4 pages.

Office for Harmonization in the Internal Market; EU Community Design for Sanitary Fittings; Reg. No. 000640354-0003; Dec. 19, 2006; 4 pages.

* cited by examiner

Primary Examiner — Robert Delehanty

(74) *Attorney, Agent, or Firm* — Foley & Lardner LLP

(57) **CLAIM**

I claim the ornamental design for a wall mountable faucet, as shown and described.

DESCRIPTION

FIG. 1 is a top perspective view of an embodiment of the claimed design;

FIG. 2 is a front elevation view of the claimed design of FIG. 1;

FIG. 3 is a rear elevation view of the claimed design of FIG. 1;

FIG. 4 is a left-side elevation view of the claimed design of FIG. 1;

FIG. 5 is a right-side elevation view of the claimed design of FIG. 1;

FIG. 6 is a top plan view of the claimed design of FIG. 1; and, FIG. 7 is a bottom plan view of the claimed design of FIG. 1.

The ornamental design which is claimed is shown in solid lines in the drawings. The broken lines in the drawings are for illustrative purposes only and form no part of the claimed design.

1 Claim, 7 Drawing Sheets

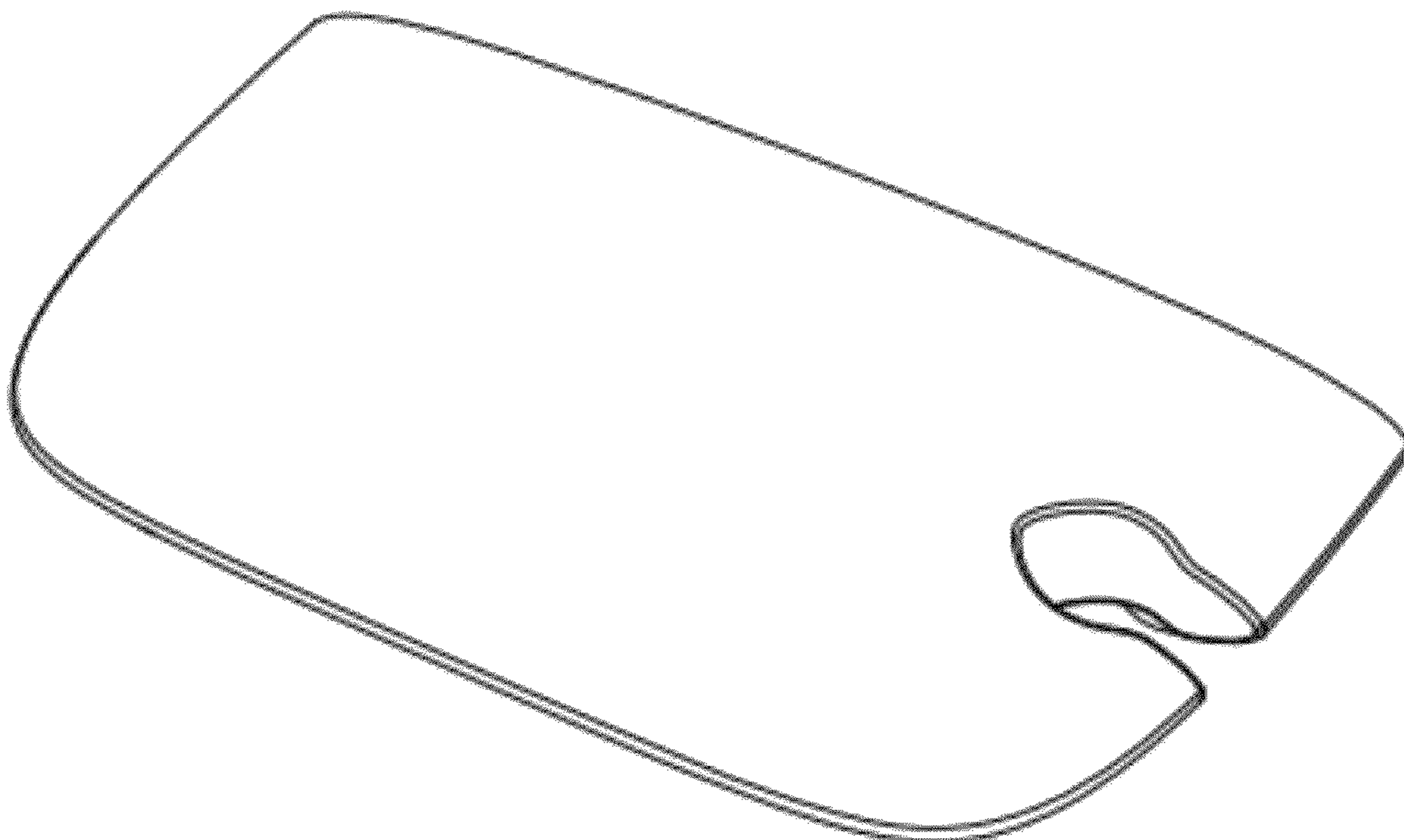

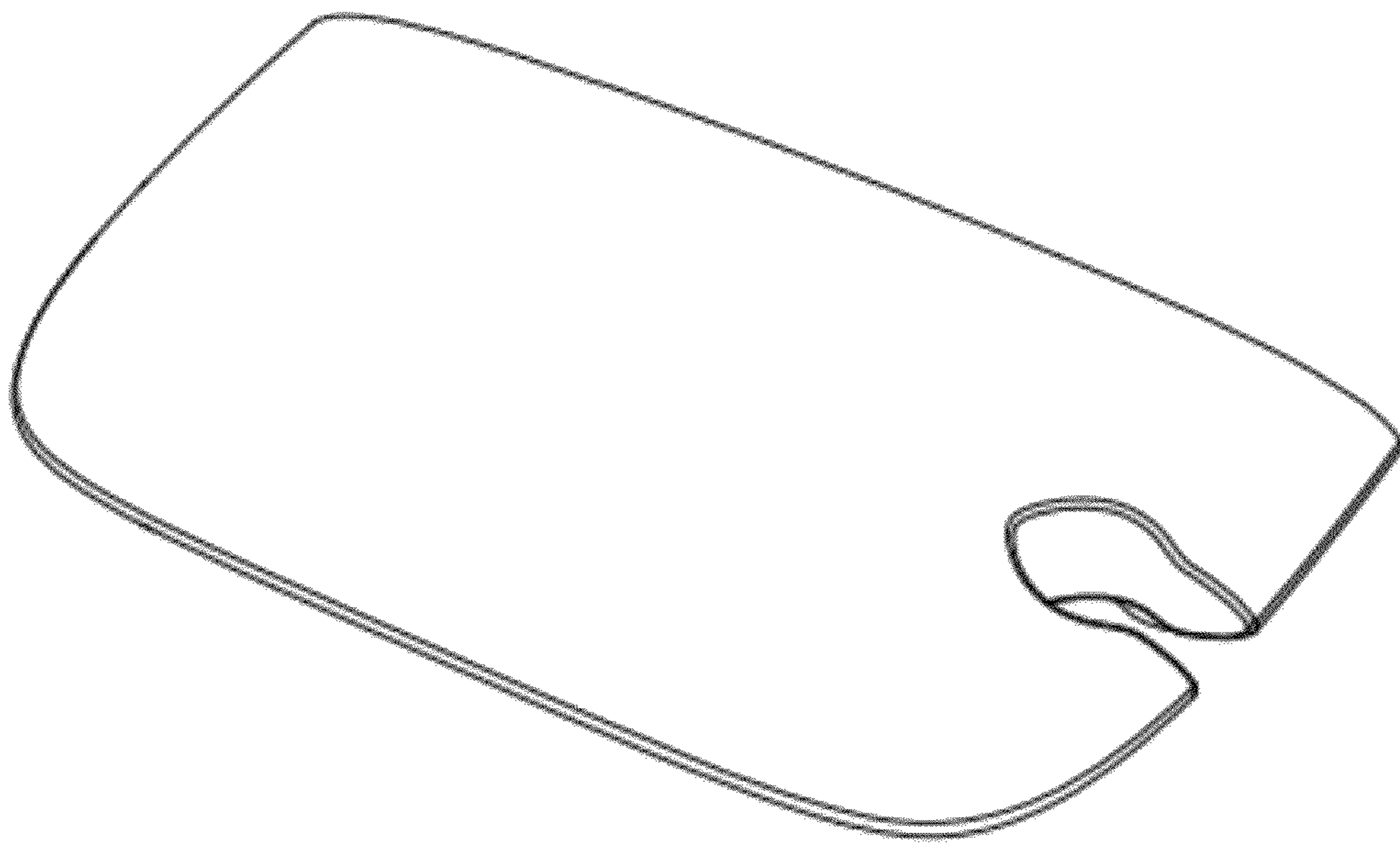

FIG. 1

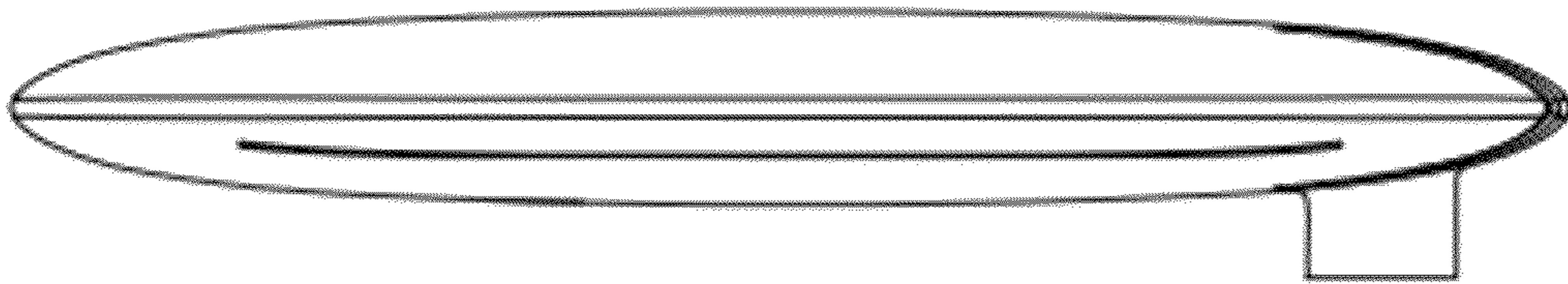

FIG. 2

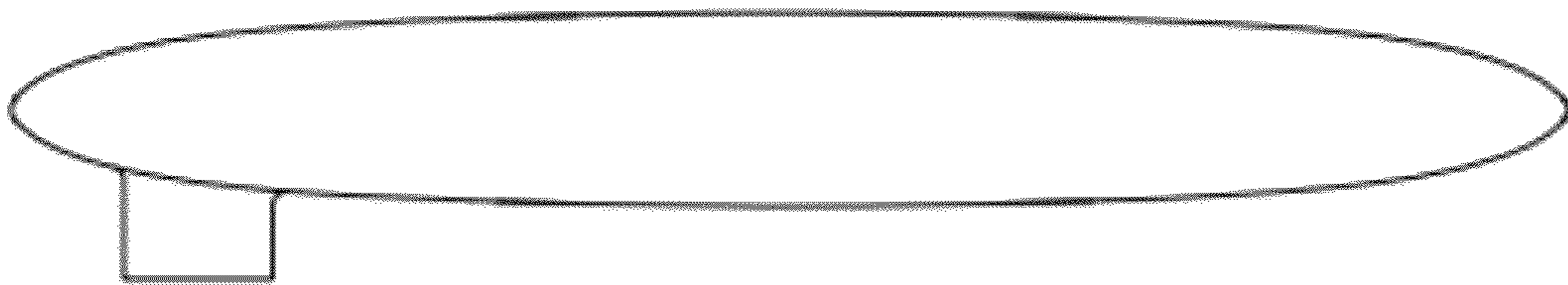

FIG. 3

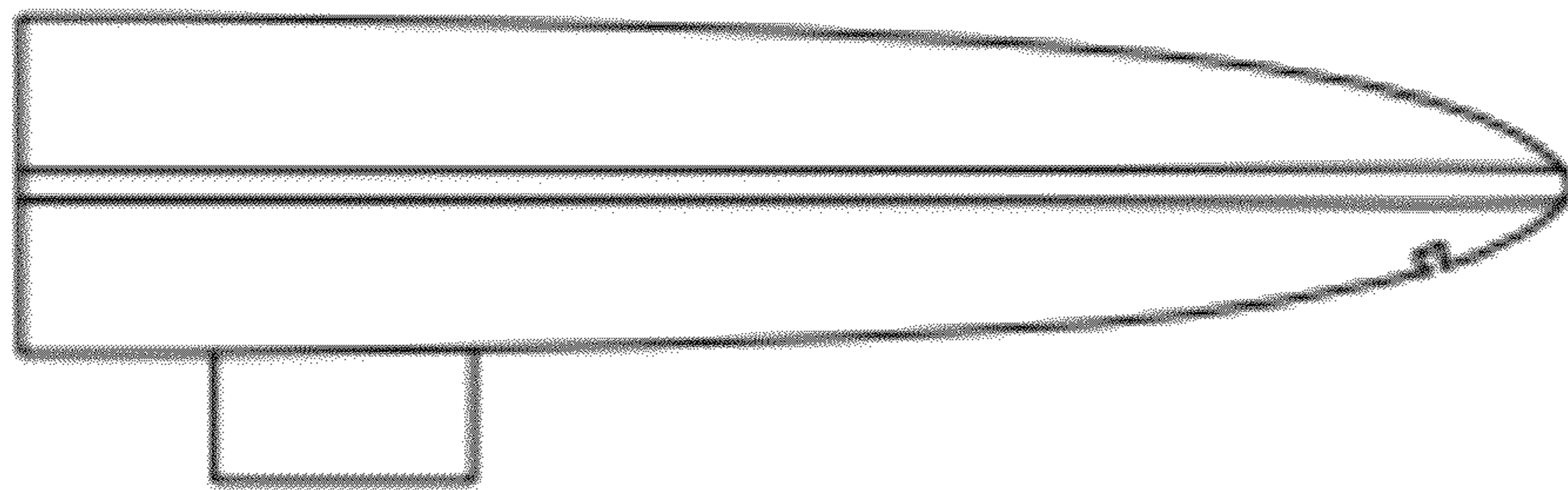

FIG. 4

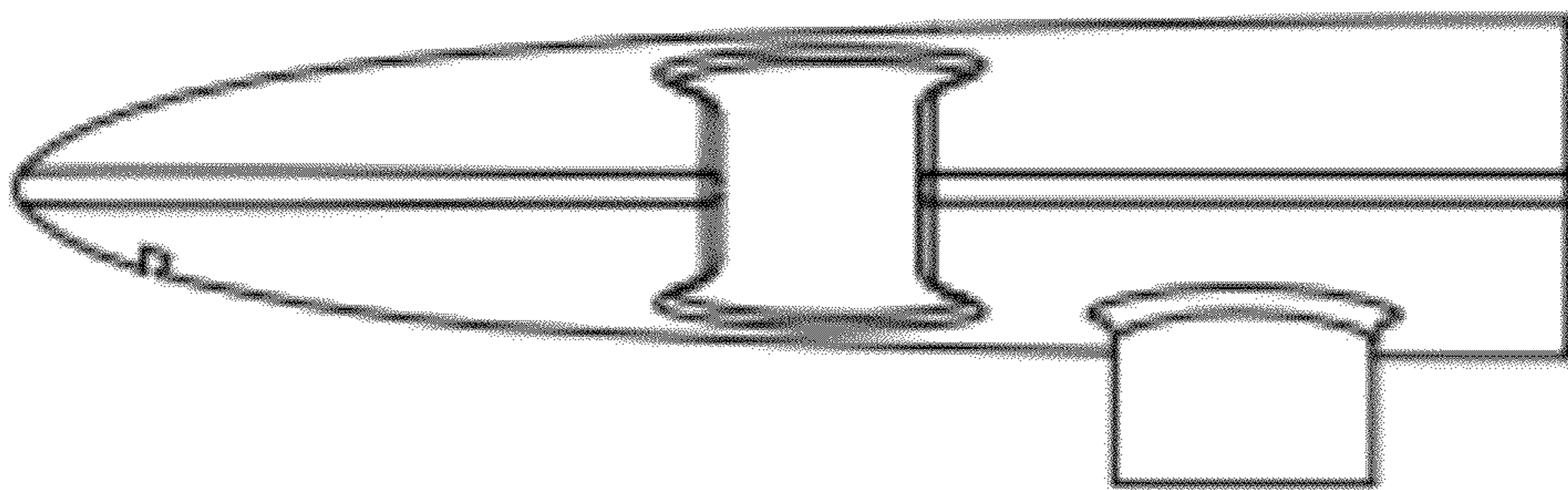

FIG. 5

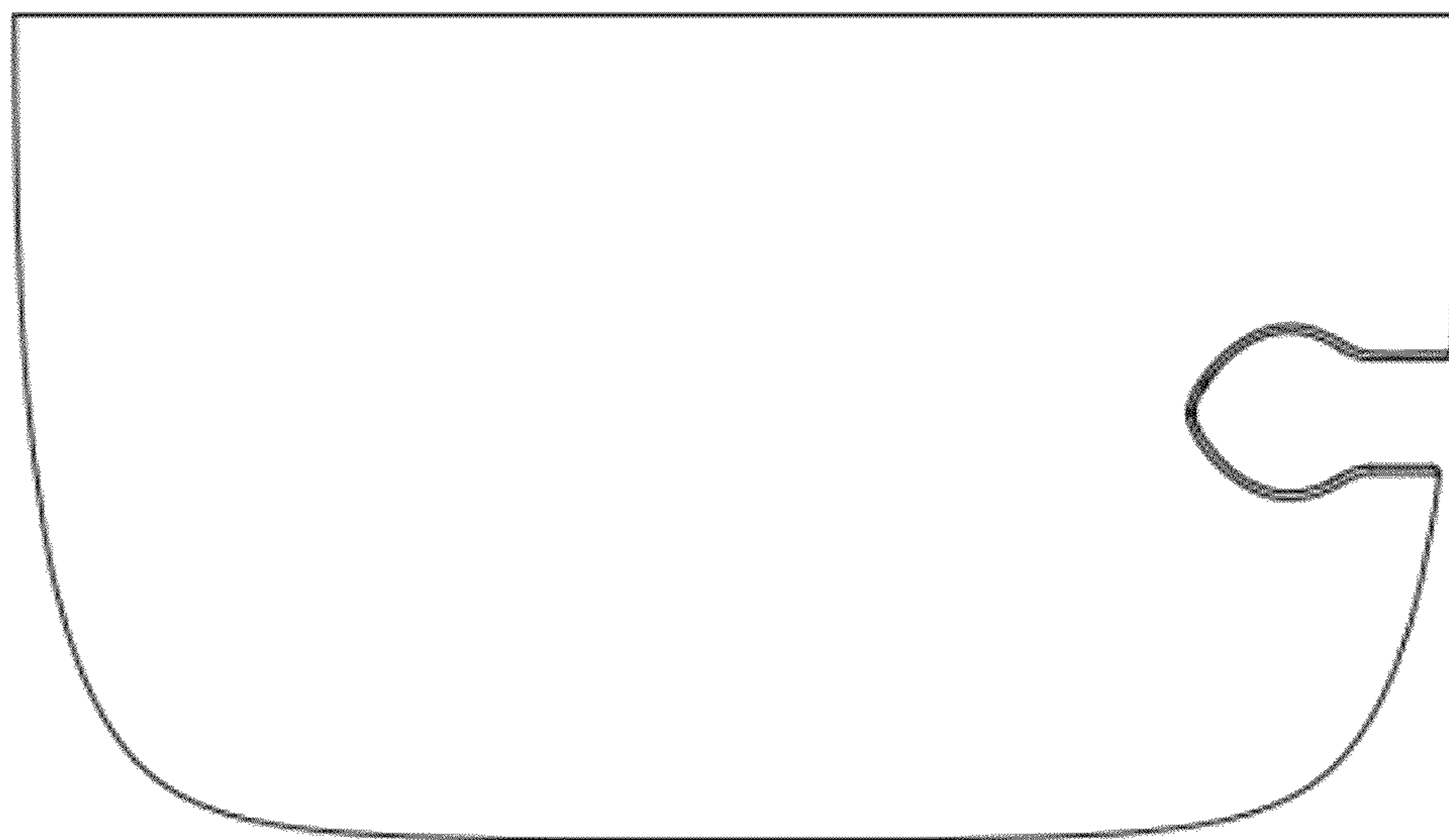

FIG. 6

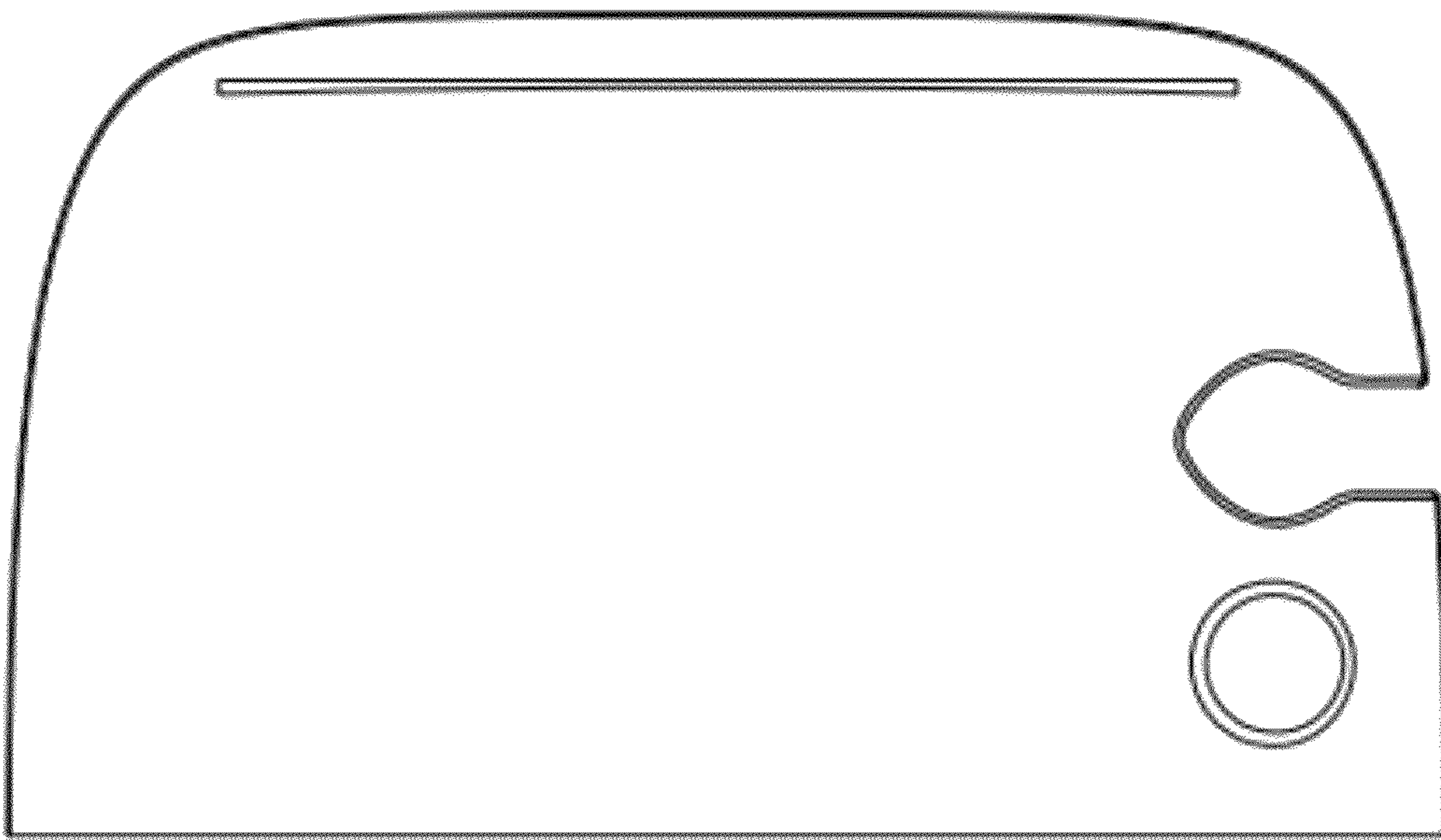

FIG. 7