



US00D663291S

(12) **United States Design Patent**  
**Gondo**

(10) **Patent No.:** **US D663,291 S**  
(45) **Date of Patent:** **\*\* Jul. 10, 2012**

(54) **EARPHONE**

(75) Inventor: **Makoto Gondo**, Kanagawaken (JP)

(73) Assignee: **JVC Kenwood Corporation**, Yokohama (JP)

(\*\*) Term: **14 Years**

(21) Appl. No.: **29/399,477**

(22) Filed: **Aug. 15, 2011**

(30) **Foreign Application Priority Data**

Feb. 16, 2011 (JP) ..... D2011-003237

(51) **LOC (9) Cl.** ..... **14-01**

(52) **U.S. Cl.** ..... **D14/223**

(58) **Field of Classification Search** ..... D14/205,  
D14/206, 223; 181/129, 130, 135; 379/430,  
379/431; 381/380, 381, 322; 455/90.3, 575.1  
See application file for complete search history.

(56) **References Cited**

**U.S. PATENT DOCUMENTS**

D431,553 S *	10/2000	Suzuki	.....	D14/223
D487,077 S *	2/2004	Obata	.....	D14/223
D572,703 S *	7/2008	Ledbetter et al.	.....	D14/205
D591,721 S *	5/2009	Densho	.....	D14/205
D602,905 S *	10/2009	Morisawa	.....	D14/205
D616,874 S *	6/2010	Matsuoka	.....	D14/223

D621,389 S *	8/2010	Nagayama et al.	.....	D14/223
D623,630 S *	9/2010	Ohori et al.	.....	D14/223
D626,948 S *	11/2010	Nault	.....	D14/223
D628,193 S *	11/2010	Zheng	.....	D14/223
D635,558 S *	4/2011	Zheng	.....	D14/223
D641,011 S *	7/2011	Gondo	.....	D14/223
D647,081 S *	10/2011	Kwon	.....	D14/223
D648,708 S *	11/2011	Katsuraku et al.	.....	D14/223

\* cited by examiner

*Primary Examiner* — Paula Greene

(74) *Attorney, Agent, or Firm* — The Nath Law Group;  
Jerald L. Meyer; Robert T. Burns

(57) **CLAIM**

The ornamental design for an earphone, as shown and described.

**DESCRIPTION**

FIG. 1 is a first perspective view of an earphone;  
FIG. 2 is a second perspective view thereof;  
FIG. 3 is a front view thereof;  
FIG. 4 is a rear view thereof;  
FIG. 5 is a right side view thereof;  
FIG. 6 is a left side view thereof;  
FIG. 7 is a top plan view thereof,  
FIG. 8 is a bottom plan view thereof; and,  
FIG. 9 is a sectional view thereof taken along lines 9-9 in FIG. 3, with the internal system omitted.

The broken lines showing on the drawing disclosure are for illustrative purposes only and form no part of the claimed design.

**1 Claim, 7 Drawing Sheets**

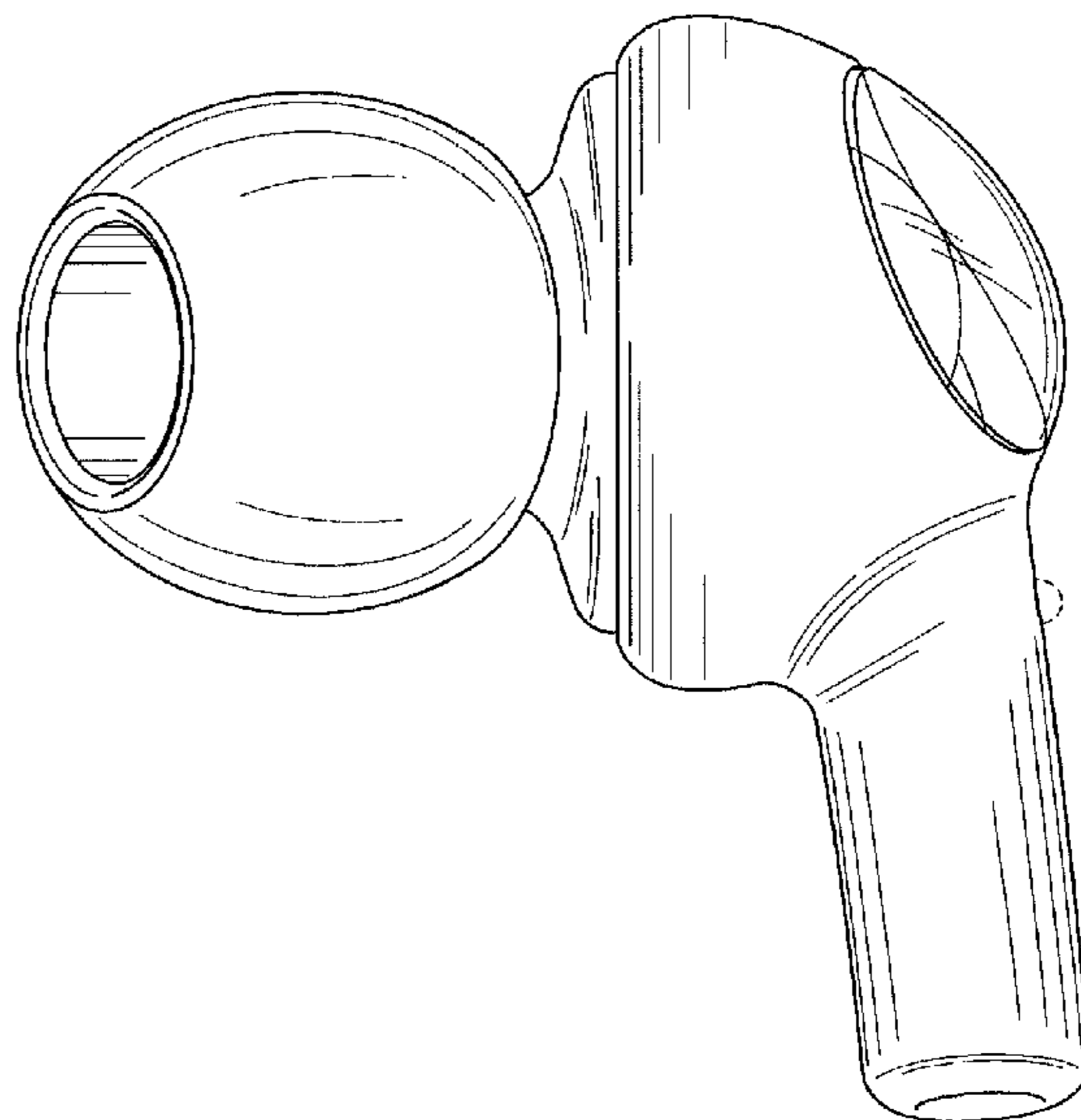
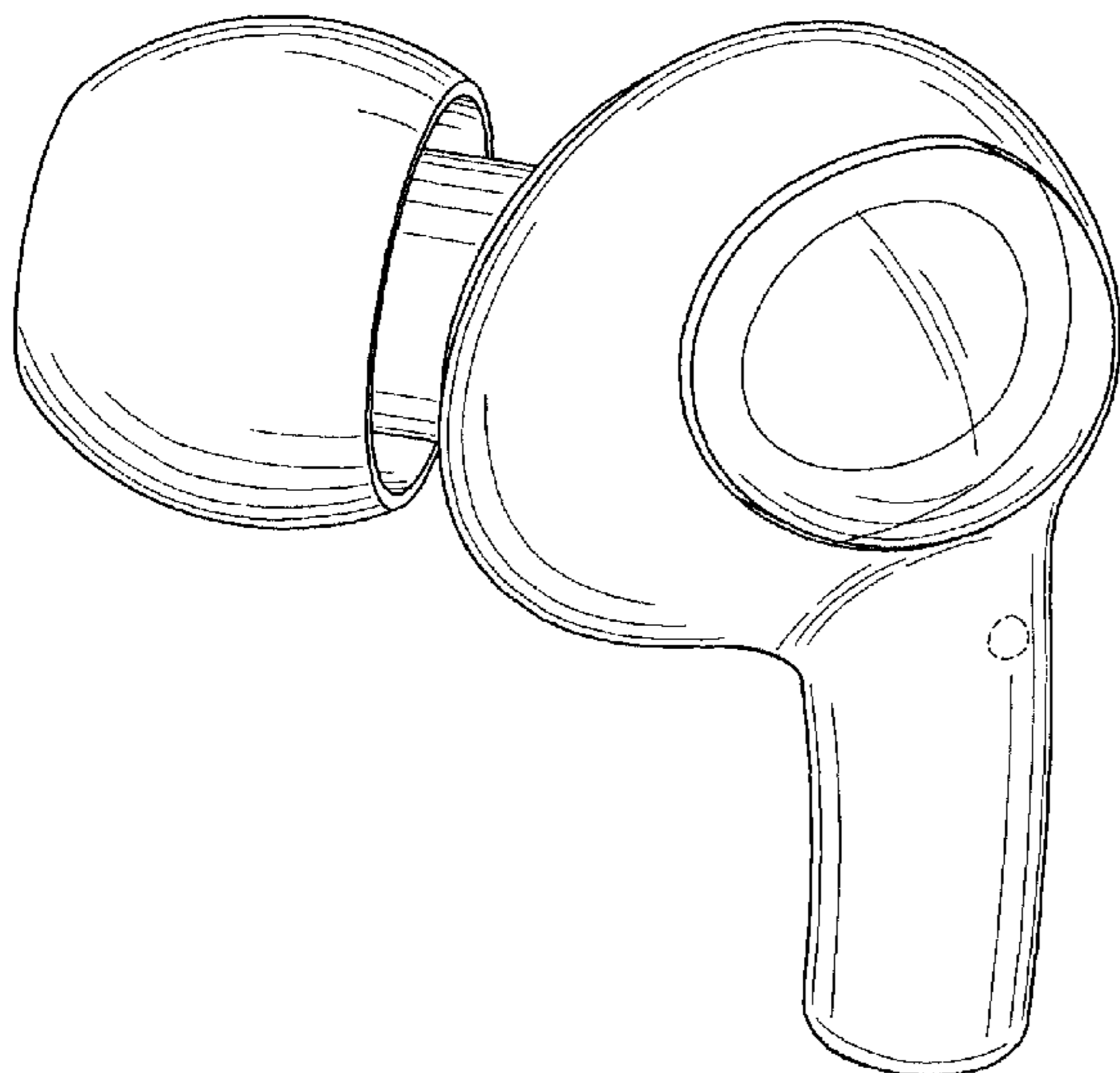

Fig. 1

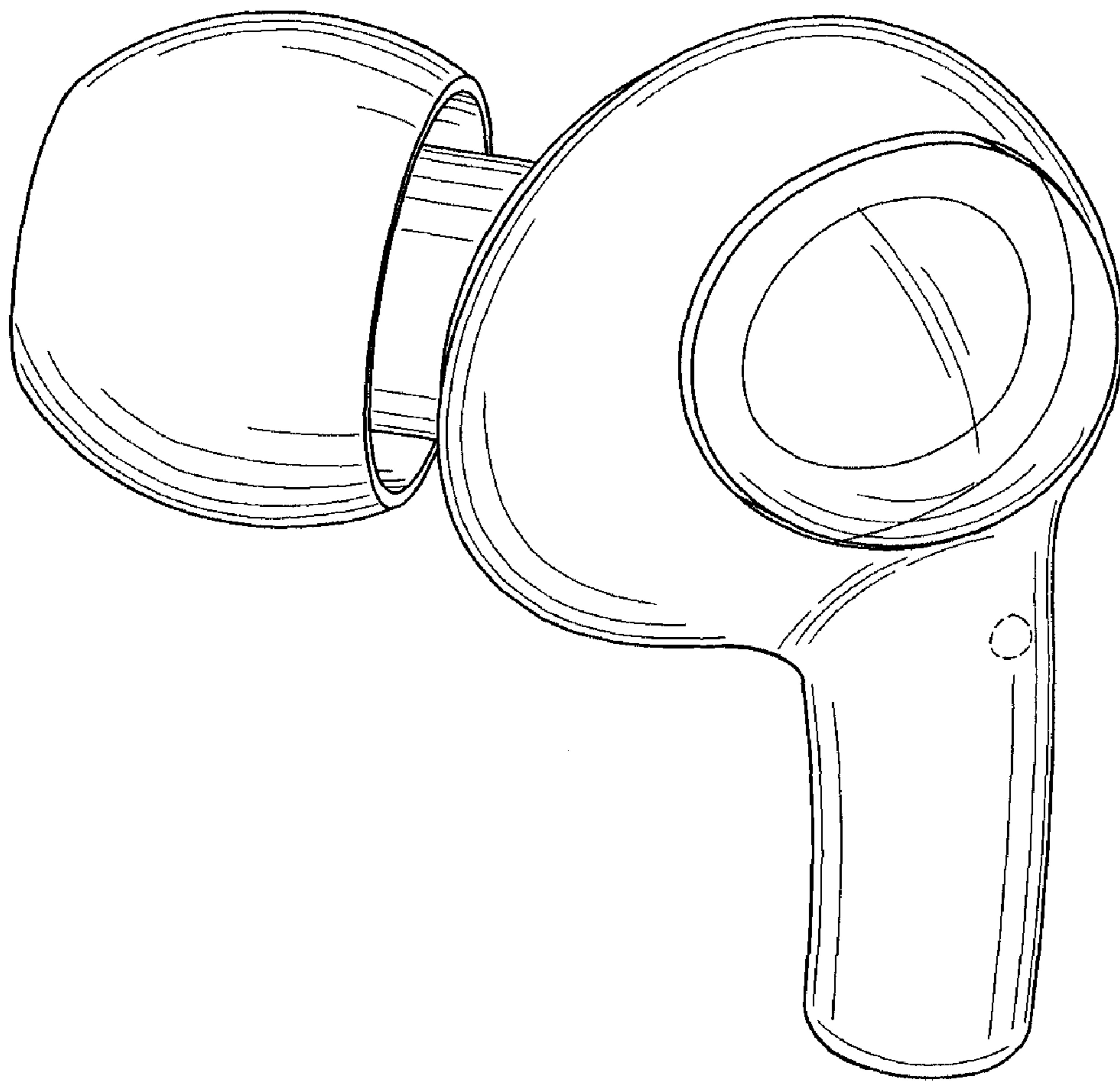

Fig.2

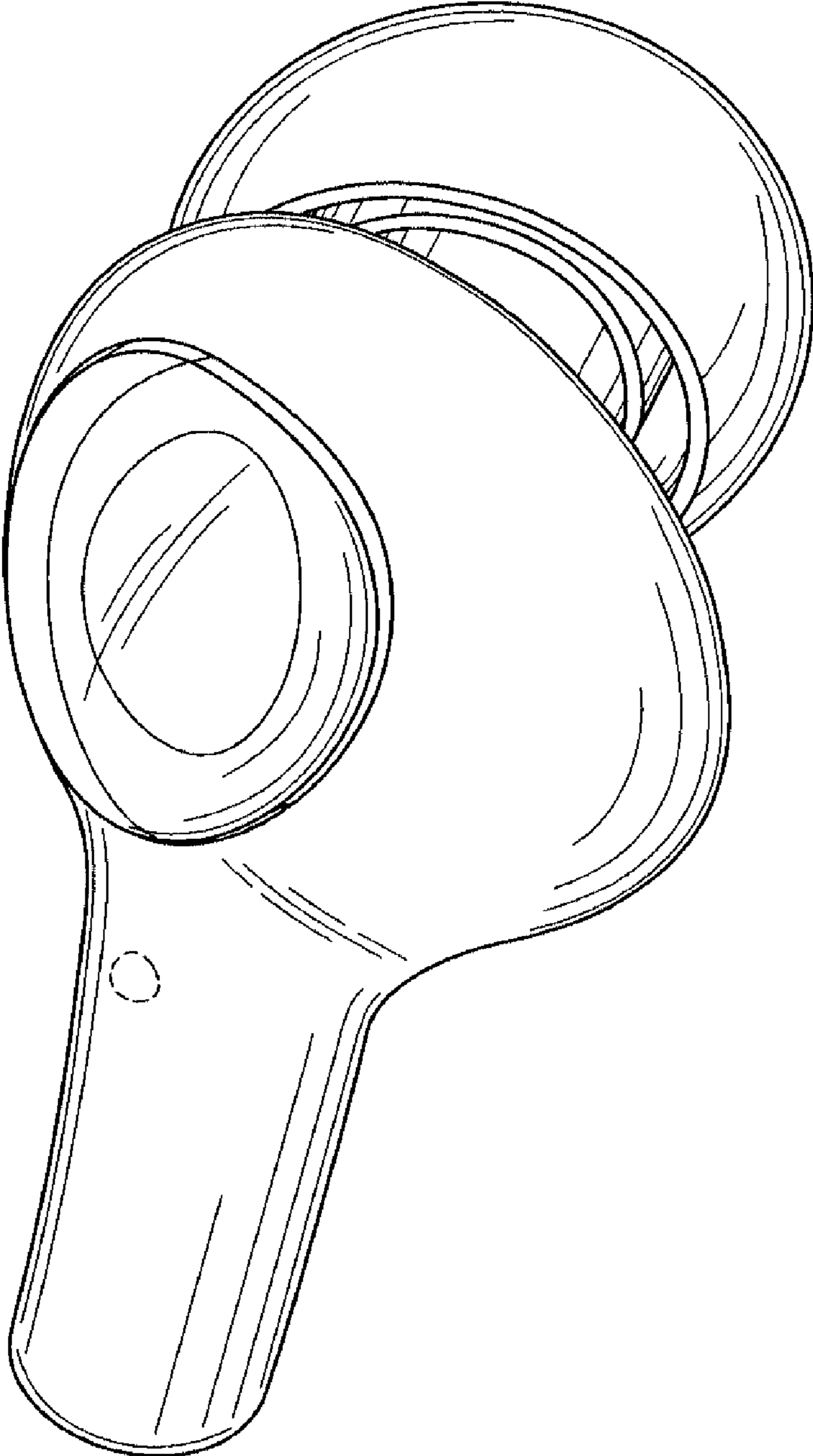

Fig.3

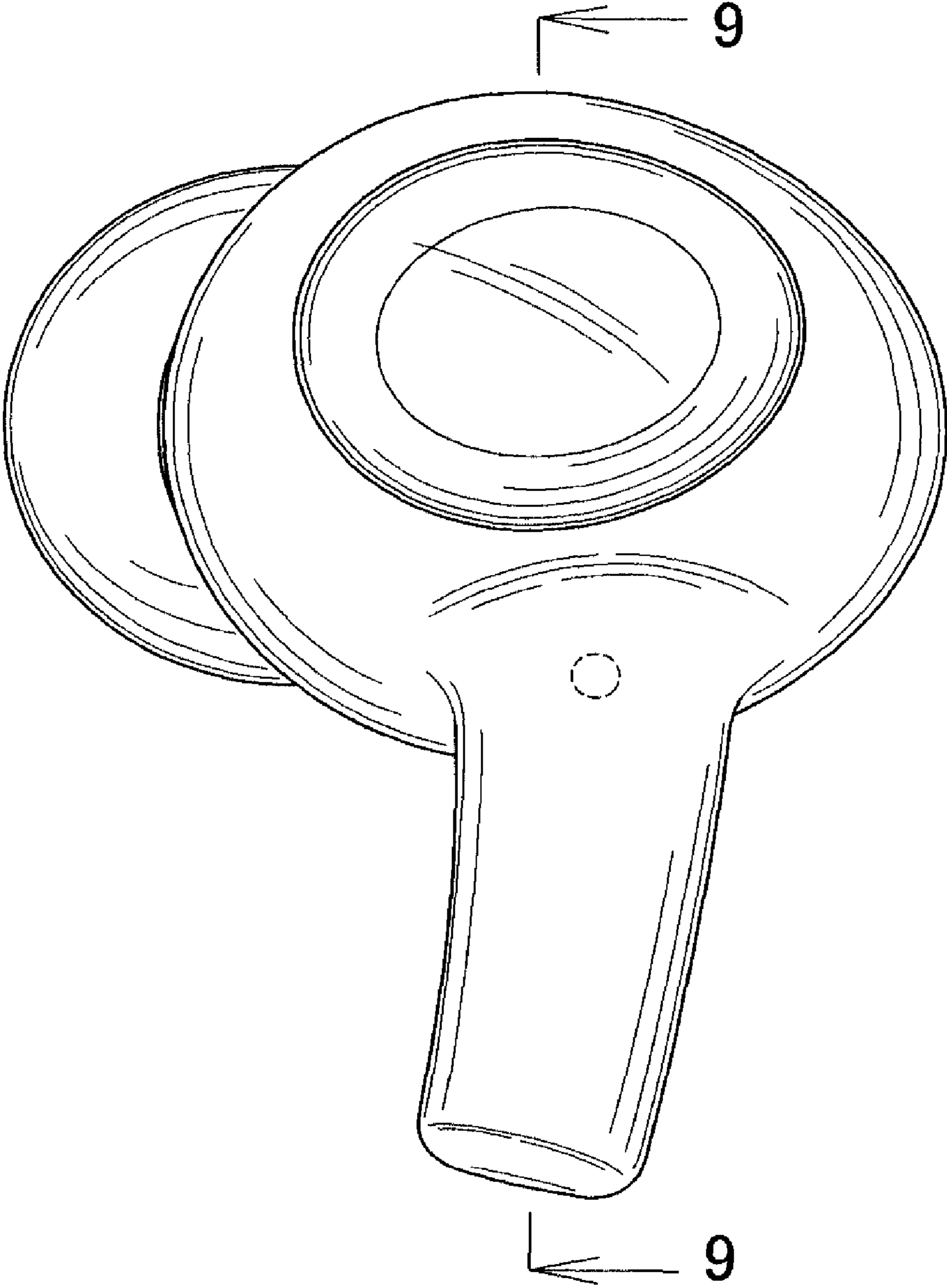

Fig.4

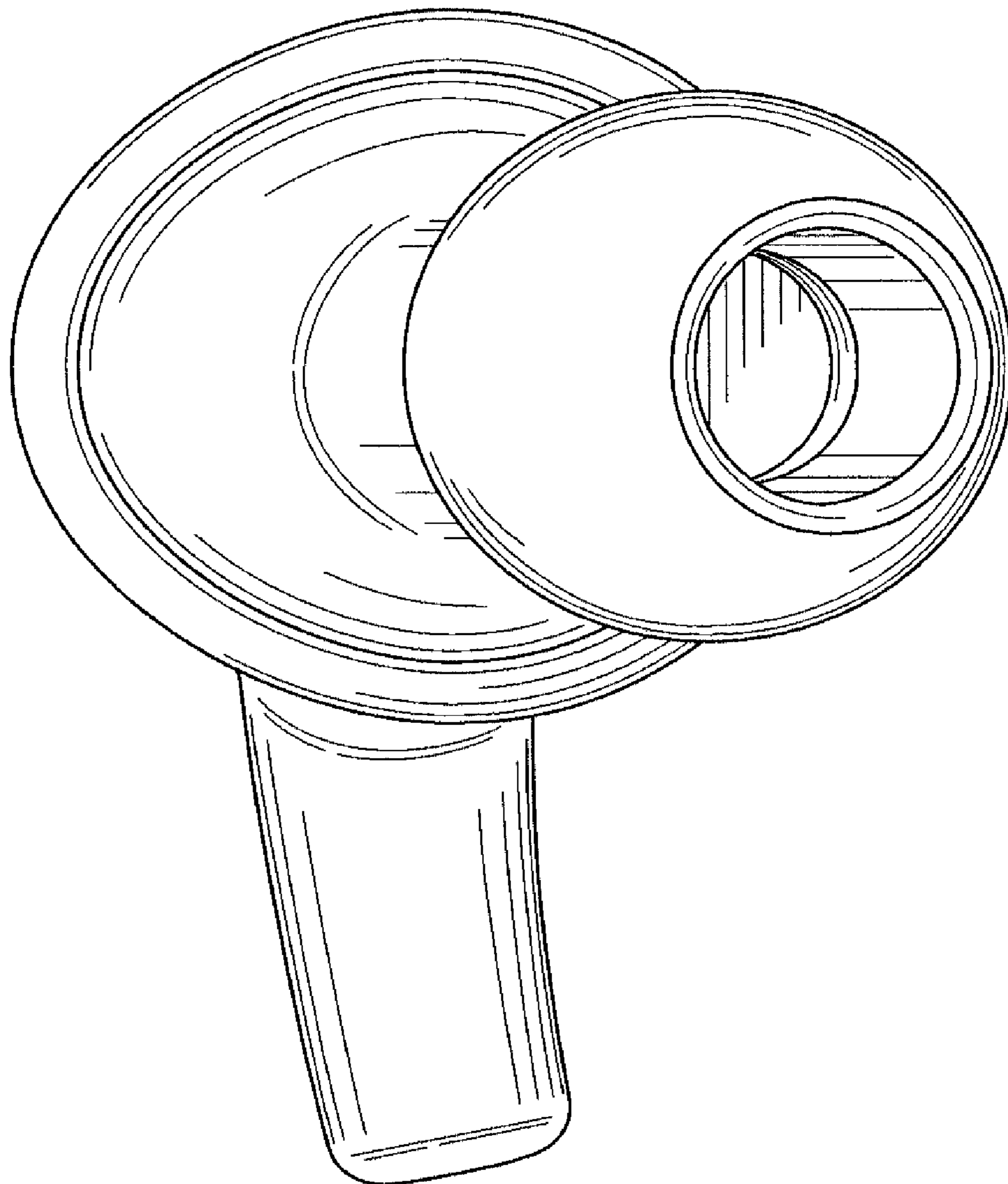

Fig.5

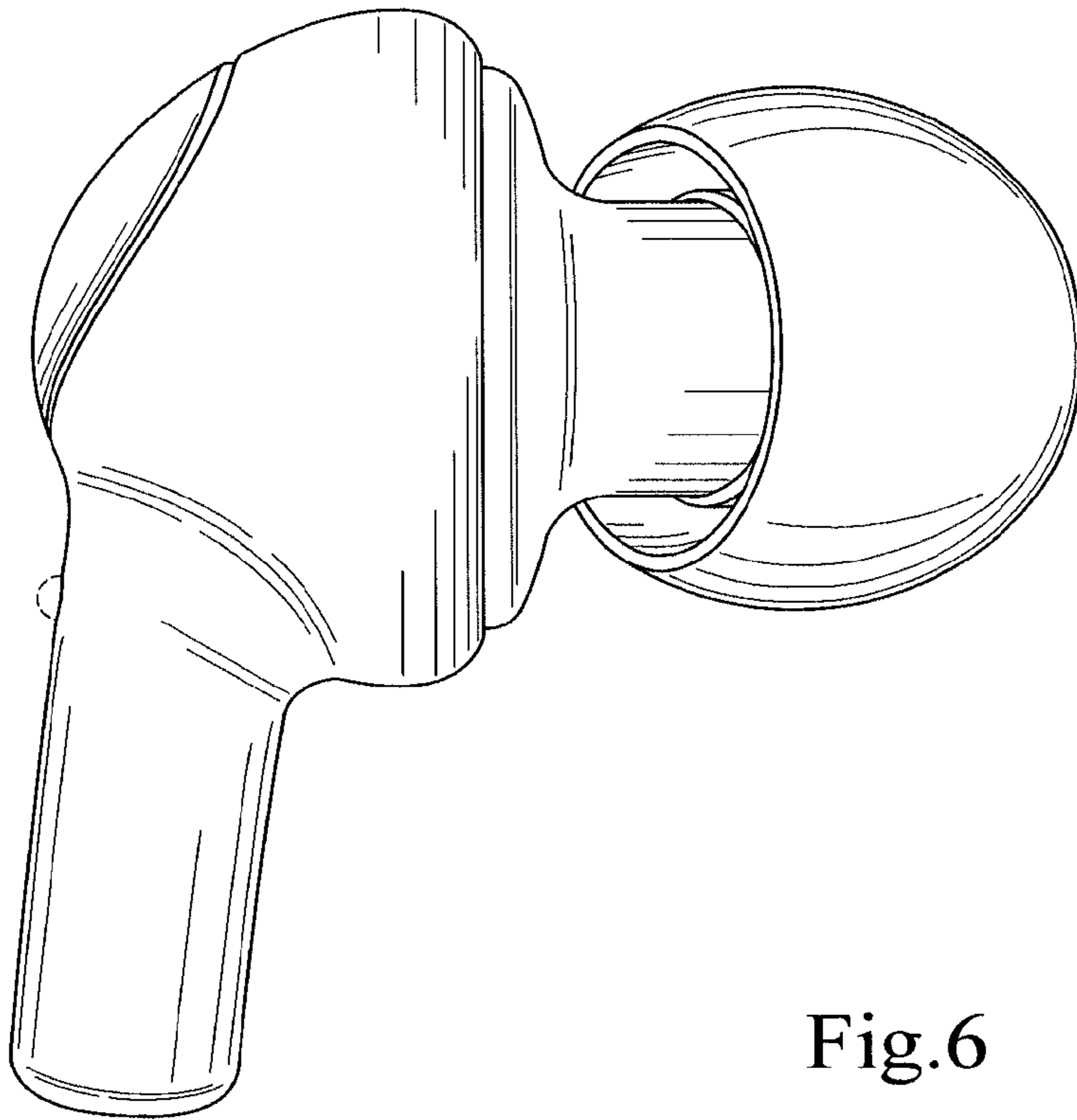

Fig.6

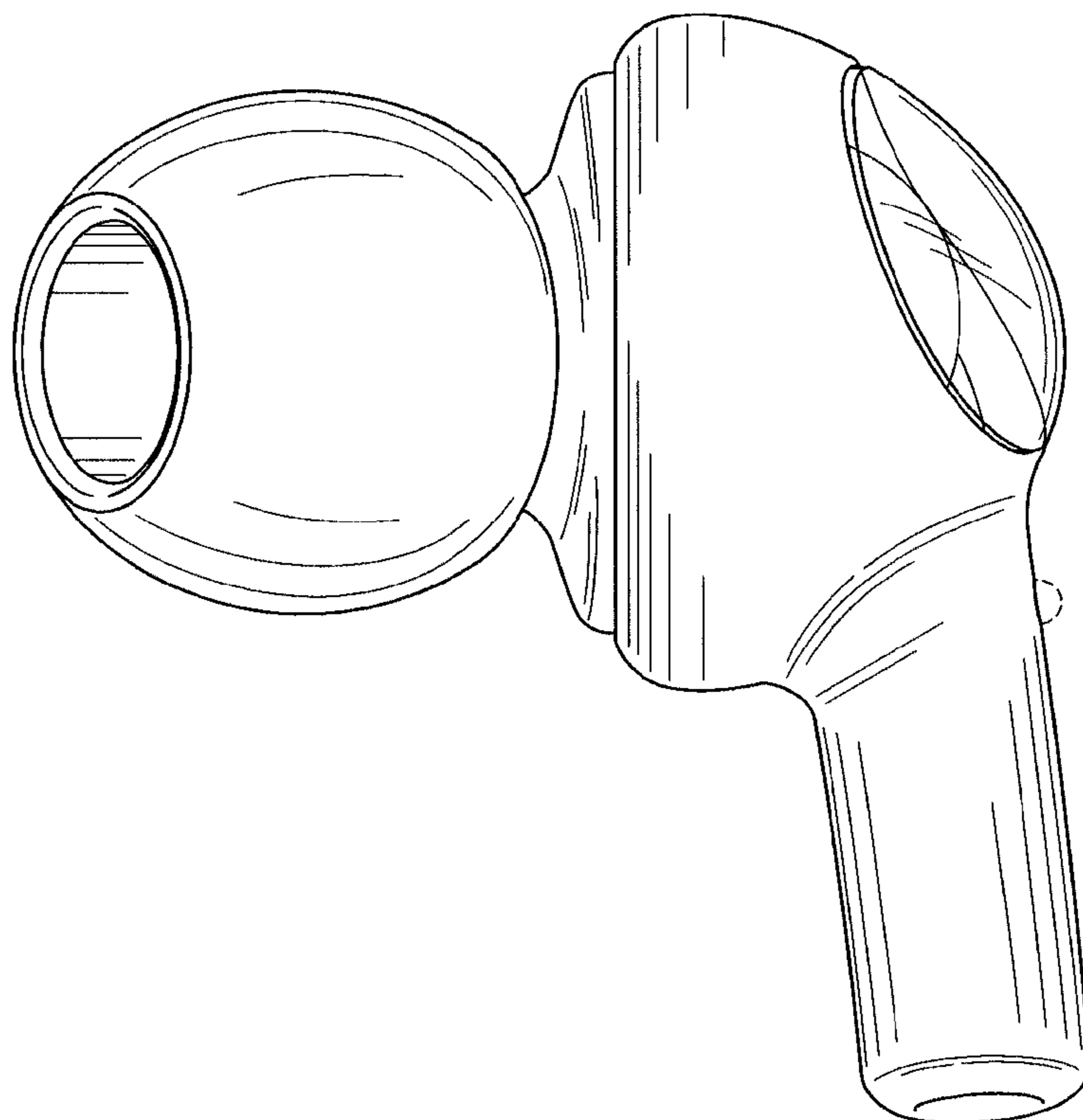

Fig.7

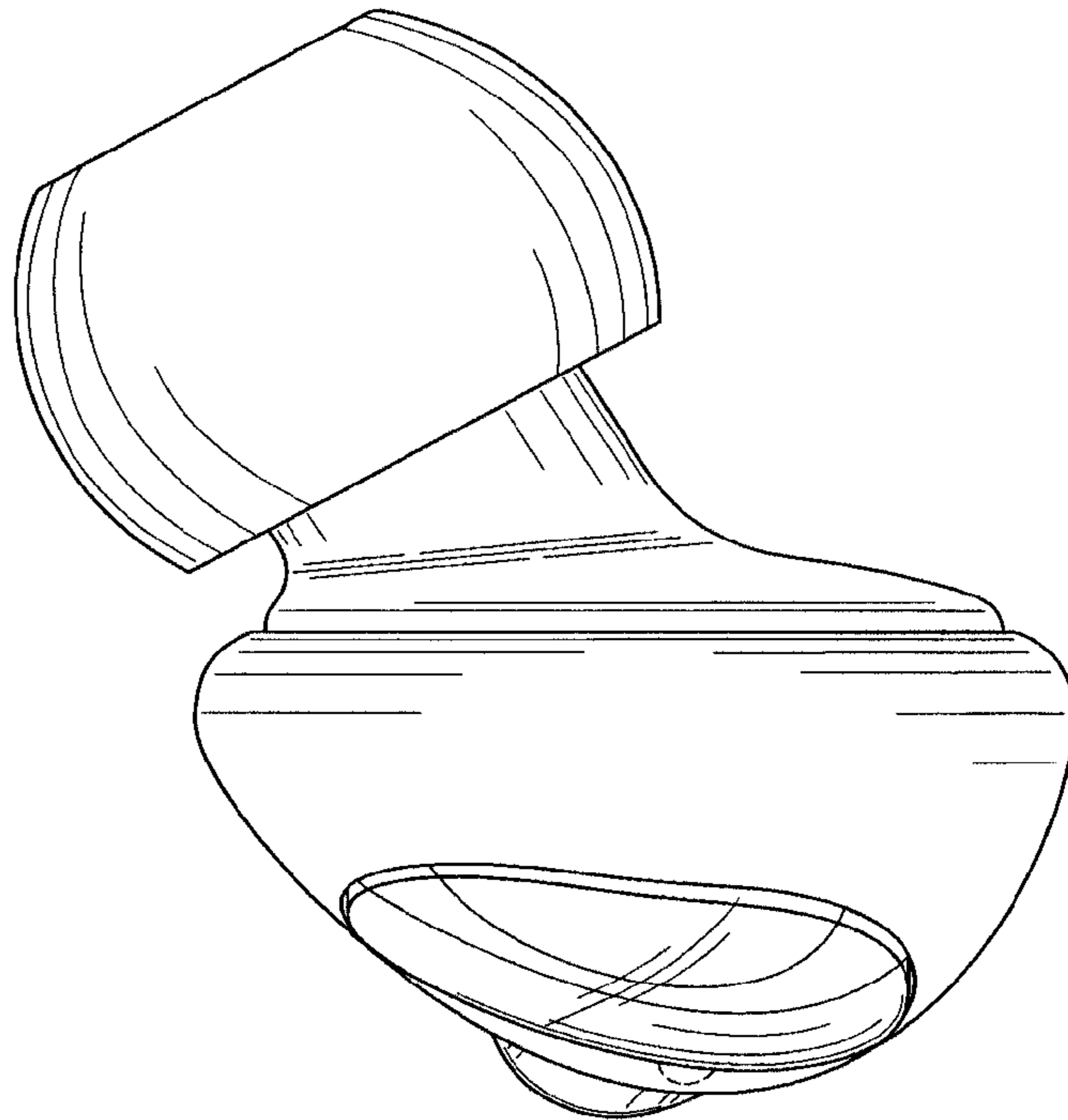

Fig.8

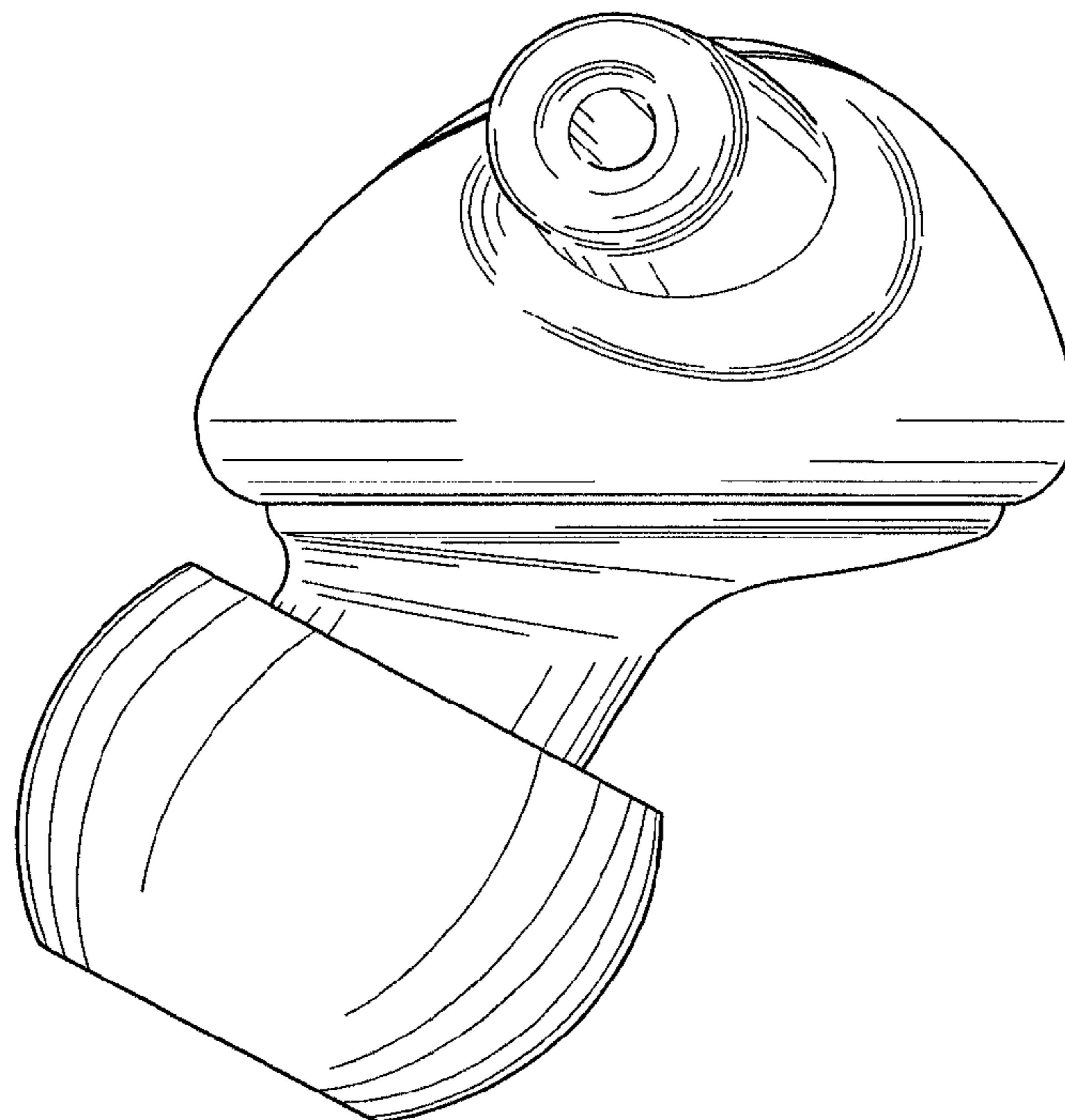

Fig.9

