



US00D663272S

(12) **United States Design Patent**  
**Lyford et al.**

(10) **Patent No.:** **US D663,272 S**  
(45) **Date of Patent:** **\*\* Jul. 10, 2012**

(54) **PLUG FOR ACCESSORY-HOST INTERFACE**

(75) Inventors: **J. Steven Lyford**, Portland, OR (US);  
**Robert R. Kreitzer**, Tigard, OR (US)

(73) Assignee: **Tektronix, Inc.**, Beaverton, OR (US)

(\*\*) Term: **14 Years**

(21) Appl. No.: **29/382,275**

(22) Filed: **Dec. 30, 2010**

(51) **LOC (9) Cl.** ..... **13-03**

(52) **U.S. Cl.** ..... **D13/133**

(58) **Field of Classification Search** ..... D13/133,  
D13/134, 135, 147, 154, 184, 199; D14/217,  
D14/356, 358, 369, 383, 385, 432, 433, 439,  
D14/440, 447, 454; D10/76, 78, 80; 439/180,  
439/246, 252, 278, 374, 378, 379, 380, 381,  
439/527, 529, 530, 533, 892, 894, 630

See application file for complete search history.

(56) **References Cited**

U.S. PATENT DOCUMENTS

D370,889 S *	6/1996	Anthony	.....	D13/146
D460,371 S *	7/2002	Wrisley et al.	.....	D10/78
D514,004 S *	1/2006	Wrisley	.....	D10/76
D556,066 S *	11/2007	Hoang et al.	.....	D10/76
D566,046 S *	4/2008	Gabel et al.	.....	D13/154
D566,047 S *	4/2008	Gabel et al.	.....	D13/154
D643,841 S *	8/2011	Lyford et al.	.....	D14/433
D649,970 S *	12/2011	Lyford et al.	.....	D14/433
D649,971 S *	12/2011	Lyford et al.	.....	D14/433

\* cited by examiner

Primary Examiner — Daniel Bui

(74) Attorney, Agent, or Firm — William K. Bucher

(57) **CLAIM**

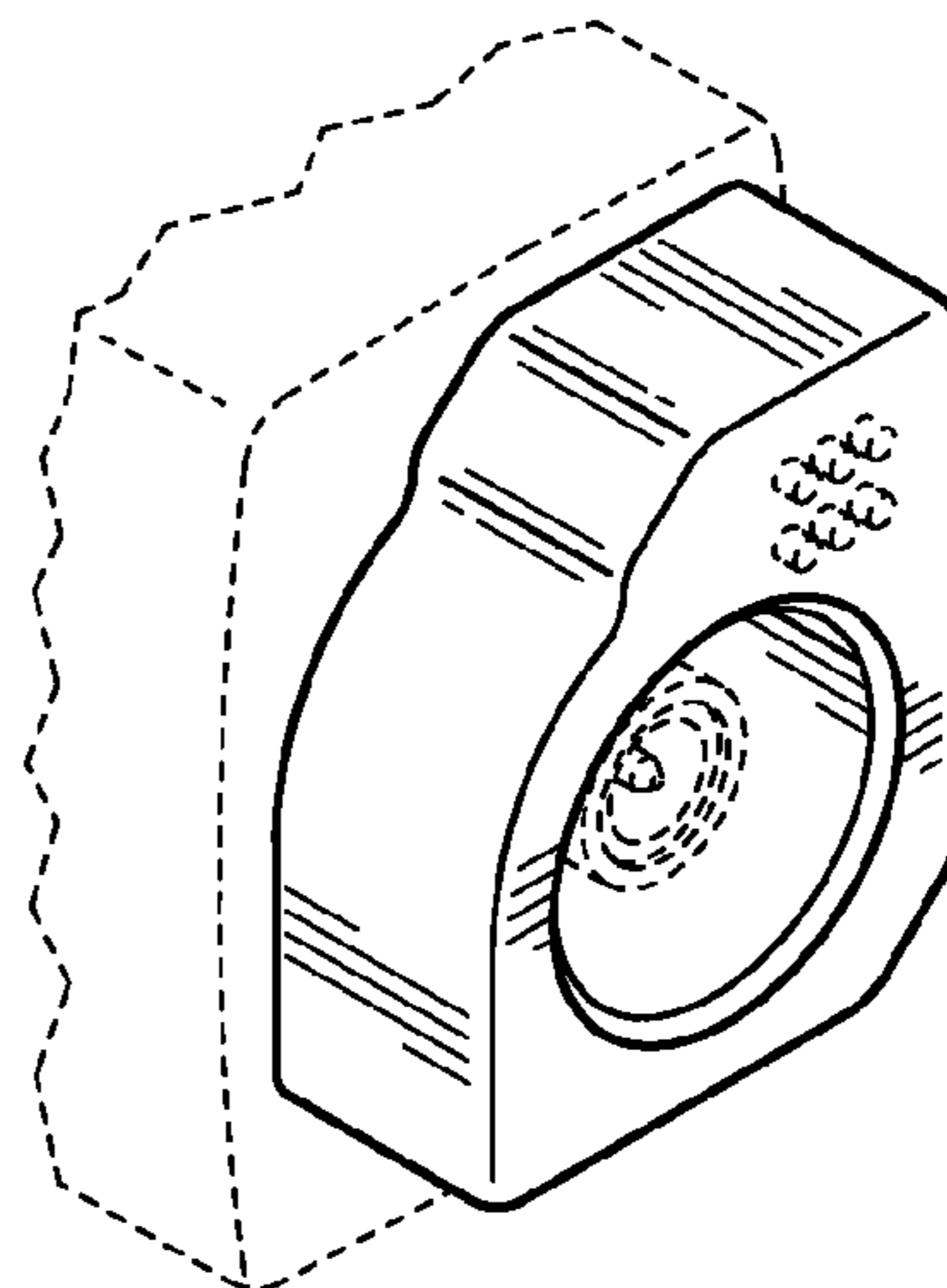
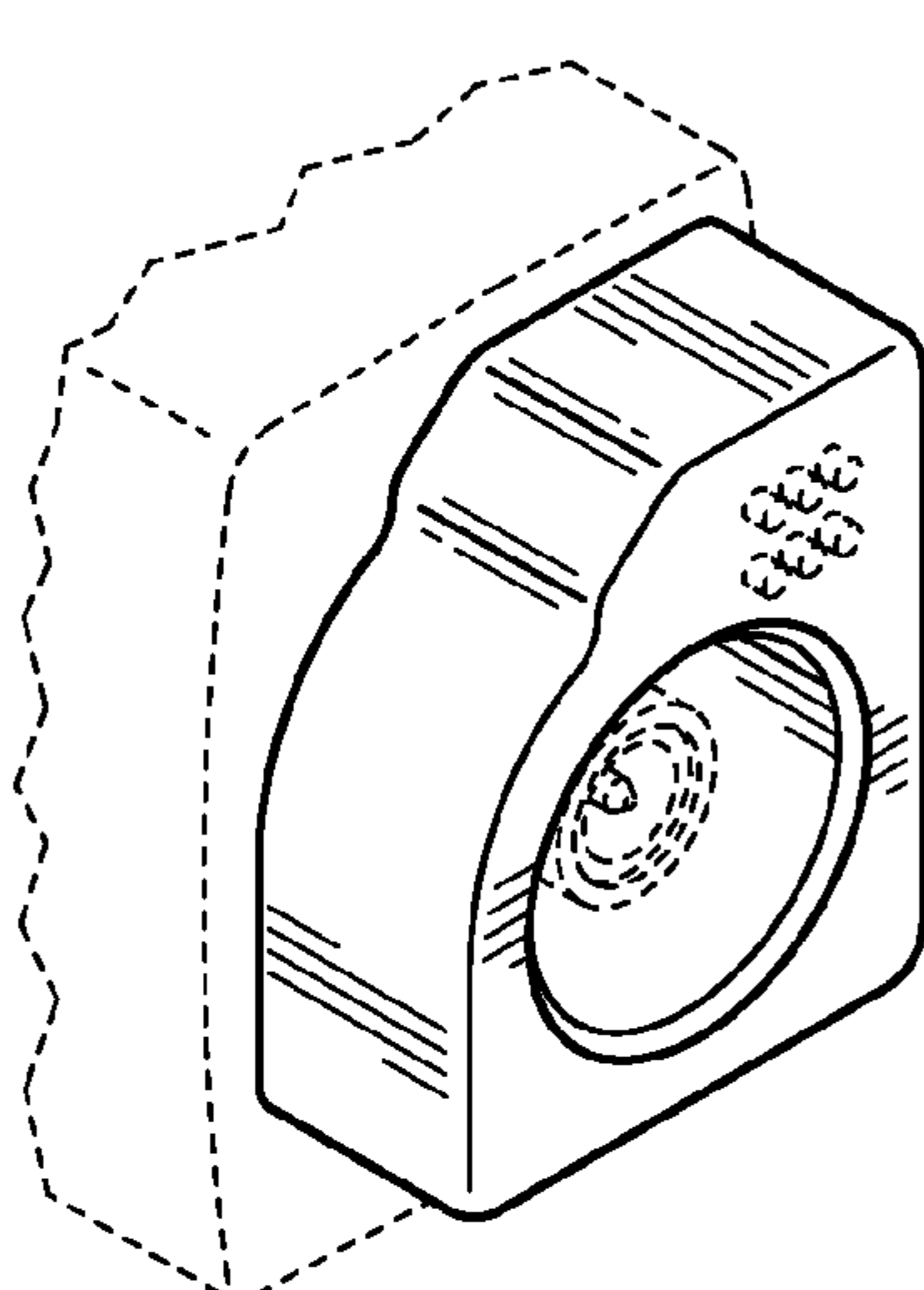
The ornamental design for a plug for accessory-host interface, as shown and described.

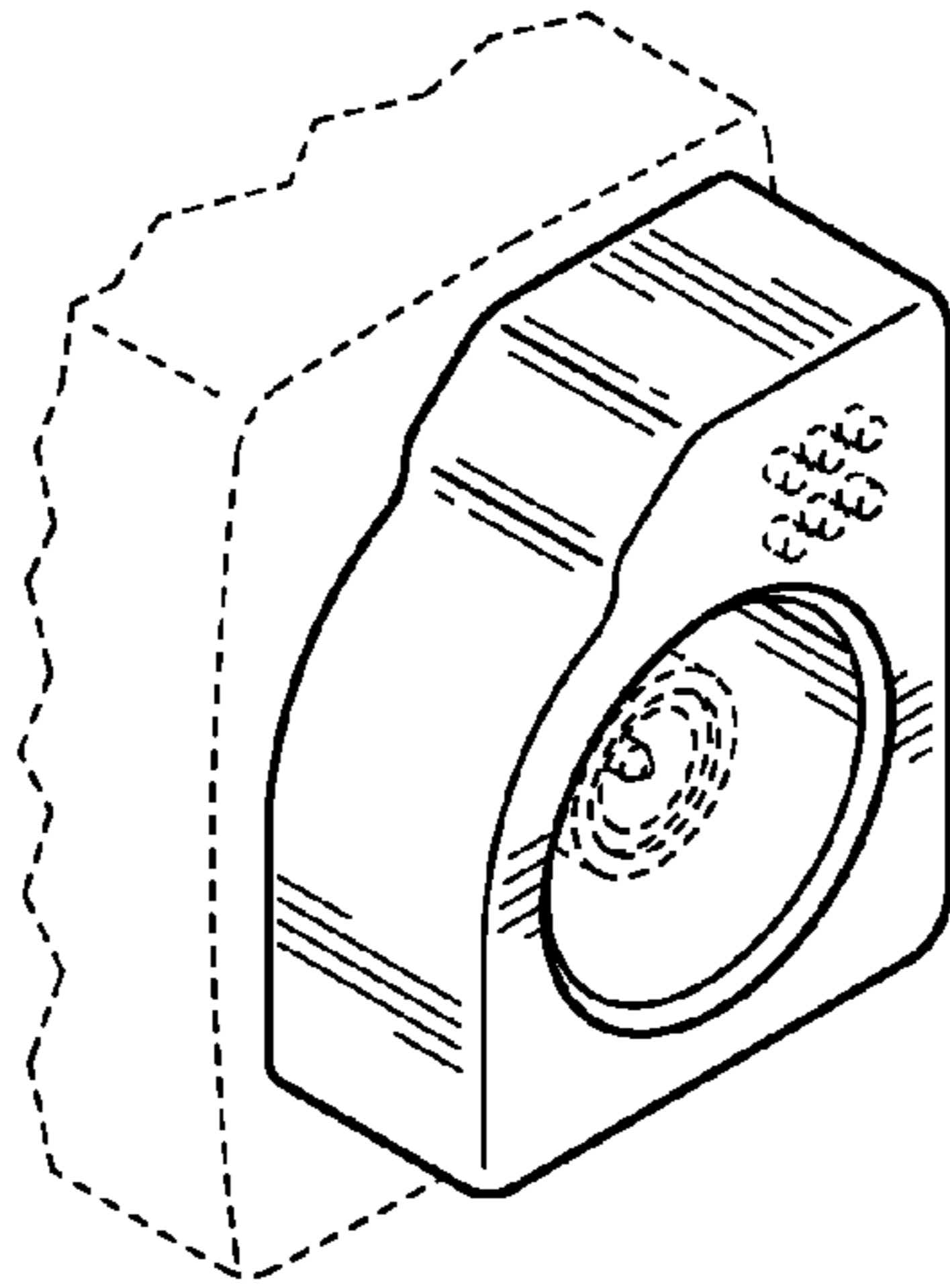
**DESCRIPTION**

FIG. 1 is a front perspective view of a first embodiment of a plug for accessory-host interface showing our new design; FIG. 2 is a front elevation view thereof; FIG. 3 is a left side elevation view thereof; FIG. 4 is a right side elevation view; FIG. 5 is a top plan view thereof; FIG. 6 is a bottom plan view thereof; FIG. 7 is a front perspective view of a second embodiment of a plug for accessory-host interface showing our new design; FIG. 8 is a front elevation view thereof; FIG. 9 is a left side elevation view thereof; FIG. 10 is a right side elevation view; FIG. 11 is a top plan view thereof; FIG. 12 is a bottom plan view thereof; FIG. 13 is a front perspective view of a third embodiment of a plug for accessory-host interface showing our new design; FIG. 14 is a front elevation view thereof; FIG. 15 is a left side elevation view thereof; FIG. 16 is a right side elevation view; FIG. 17 is a top plan view thereof; FIG. 18 is a bottom plan view thereof; FIG. 19 is a front perspective view of a fourth embodiment of a plug for accessory-host interface showing our new design; FIG. 20 is a front elevation view thereof; FIG. 21 is a left side elevation view thereof; FIG. 22 is a right side elevation view; FIG. 23 is a top plan view thereof; and, FIG. 24 is a bottom plan view thereof.

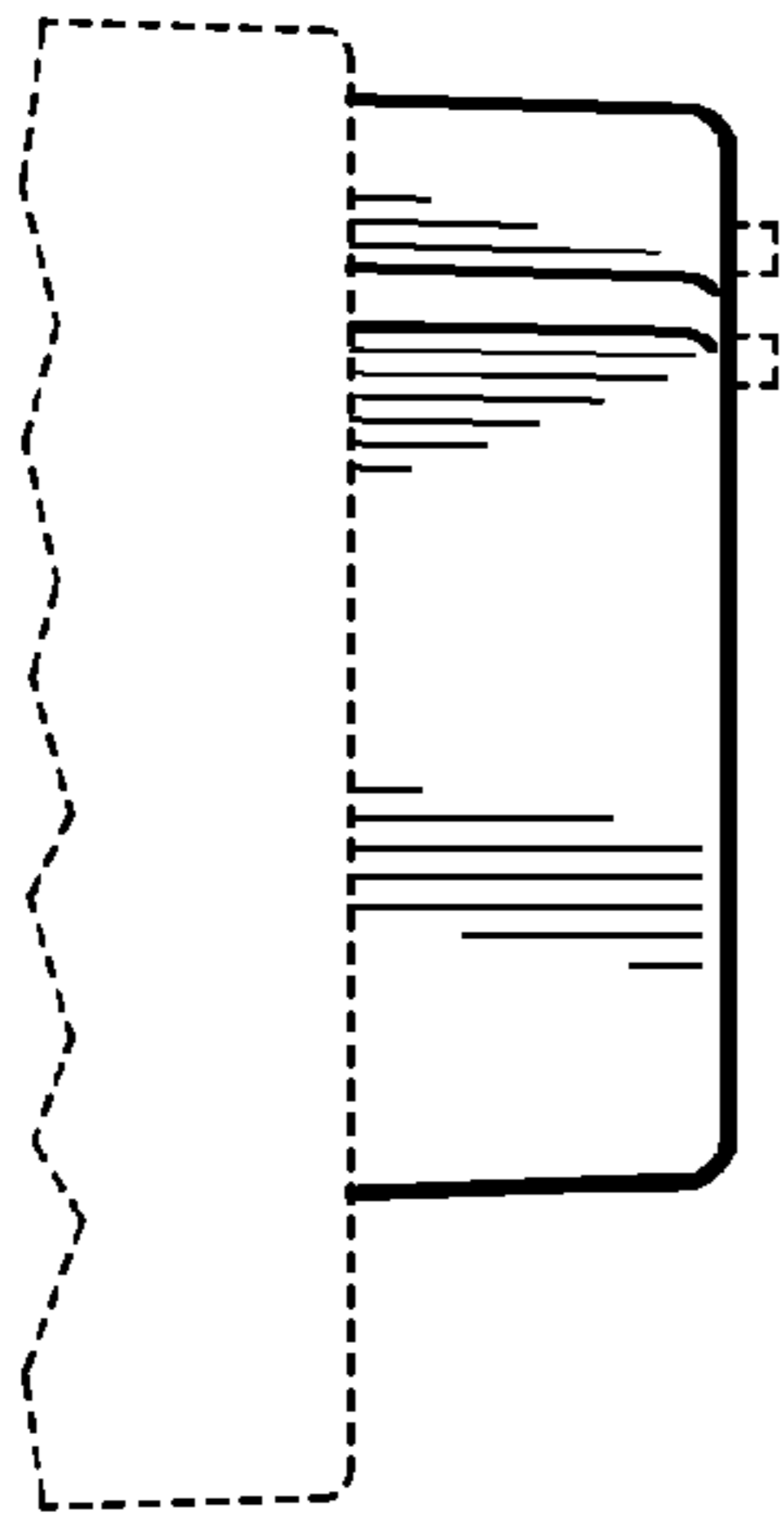
The broken line portion of the figure drawings is included for the purpose of illustrating environment and forms no part of the claimed design.

**1 Claim, 4 Drawing Sheets**

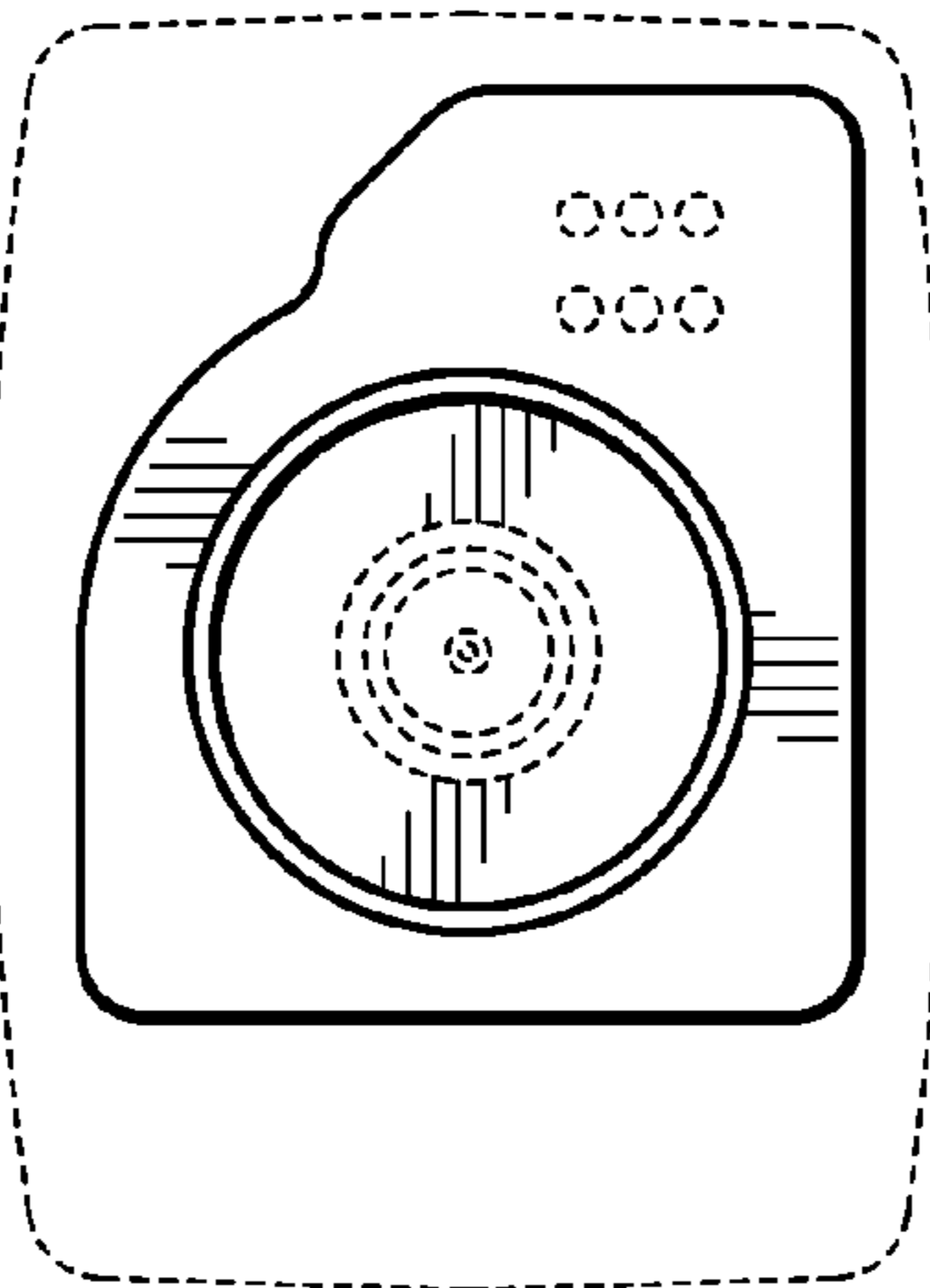




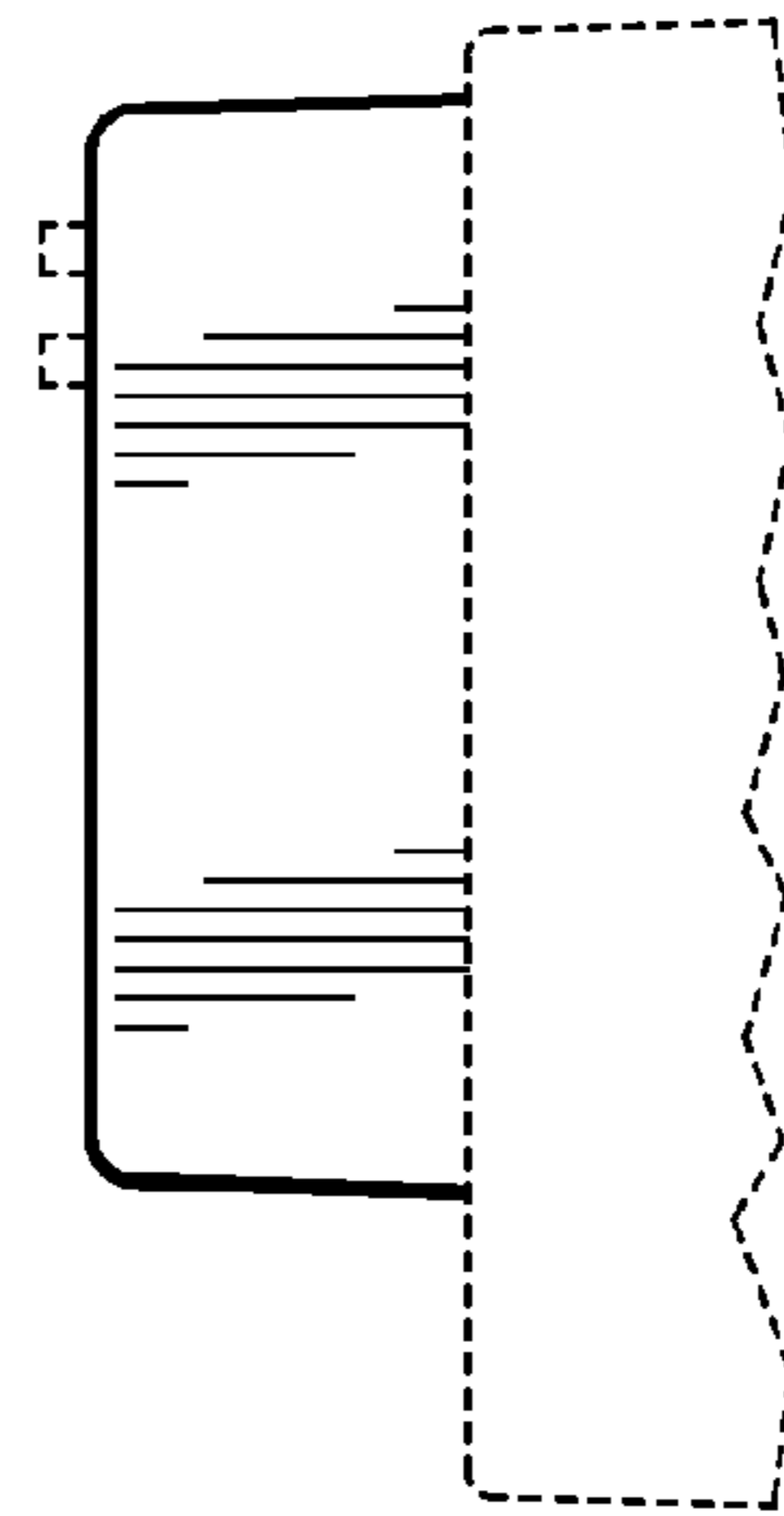
**Figure 1**



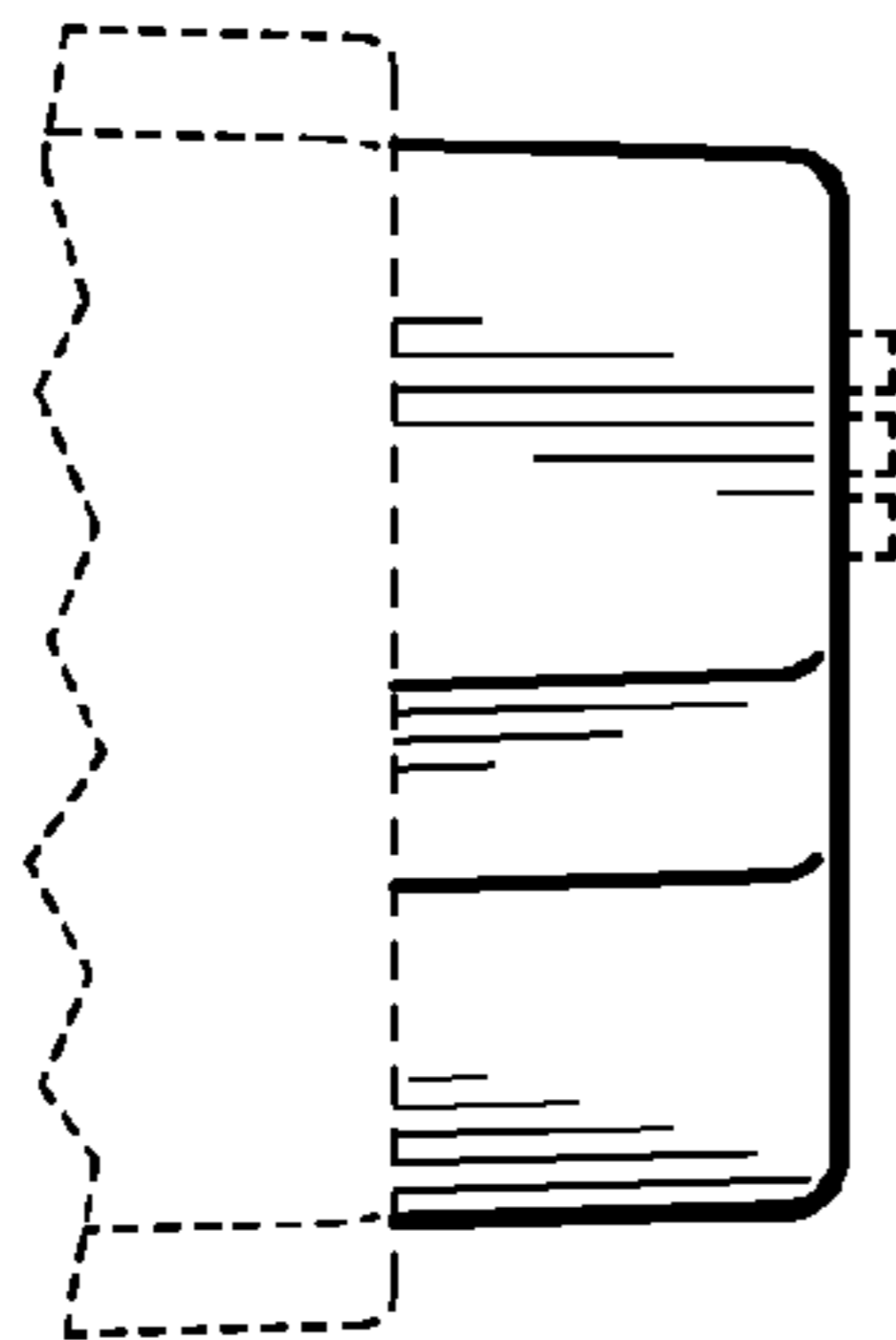
**Figure 3**



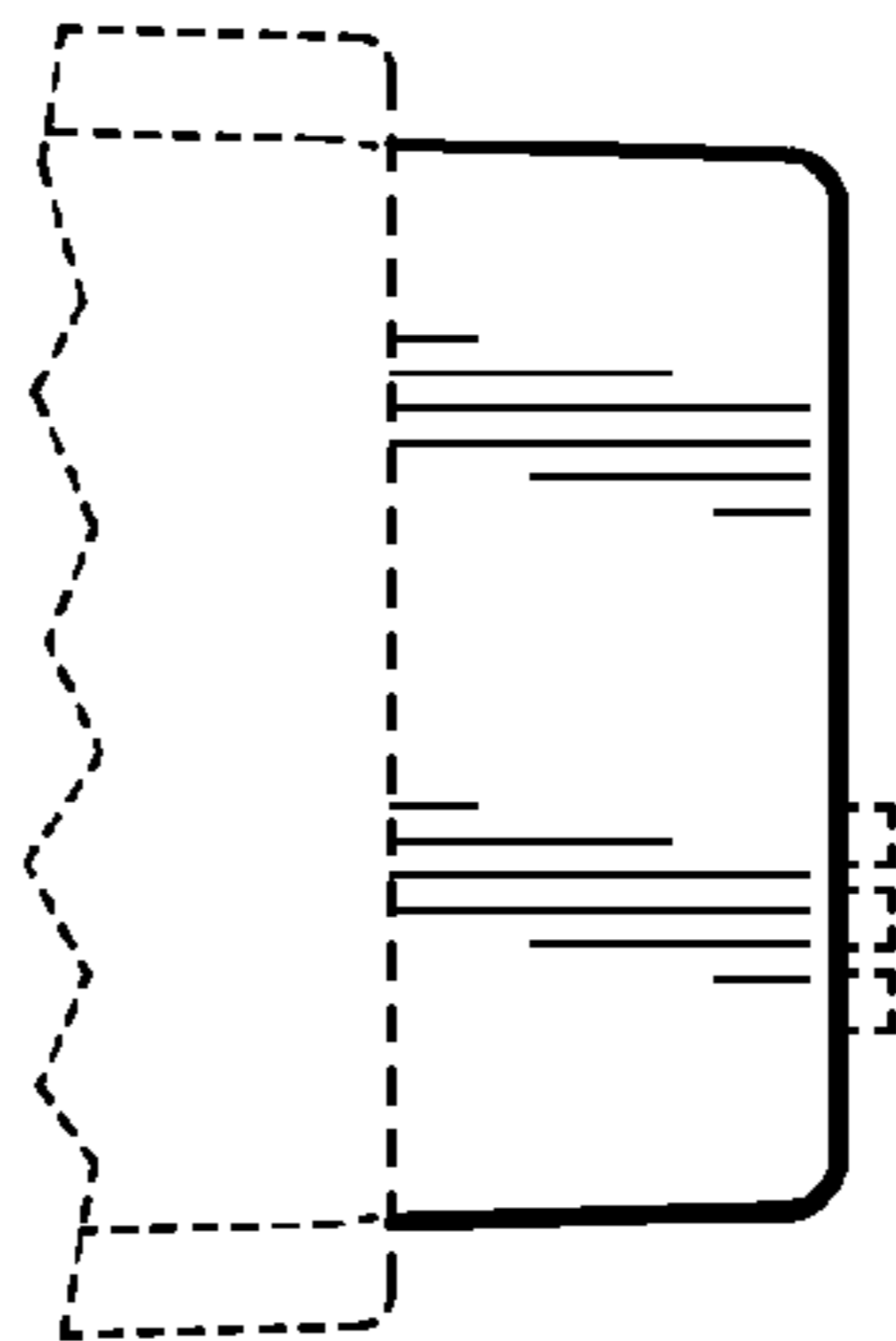
**Figure 2**



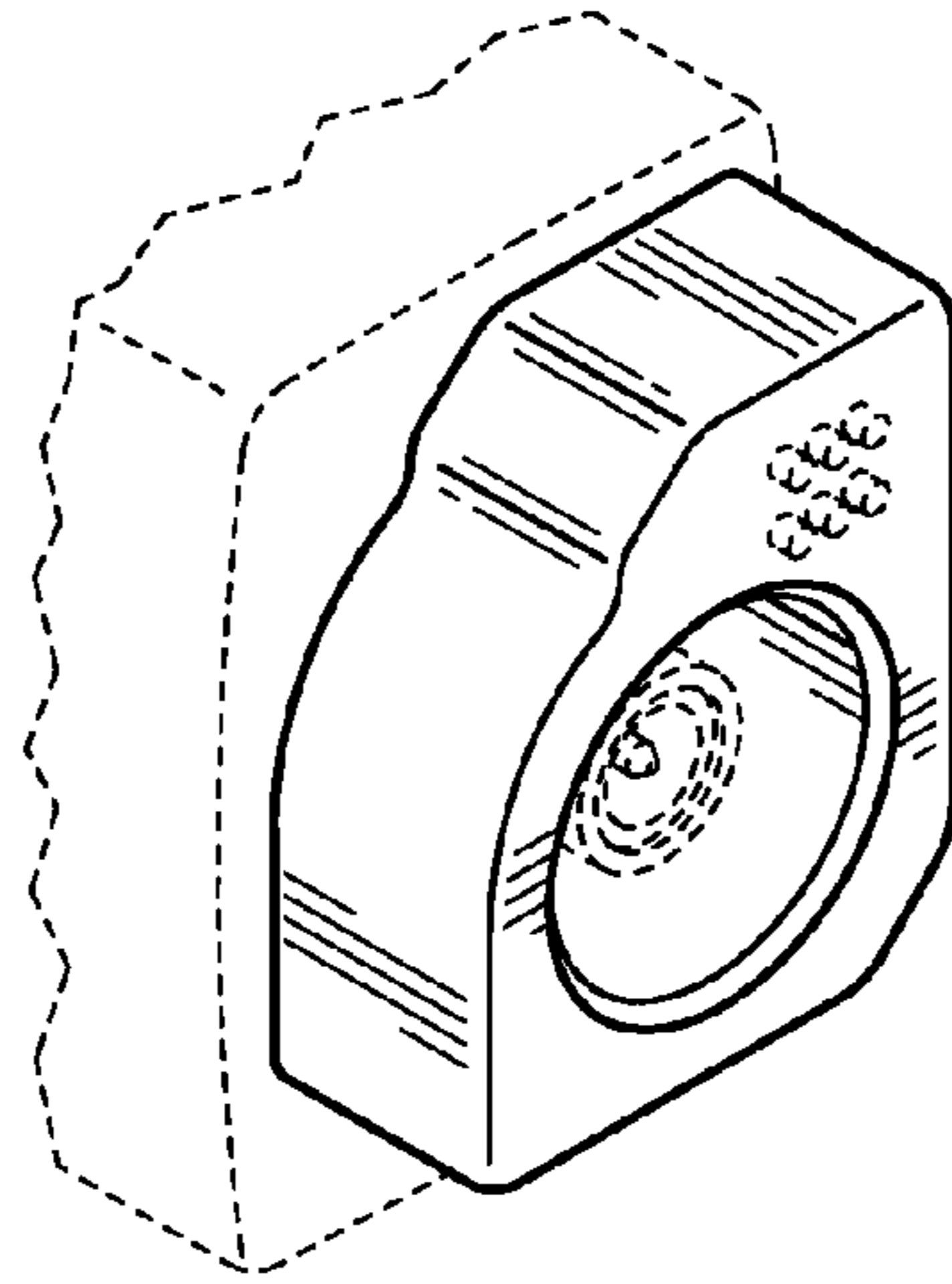
**Figure 4**



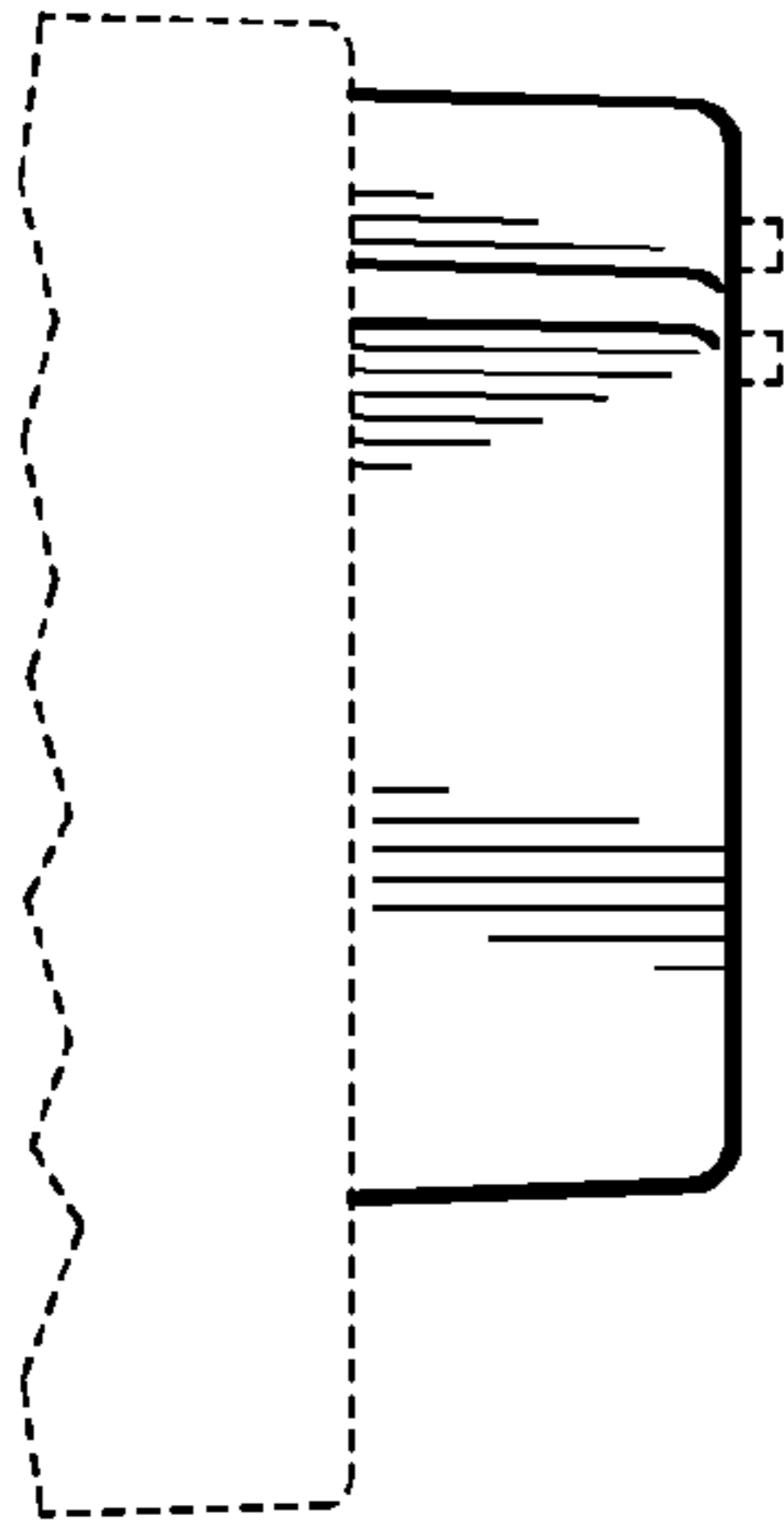
**Figure 5**



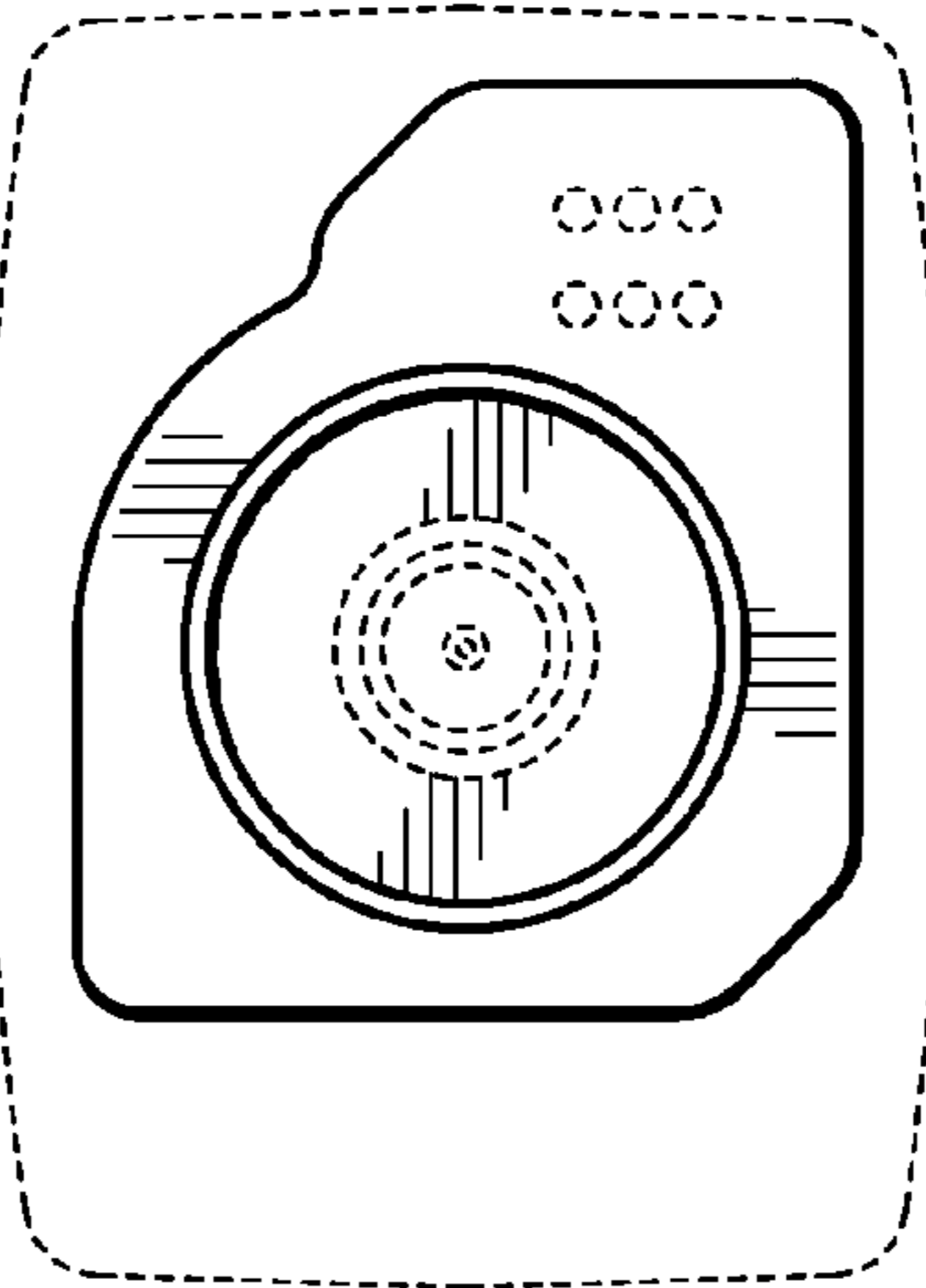
**Figure 6**



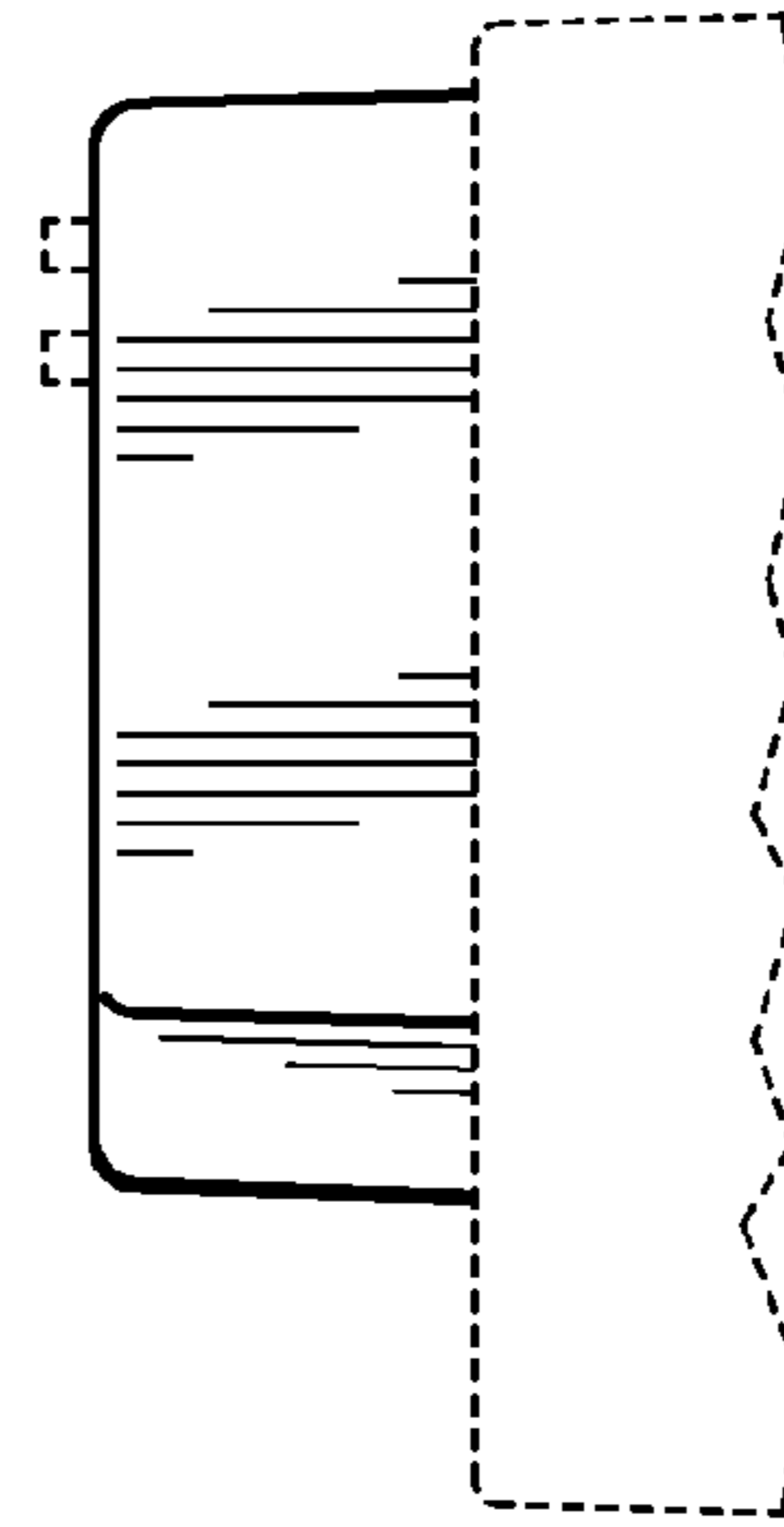
**Figure 7**



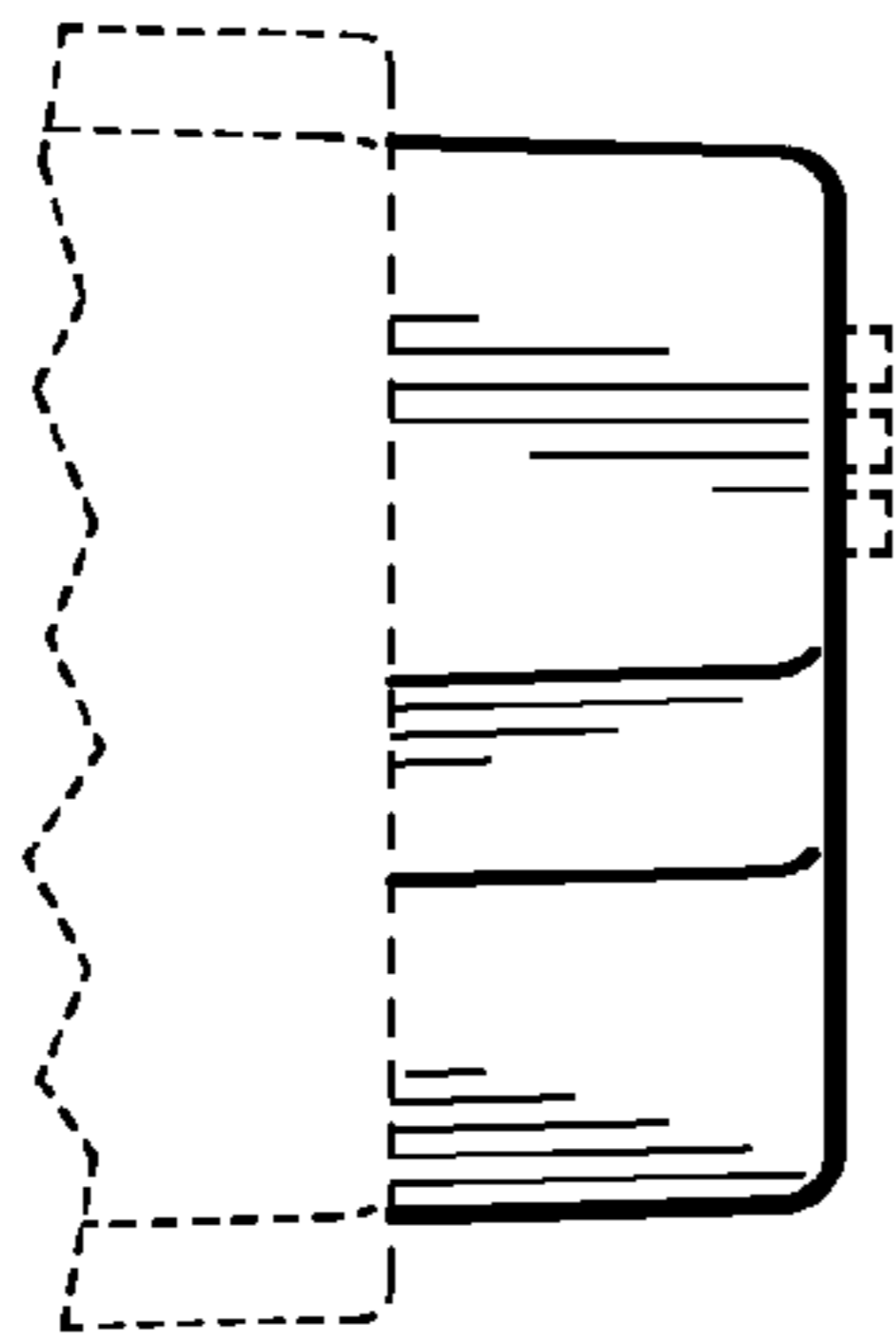
**Figure 9**



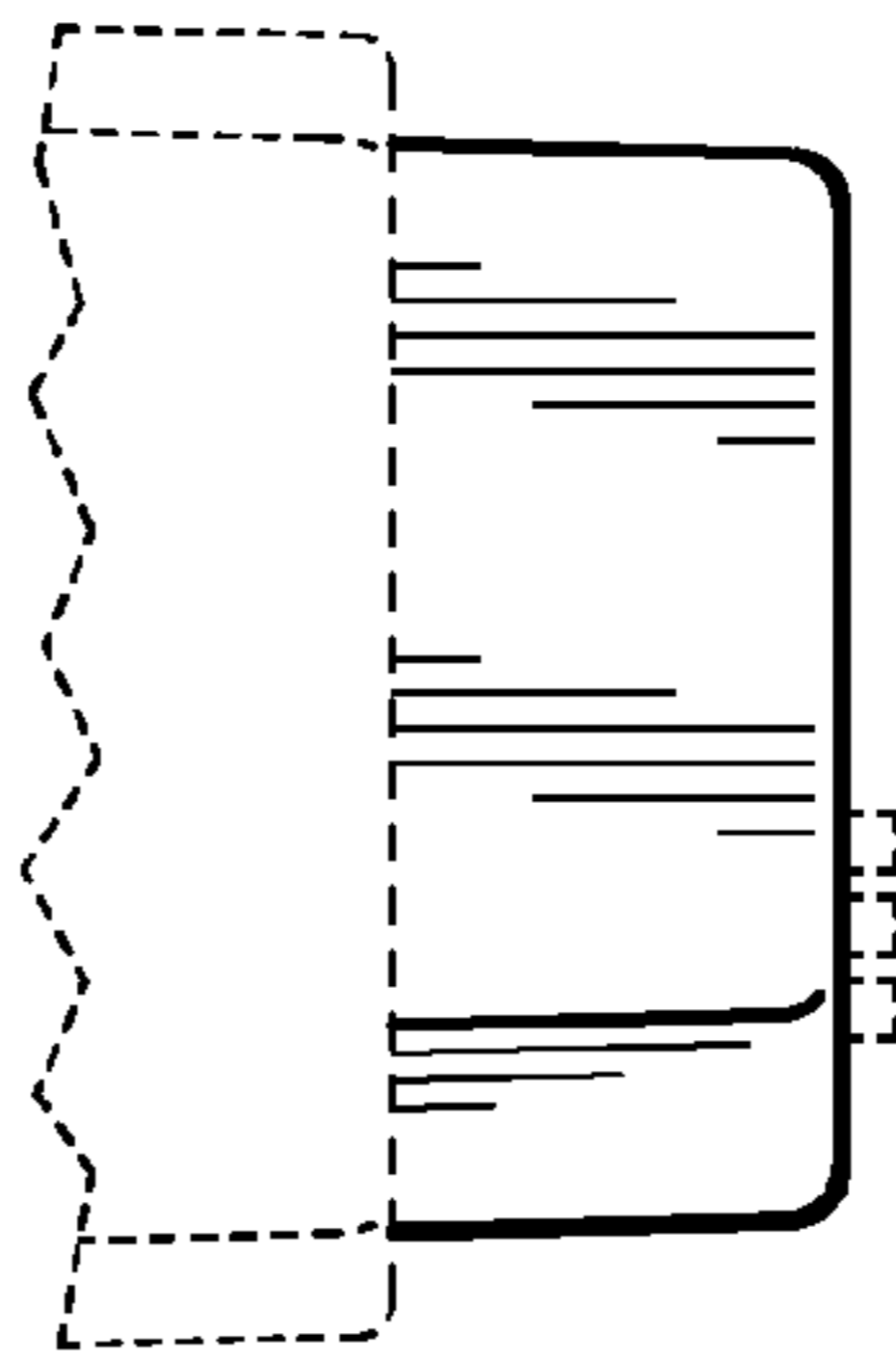
**Figure 8**



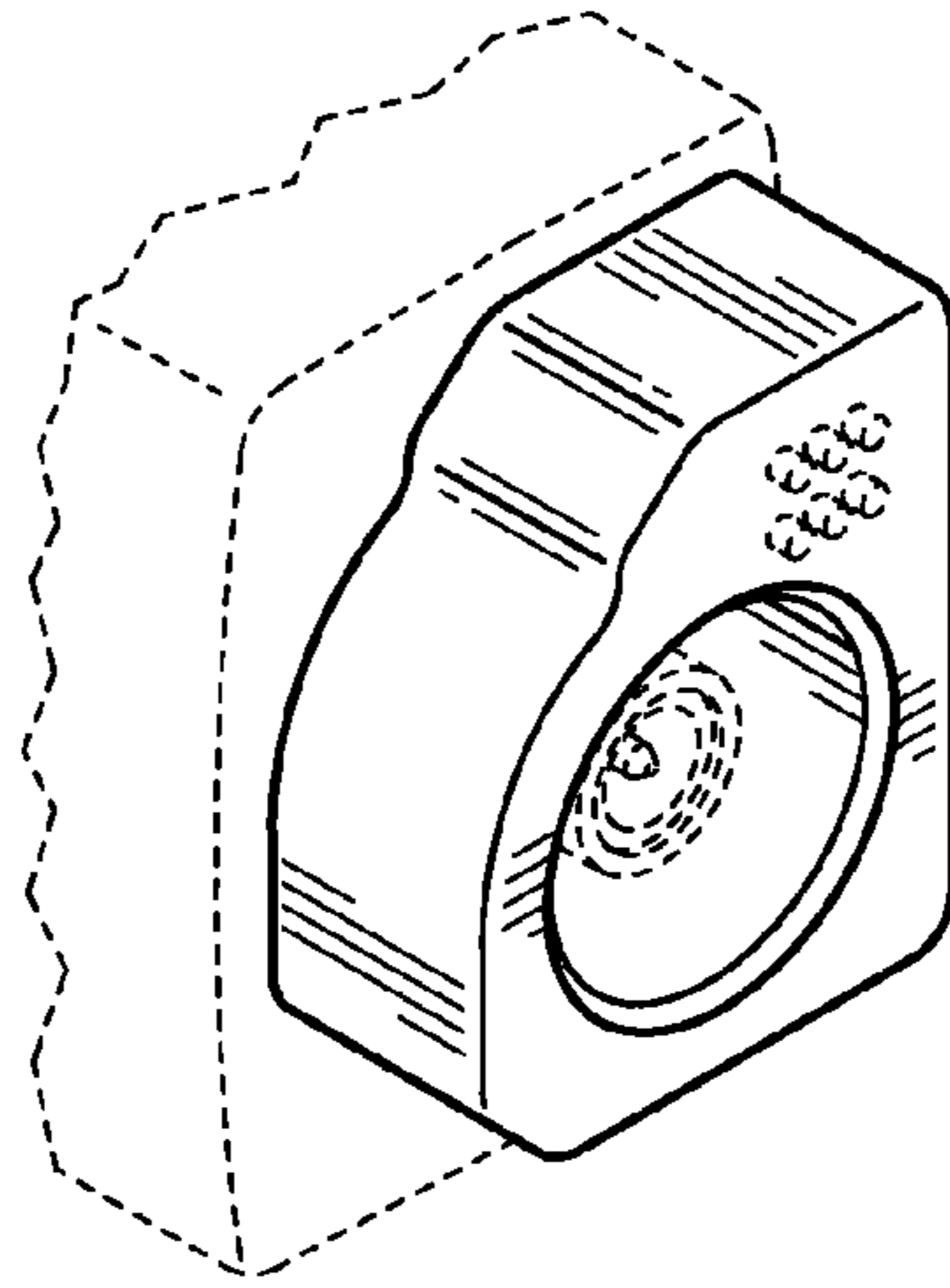
**Figure 10**



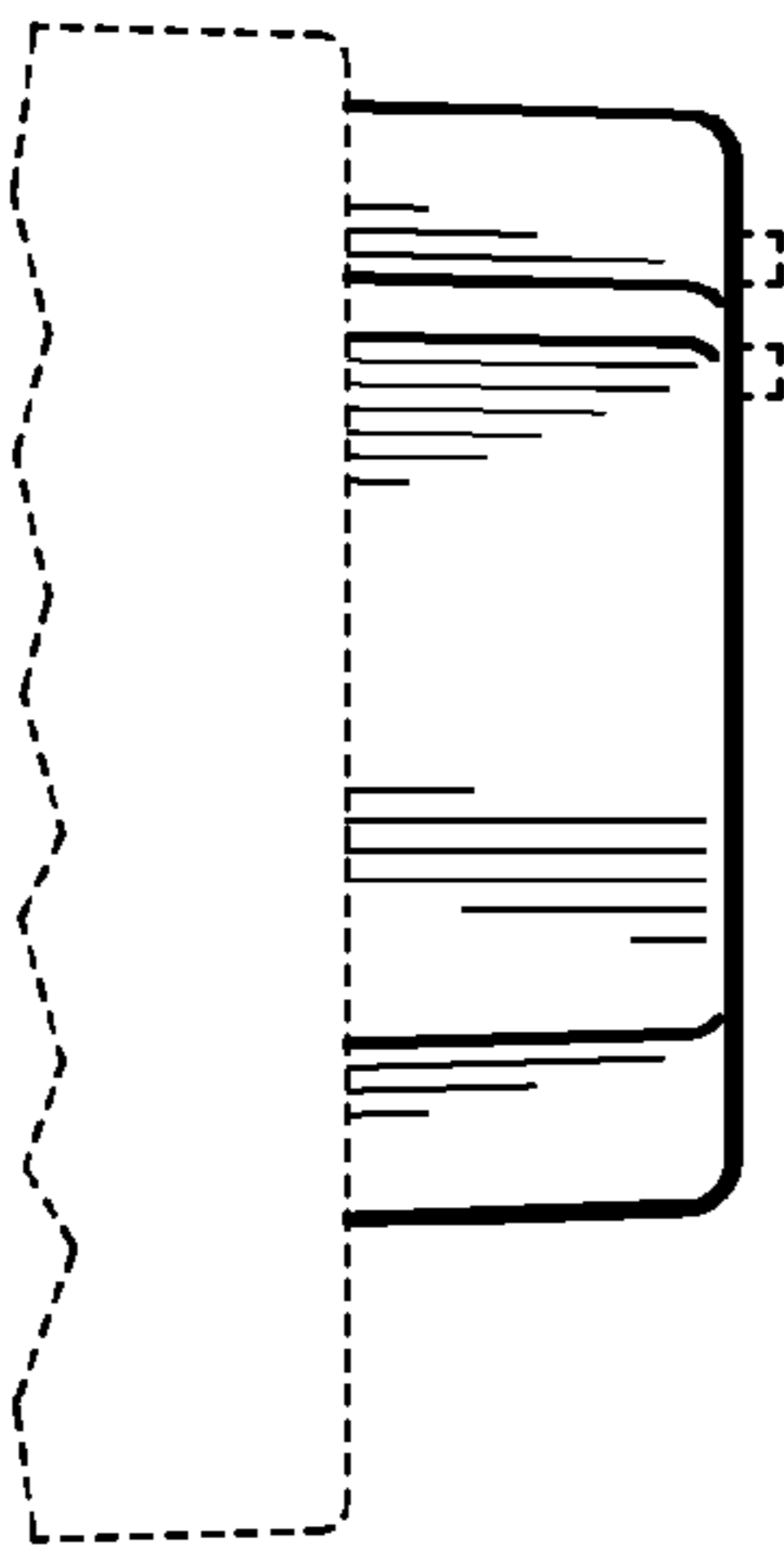
**Figure 11**



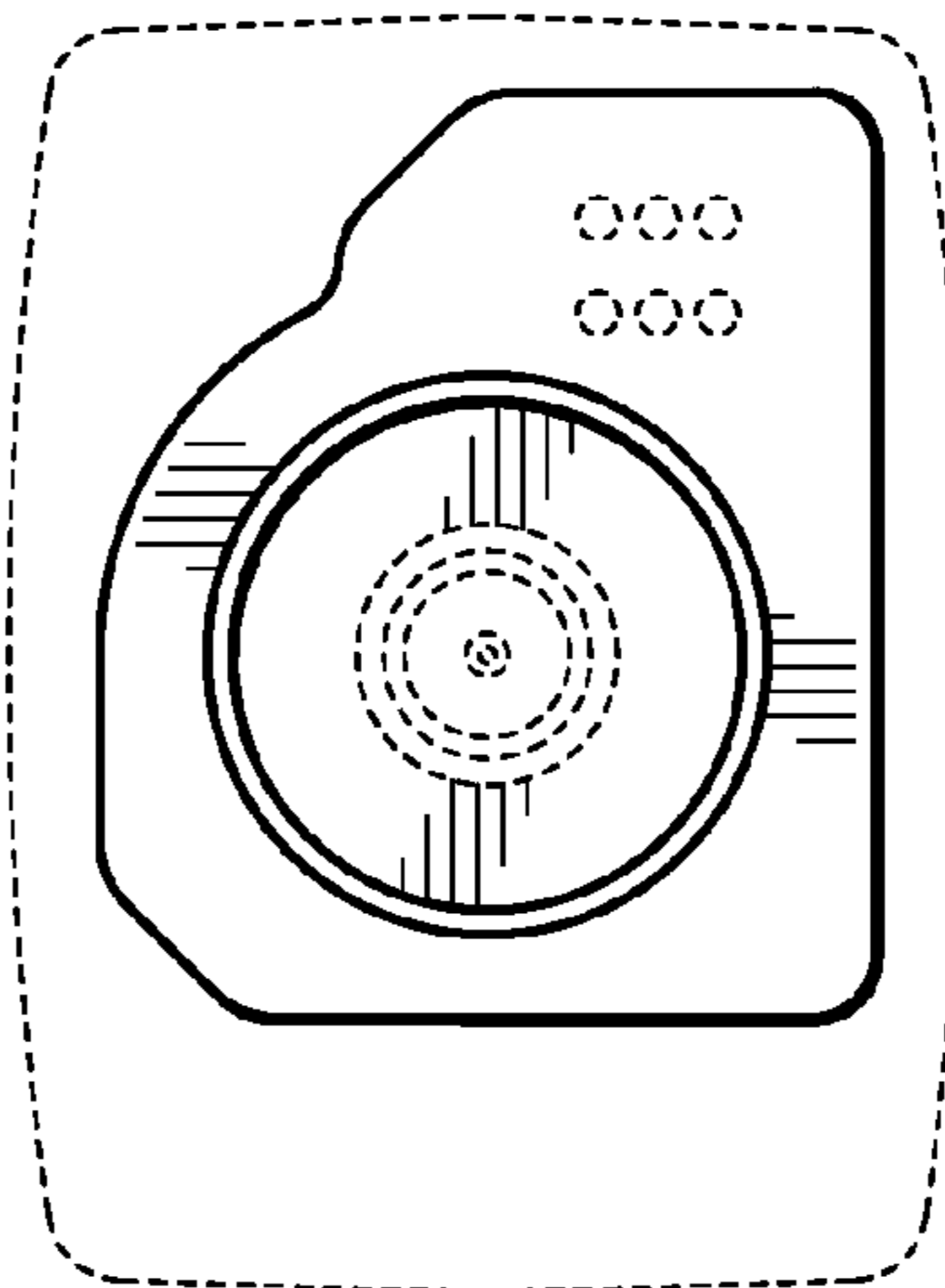
**Figure 12**



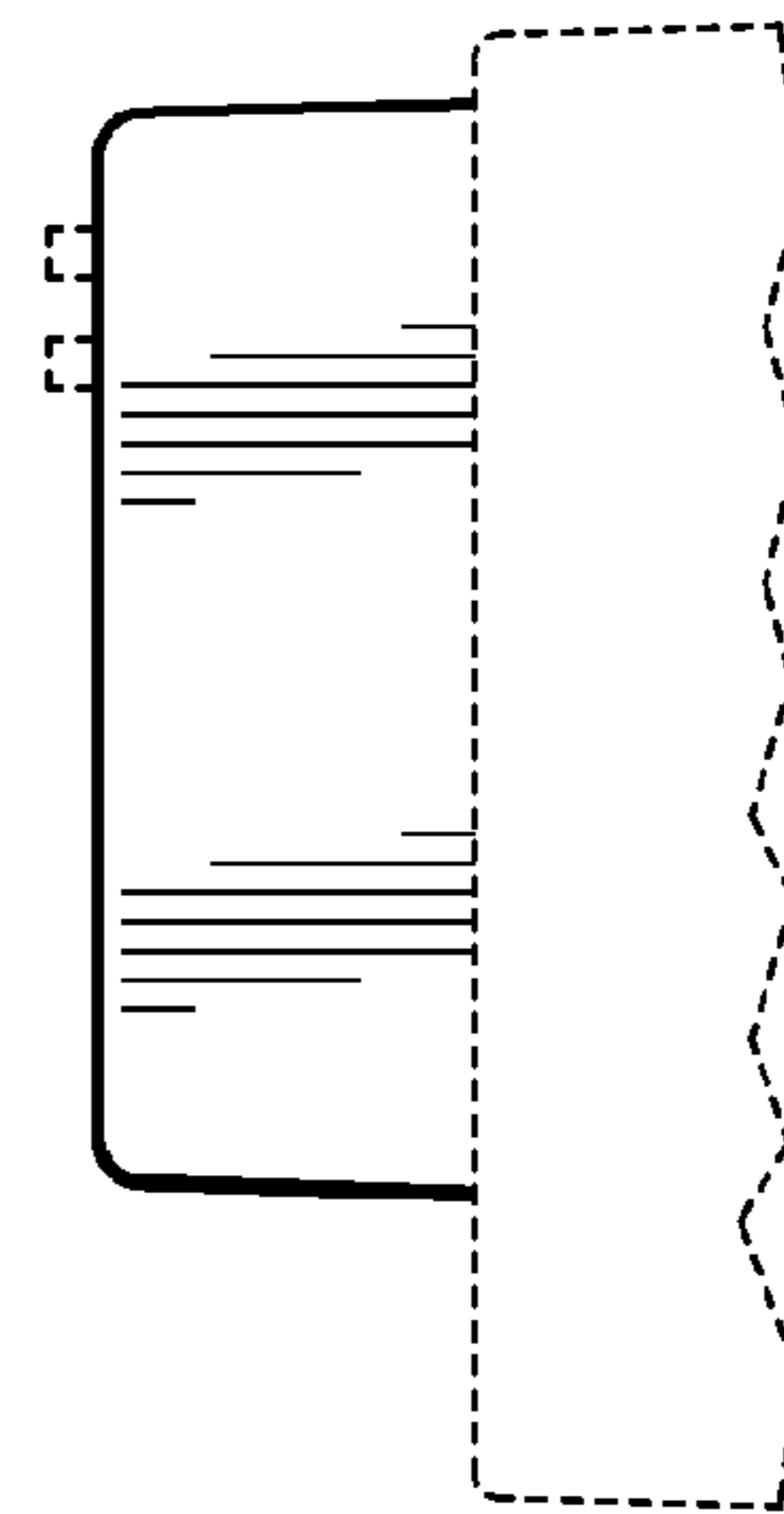
**Figure 13**



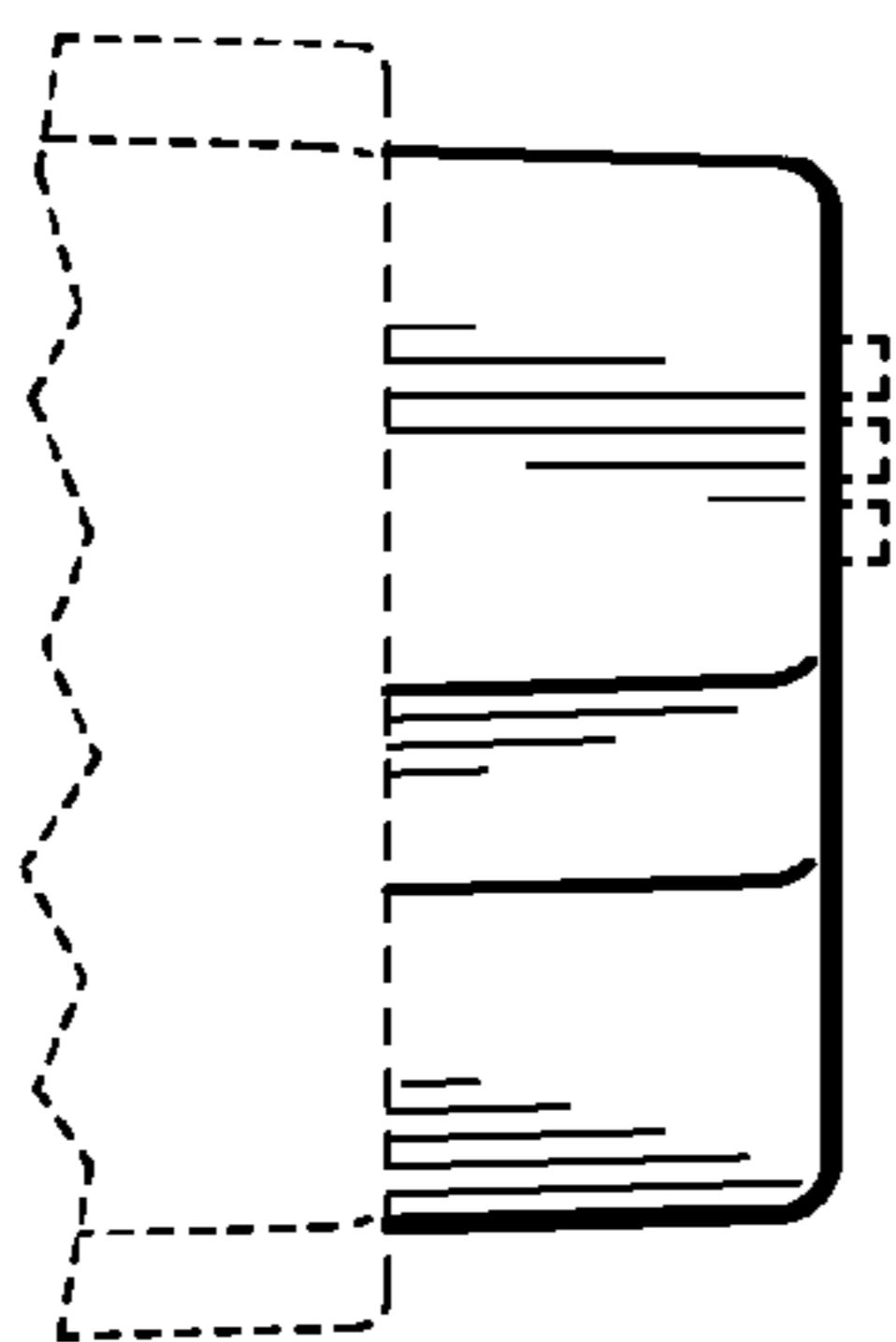
**Figure 15**



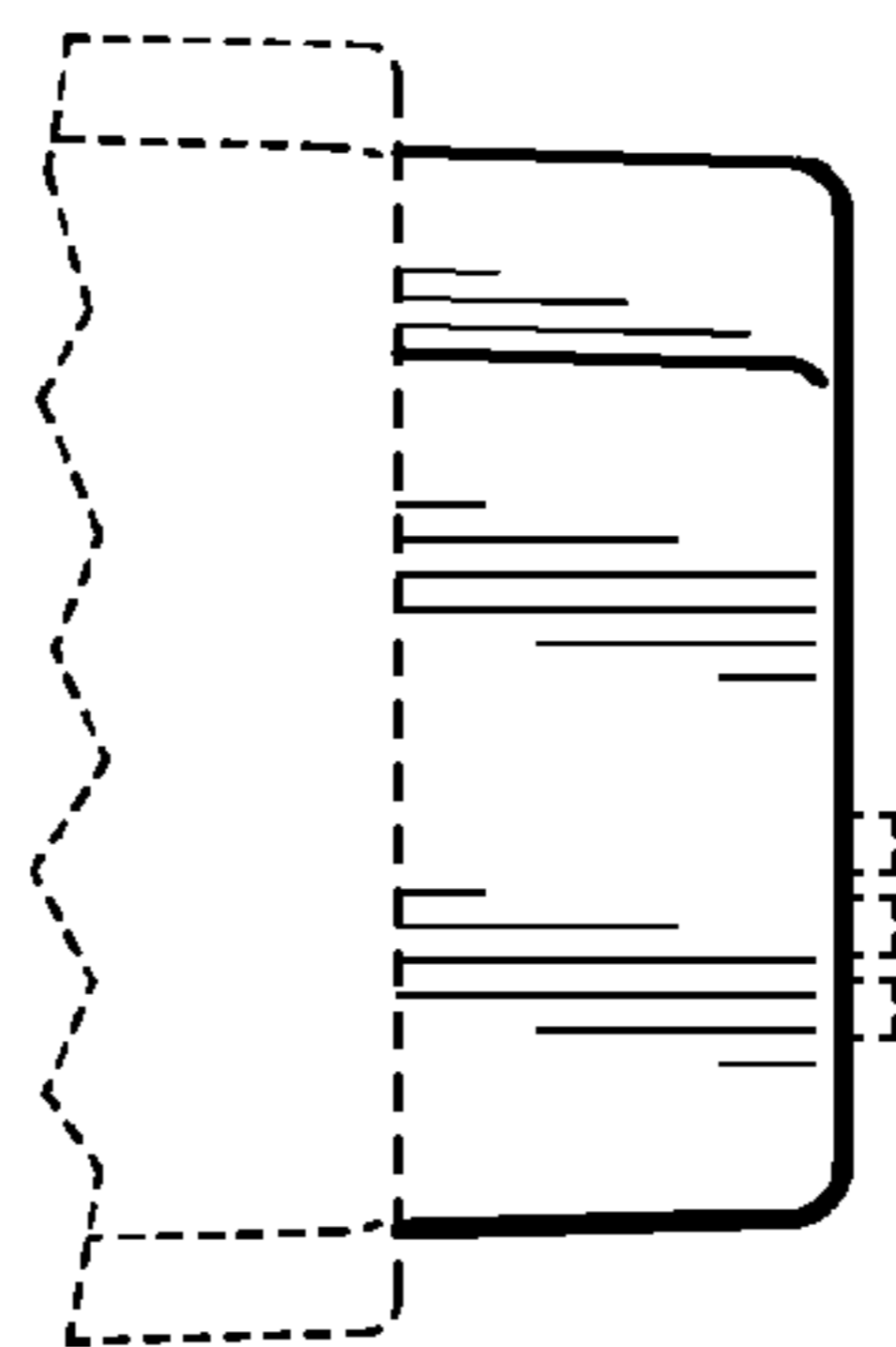
**Figure 14**



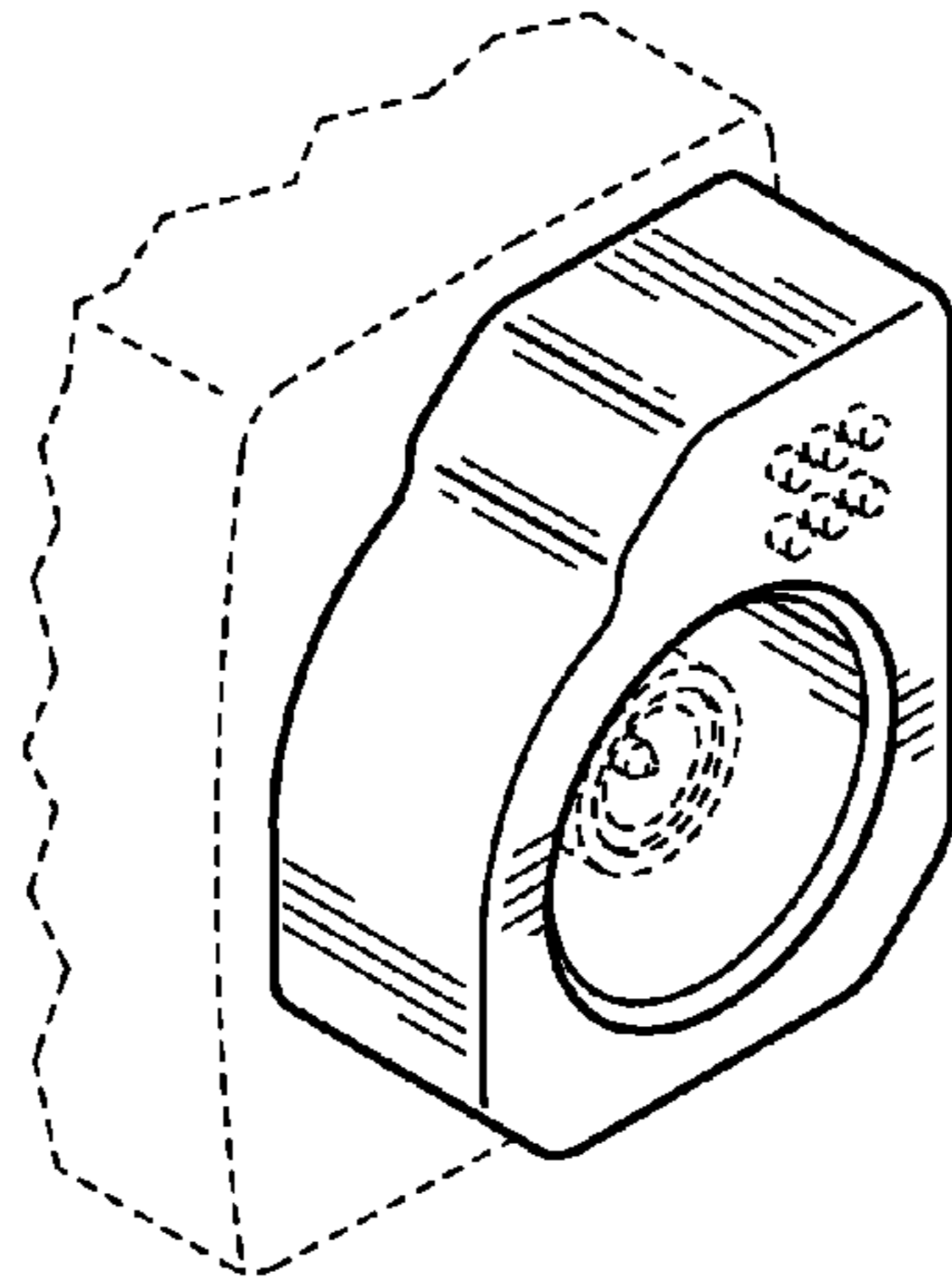
**Figure 16**



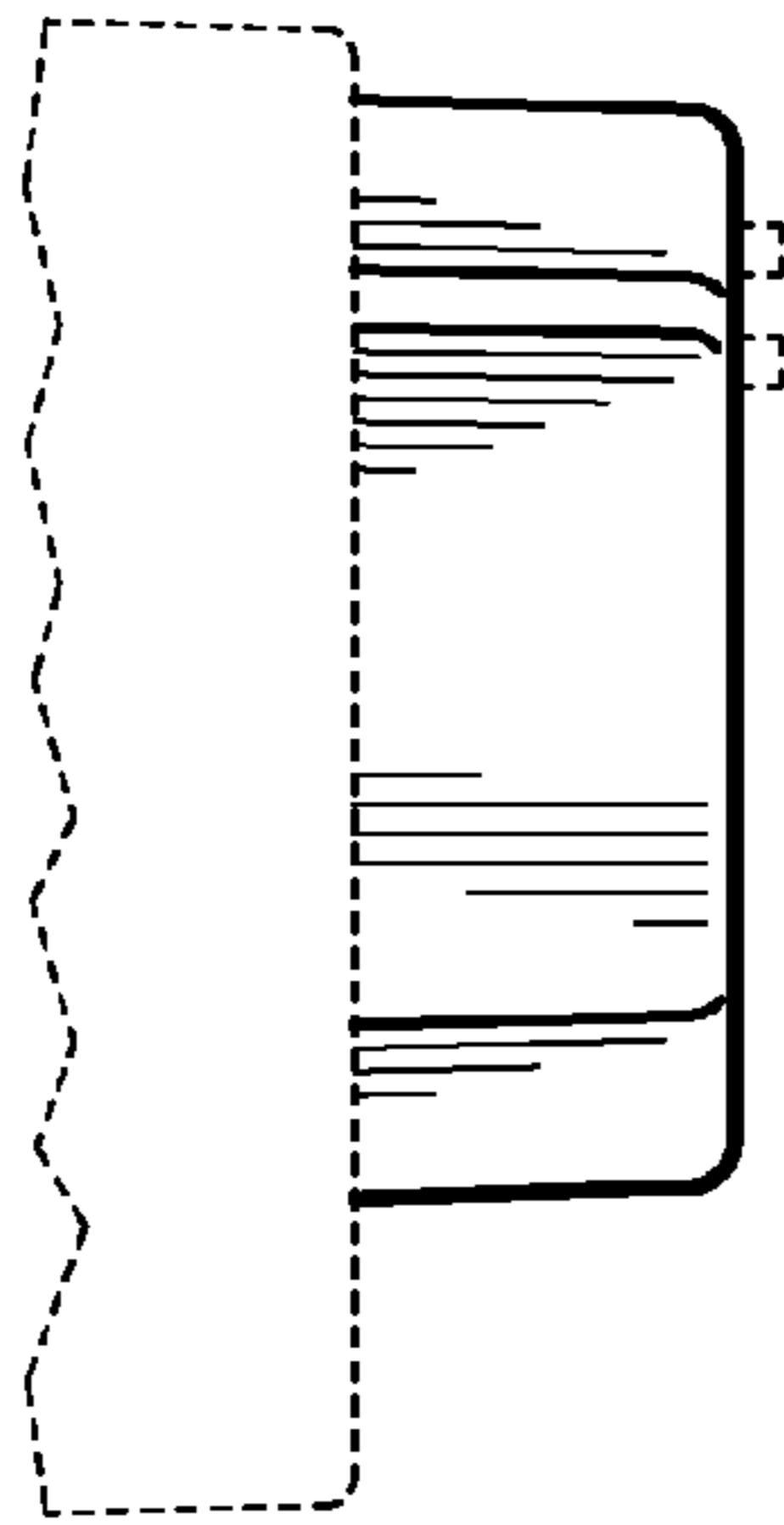
**Figure 17**



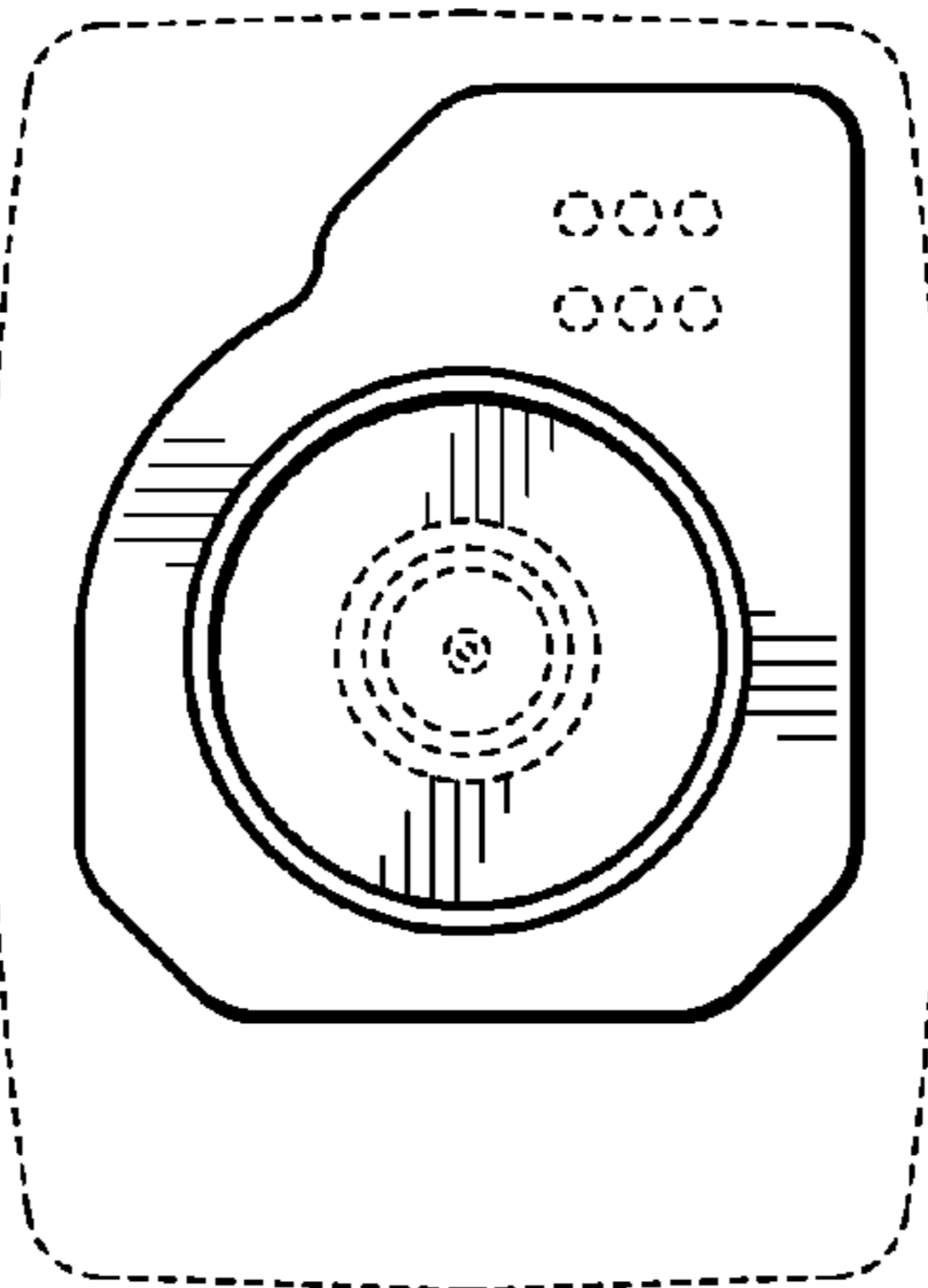
**Figure 18**



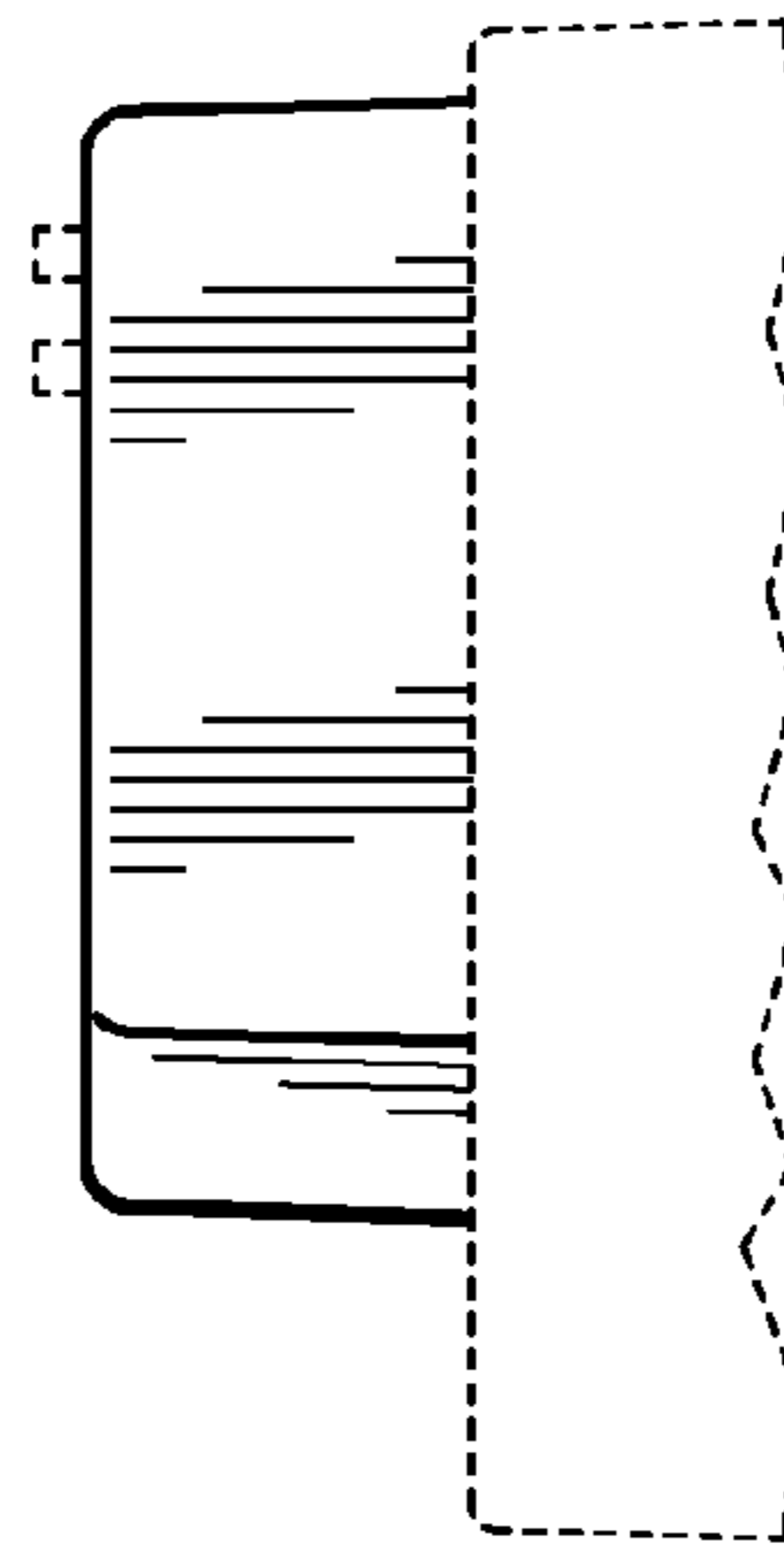
**Figure 19**



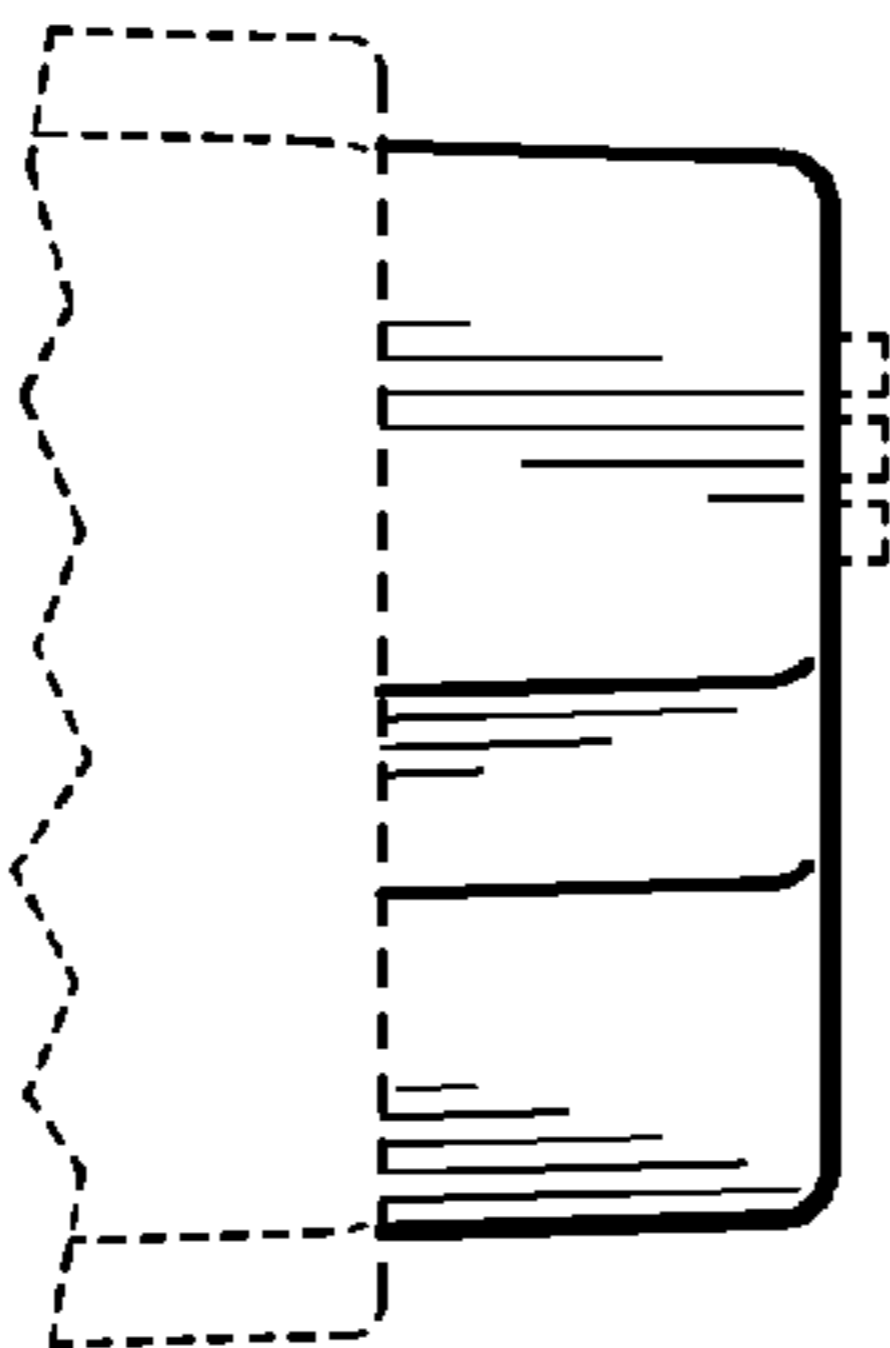
**Figure 21**



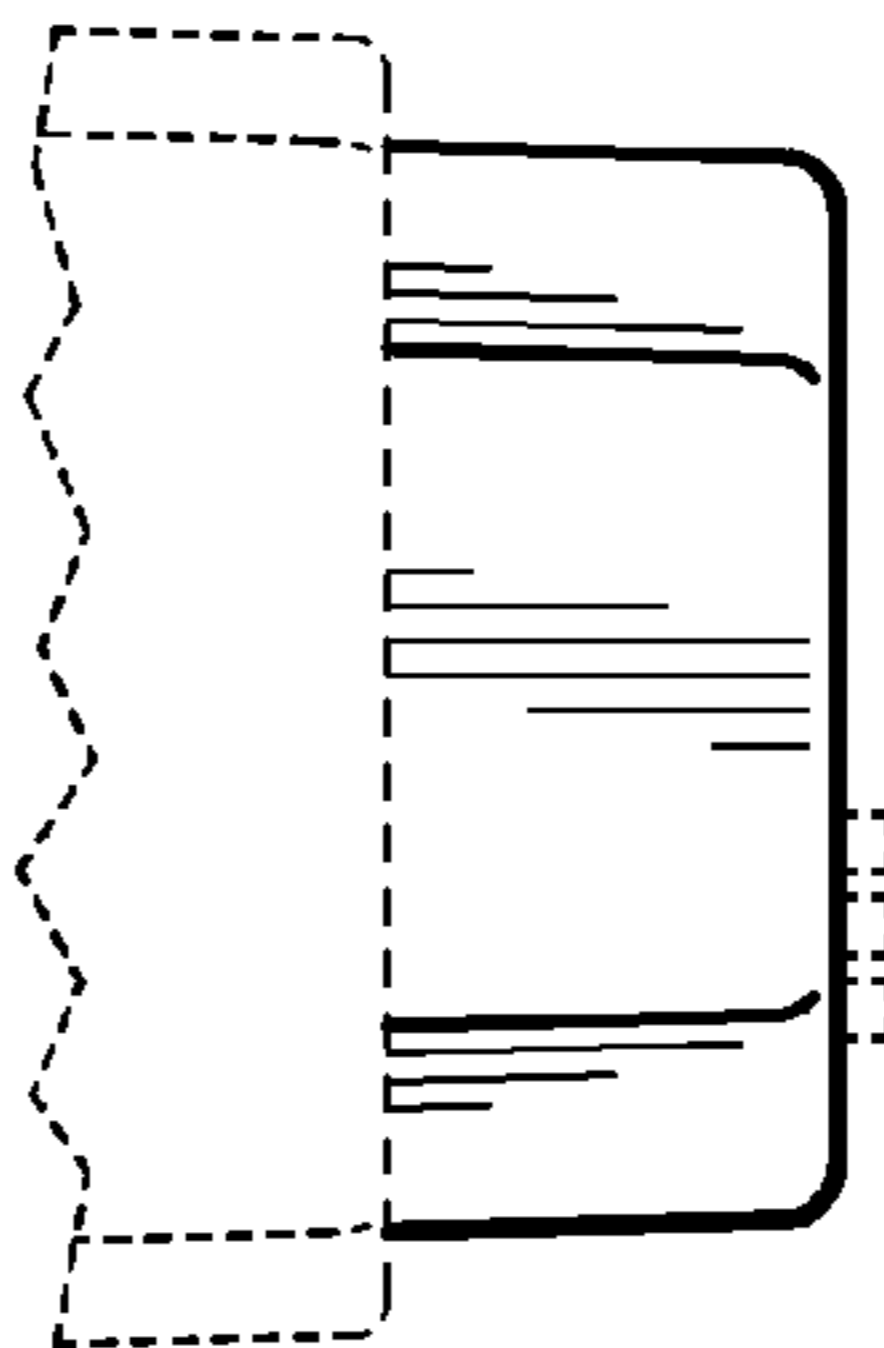
**Figure 20**



**Figure 22**



**Figure 23**



**Figure 24**