

US00D663267S

(12) **United States Design Patent**
Kim et al.

(10) **Patent No.:** **US D663,267 S**
(45) **Date of Patent:** **** Jul. 10, 2012**

(54) **ADAPTOR FOR CELLULAR PHONE**

(75) Inventors: **Hyojin Kim**, Seoul (KR); **Joonhyung Kim**, Gyeonggi-do (KR)

(73) Assignee: **LG Electronics Inc.**, Seoul (KR)

(**) Term: **14 Years**

(21) Appl. No.: **29/410,068**

(22) Filed: **Jan. 4, 2012**

(30) **Foreign Application Priority Data**

Jul. 19, 2011 (KR) 30-2011-0029926

(51) **LOC (9) Cl.** **13-02**

(52) **U.S. Cl.** **D13/110**

(58) **Field of Classification Search** D13/110,
D13/107, 108, 123, 133, 137.1, 138.1, 199;
174/53, 54, 59, 61; 307/150, 151; 320/111,
320/114; 363/132, 140, 142, 143, 146; 439/105,
439/131, 166, 171-173, 218, 518, 692, 956;
D14/240, 251, 253, 432, 433, 434

See application file for complete search history.

(56) **References Cited**

U.S. PATENT DOCUMENTS

D338,188 S * 8/1993 Lee et al. D13/110
D454,538 S * 3/2002 Glickman D13/110

D456,008 S * 4/2002 Kawanobe et al. D13/110
6,544,051 B1 * 4/2003 Su 439/131
D478,546 S * 8/2003 Andre et al. D13/110
D562,766 S * 2/2008 Yang D13/110
D567,174 S * 4/2008 Jidaisho D13/110
D579,410 S * 10/2008 Hanada et al. D13/110
D587,192 S * 2/2009 McGinley et al. D13/110
D595,224 S * 6/2009 Seil et al. D13/110
D601,500 S * 10/2009 Green et al. D13/110
D611,409 S * 3/2010 Green et al. D13/110

* cited by examiner

Primary Examiner — Derrick Holland

(74) *Attorney, Agent, or Firm* — Morgan, Lewis & Bockius LLP

(57) **CLAIM**

The ornamental design for an adaptor for cellular phone, as shown and described.

DESCRIPTION

FIG. 1 is a front, right side, perspective view of an adaptor for cellular phone showing our new design;
FIG. 2 is a front view thereof;
FIG. 3 is a rear view thereof;
FIG. 4 is a left side view thereof;
FIG. 5 is a right side view thereof;
FIG. 6 is a top view thereof; and,
FIG. 7 is a bottom view thereof.

1 Claim, 3 Drawing Sheets

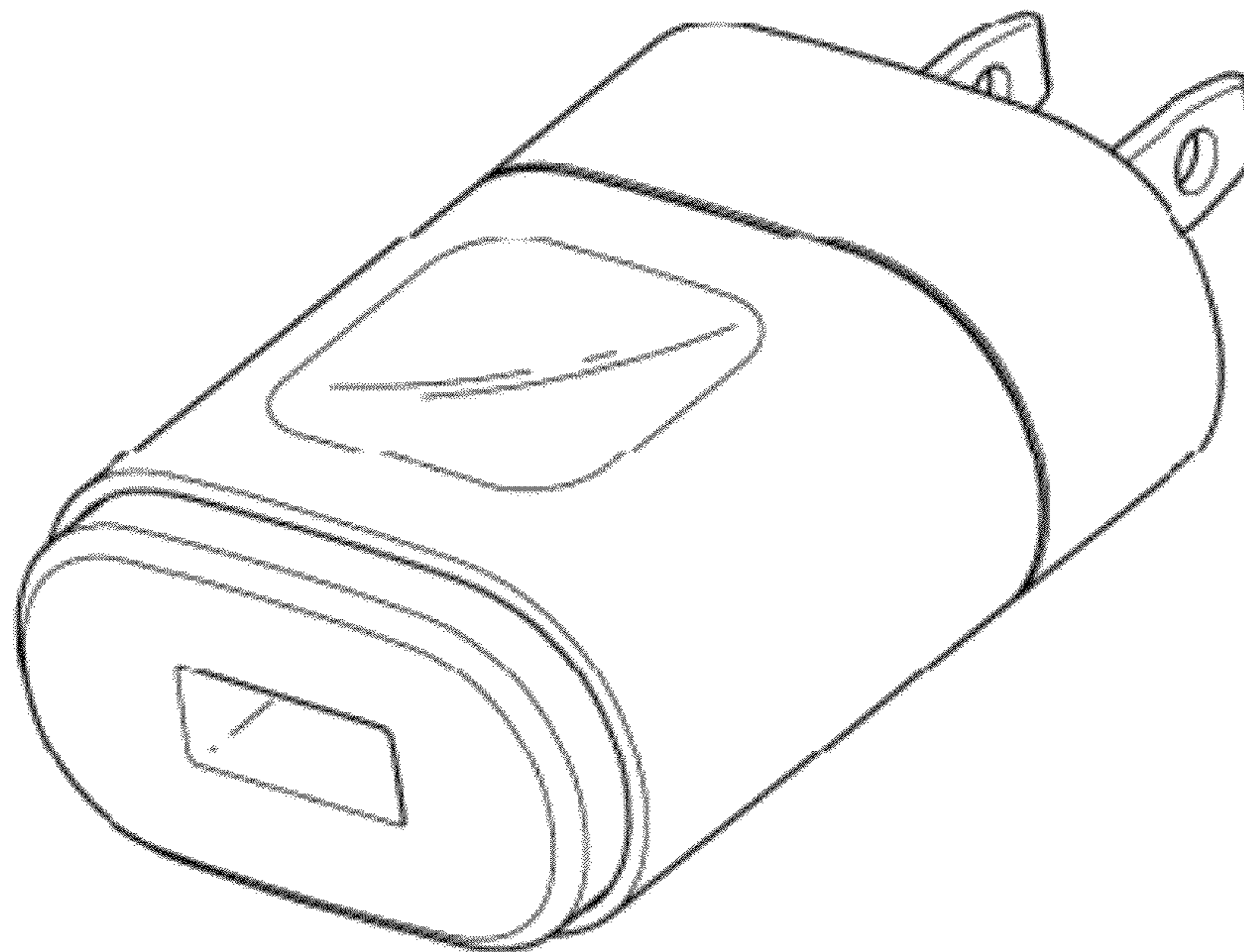

FIG. 1

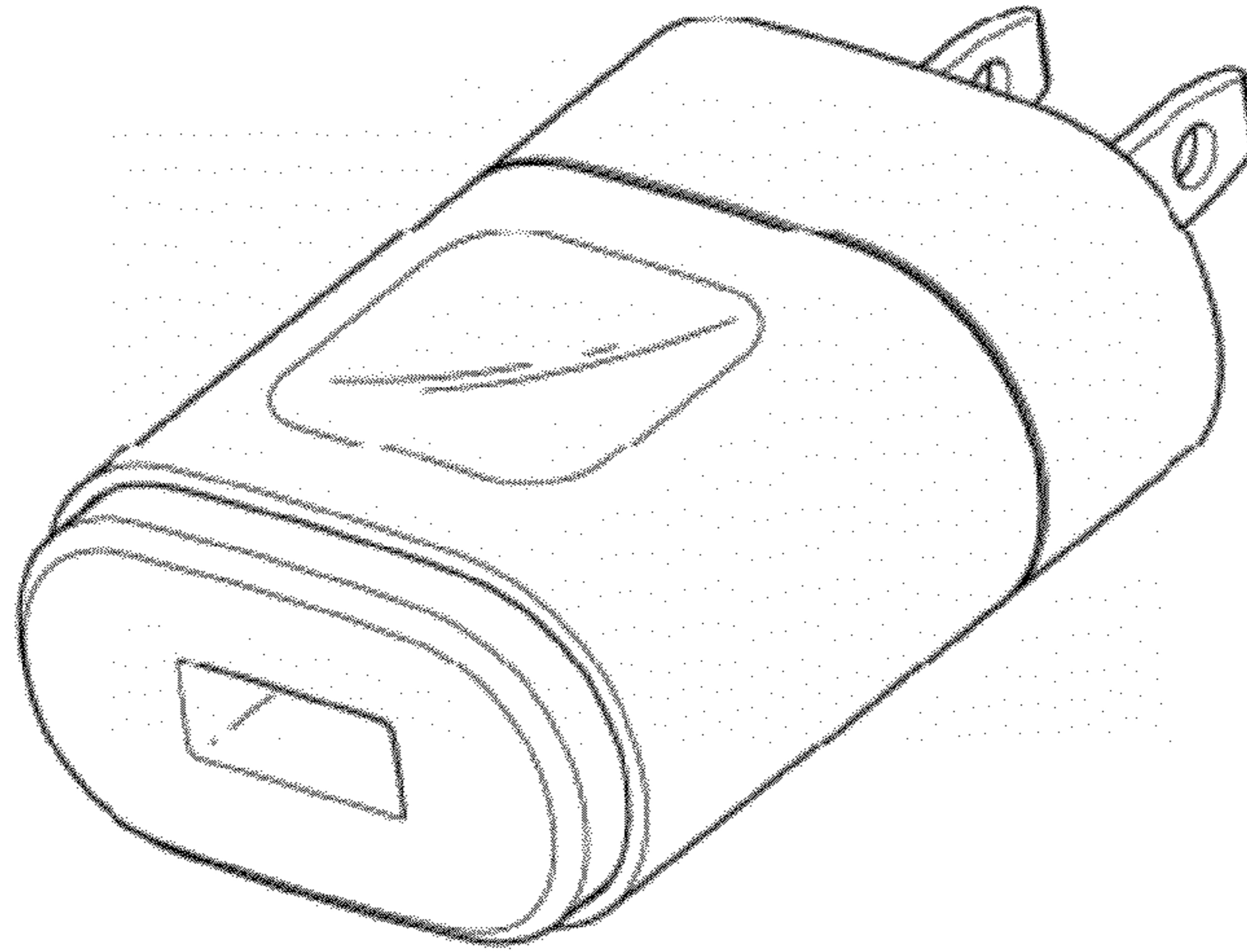

FIG. 2

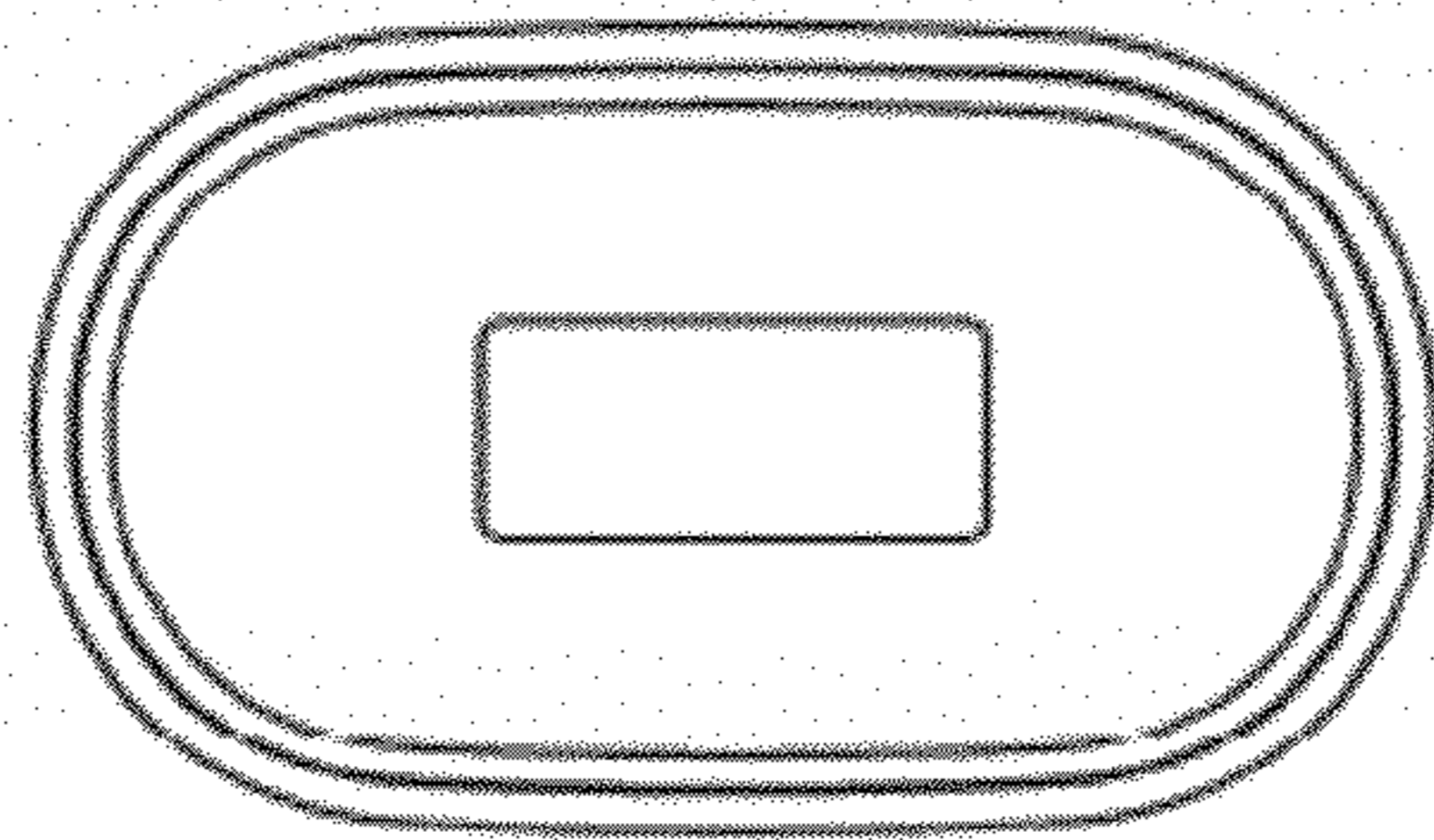

FIG. 3

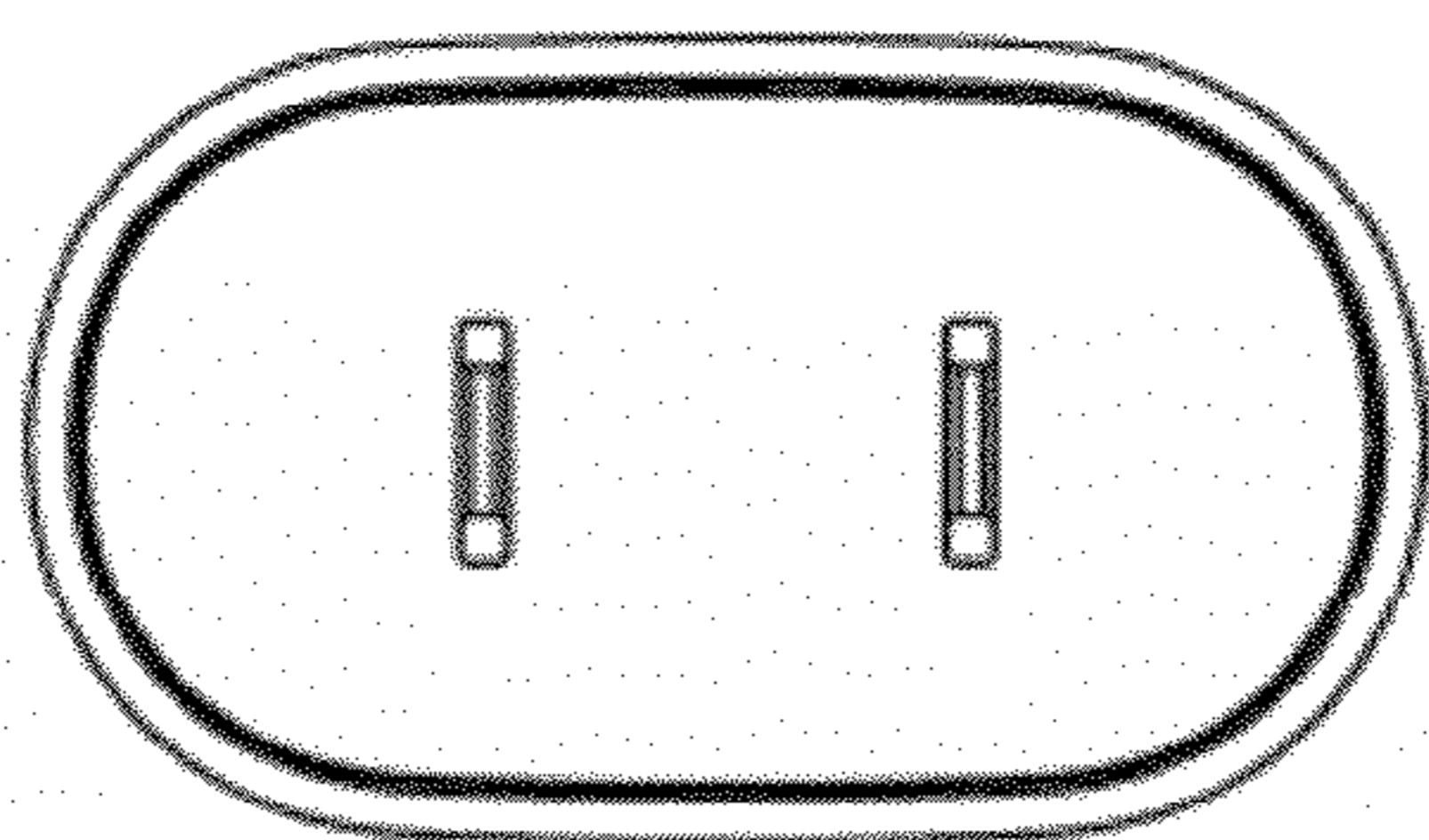

FIG. 4

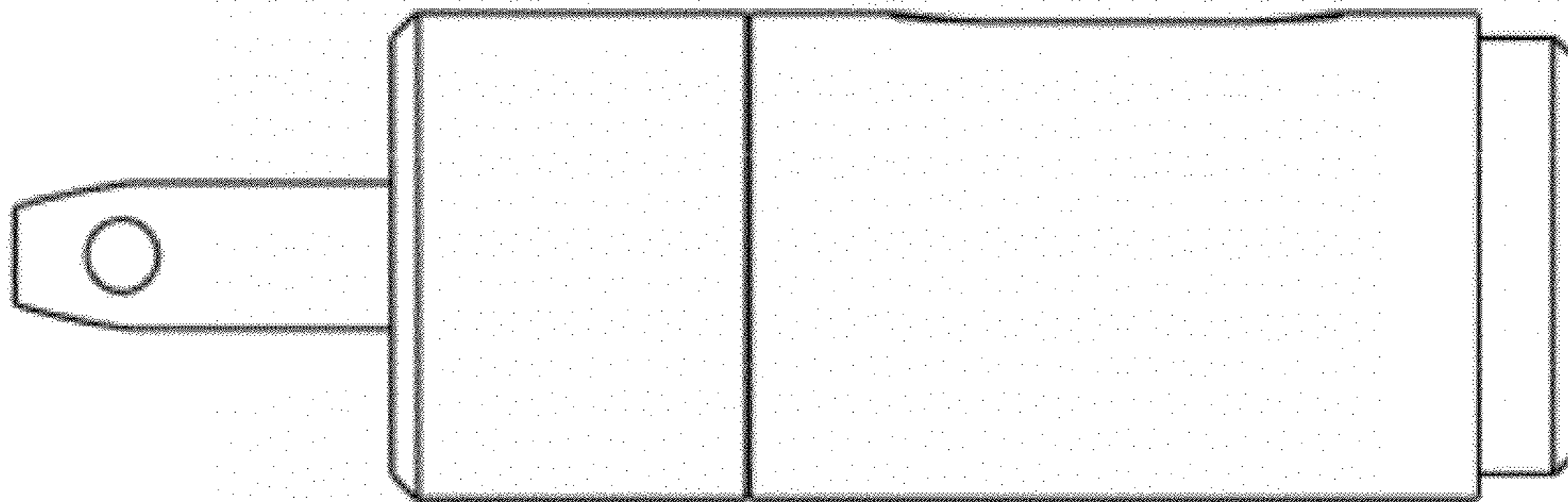

FIG. 5

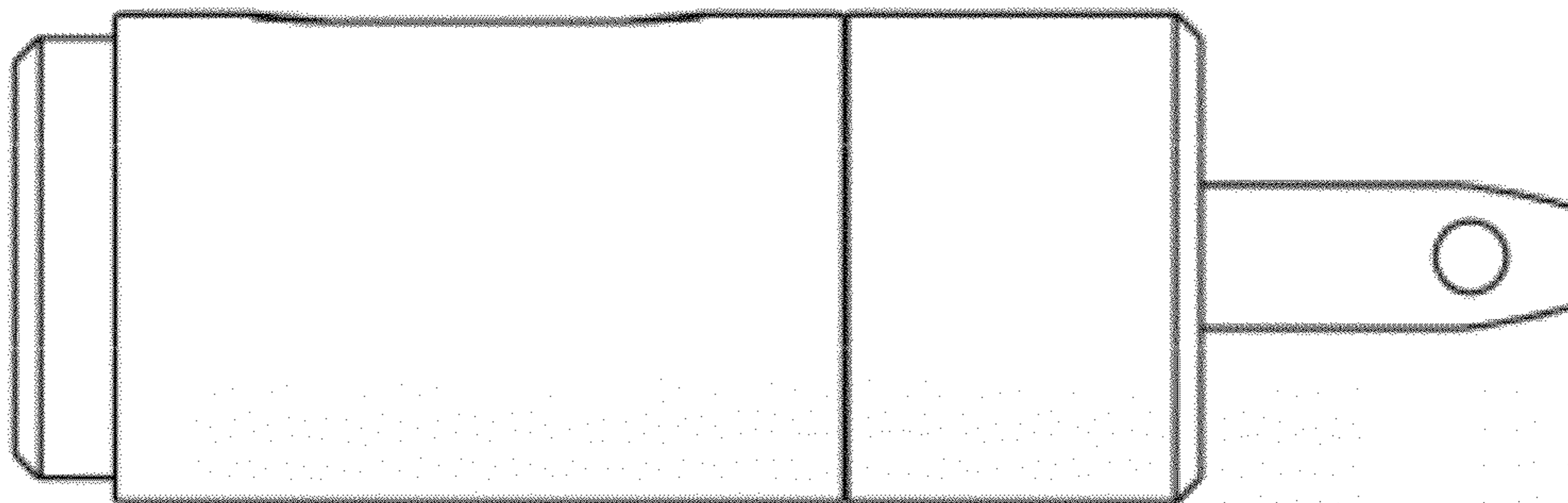

FIG. 6

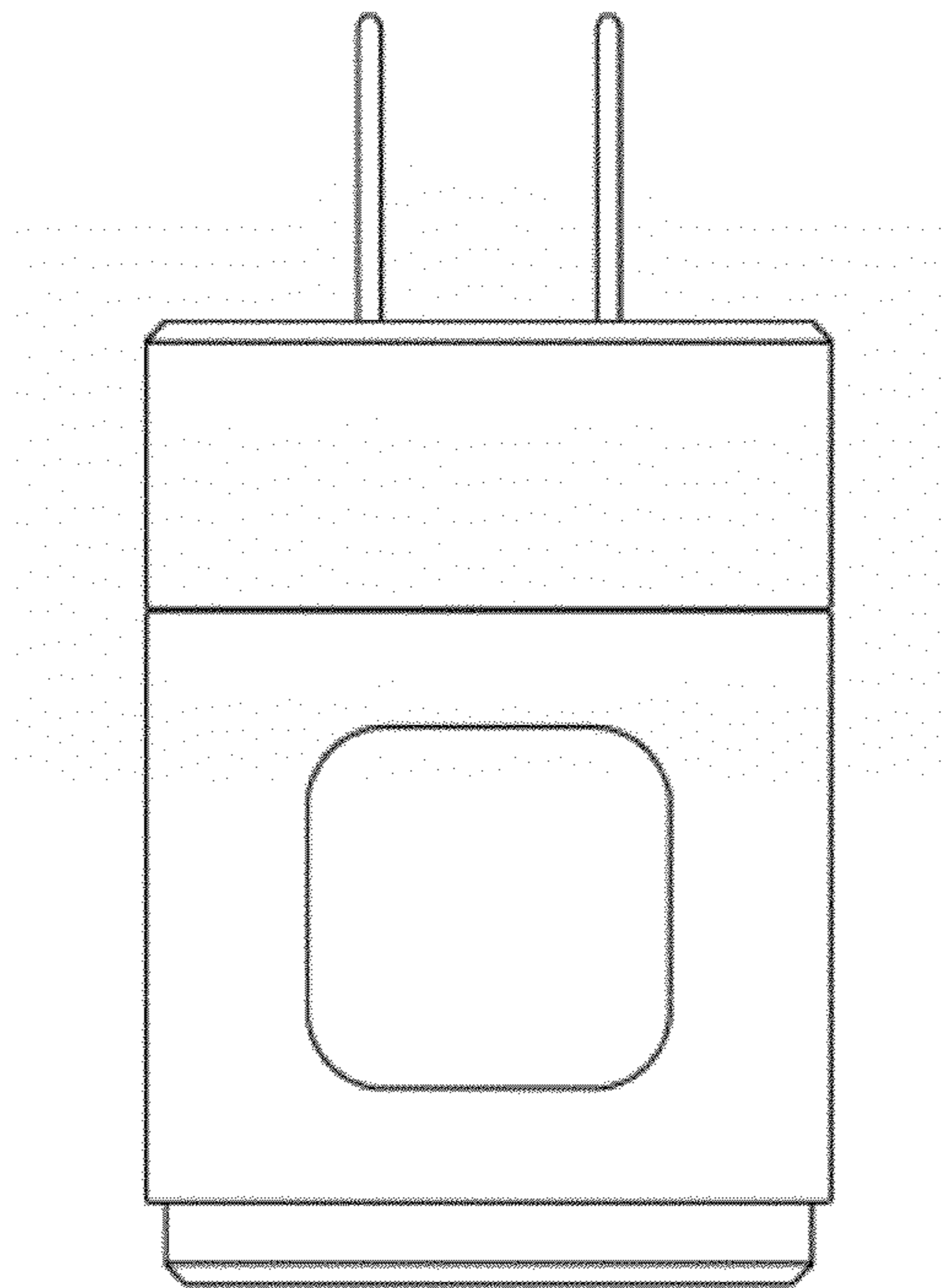

FIG. 7

