



US00D663242S

(12) **United States Design Patent**
Zhang et al.

(10) **Patent No.:** **US D663,242 S**
(45) **Date of Patent:** **** Jul. 10, 2012**

(54) **ELECTRIC VEHICLE**

5,904,392 A * 5/1999 Mainwal 296/78.1
6,942,053 B2 * 9/2005 Hinton 180/209
D579,851 S * 11/2008 Fermil D12/402

(75) Inventors: **Xue-qing Zhang**, SuZhou (CN); **Xue Li**,
SuZhou (CN)

(73) Assignee: **Suzhou Eagle Electric Vehicle
Manufacturing Co., Ltd.**, Suzhou,
Jiangsu Province (CN)

(**) Term: **14 Years**

(21) Appl. No.: **29/393,992**

(22) Filed: **Jun. 10, 2011**

(30) **Foreign Application Priority Data**

Mar. 3, 2011 (CN) 2011 3 0033268

(51) **LOC (9) Cl.** **12-11**

(52) **U.S. Cl.** **D12/110**

(58) **Field of Classification Search** D12/110,
D12/107, 401, 402, 404; 180/218, 219, 220,
180/65.1, 65.5-65.8, 68.1, 68.2, 68.5; 296/77.1,
296/78.1, 136.1, 136.01, 136.07, 193.12,
296/200, 201, 100.11, 136.11, 180.1, 187.13;
135/88.01, 88.03, 88.14, 88.15, 88.17;
150/166-168; 280/288.1-288.4, 304.3,
280/304.4, 756, 770

See application file for complete search history.

(56) **References Cited**

U.S. PATENT DOCUMENTS

D245,077 S * 7/1977 Newell D12/110
5,685,388 A * 11/1997 Bothwell et al. 180/219

OTHER PUBLICATIONS

Endless-sphere.com. Electric Vehicle Technology Forums. © 2000,
2002, 2005, 2007. Motorcycles with Canopies on pp. 4-7, and 9 of 22
[Retrieved on Mar. 5, 2012]. Retrieved from the Internet <URL:
[http://endless-sphere.com/forums/viewtopic.php?f=3999
&start=300](http://endless-sphere.com/forums/viewtopic.php?f=3999&start=300)>.*

* cited by examiner

Primary Examiner — Susan M Lee

Assistant Examiner — Linda G. Brooks

(74) *Attorney, Agent, or Firm* — Cheng-Ju Chiang

(57) **CLAIM**

The ornamental design for an electric vehicle, as shown and
described.

DESCRIPTION

FIG. 1 is a top, front and left side perspective view of an
electric vehicle showing our new design;
FIG. 2 is a front elevation view thereof;
FIG. 3 is a rear elevation view thereof;
FIG. 4 is a left side elevation view thereof;
FIG. 5 is a right side elevation view thereof; and,
FIG. 6 is a top side elevation view thereof.

The bottom has no claimed ornamental features. The broken
lines showing of elements in the figures are for the purpose of
illustrating environment and form no part of the claimed
design.

1 Claim, 6 Drawing Sheets

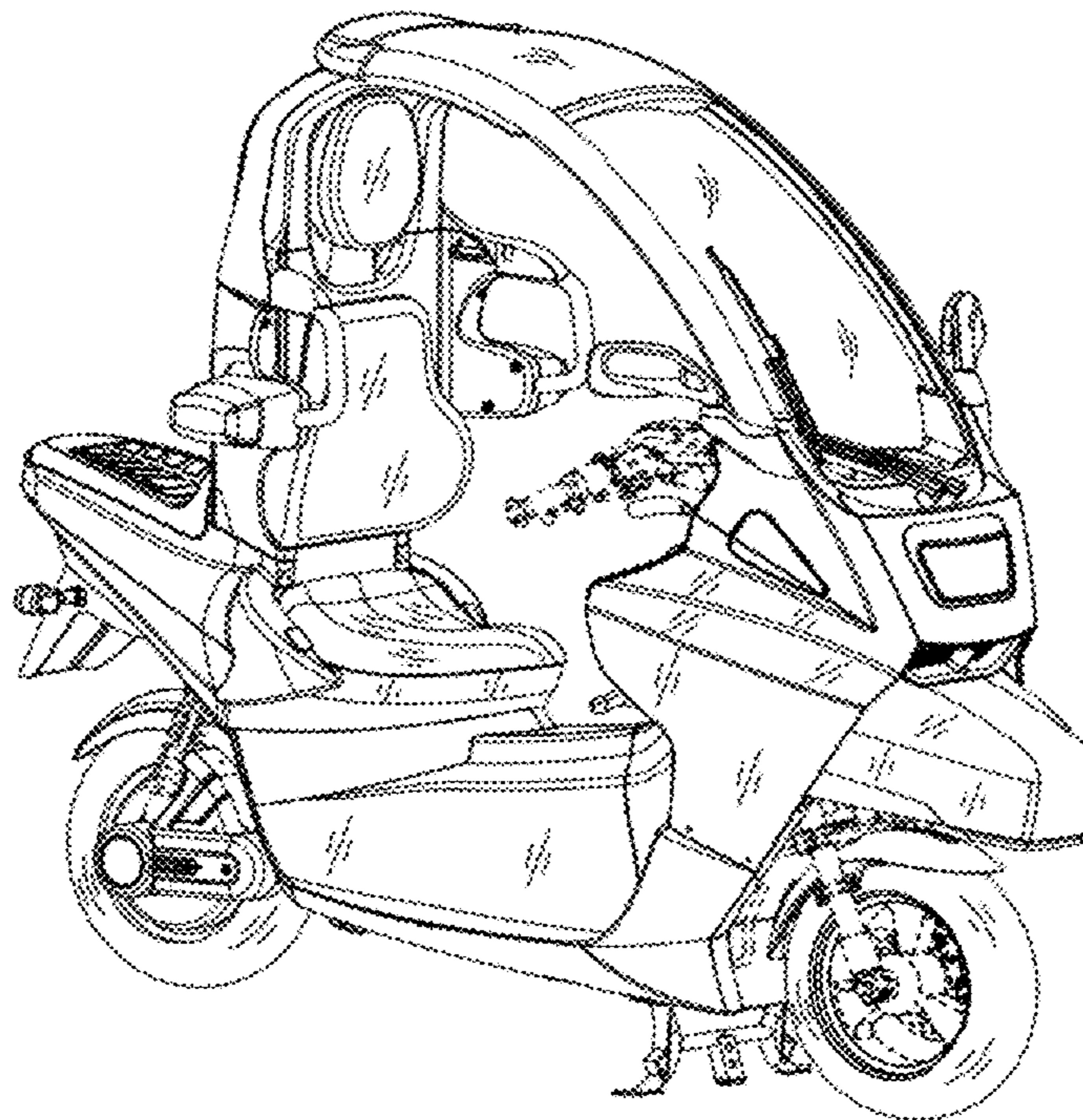

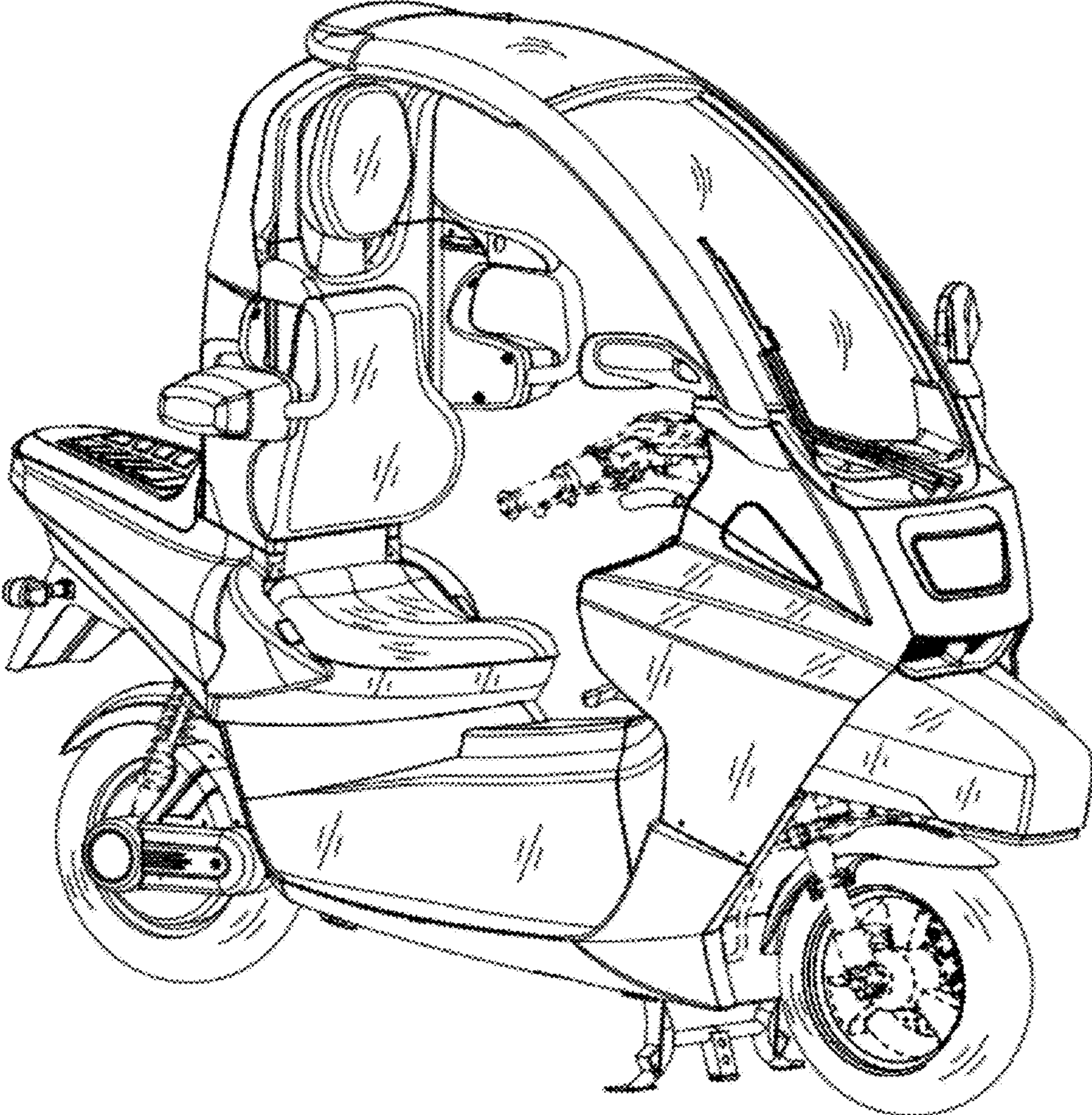

FIG. 1

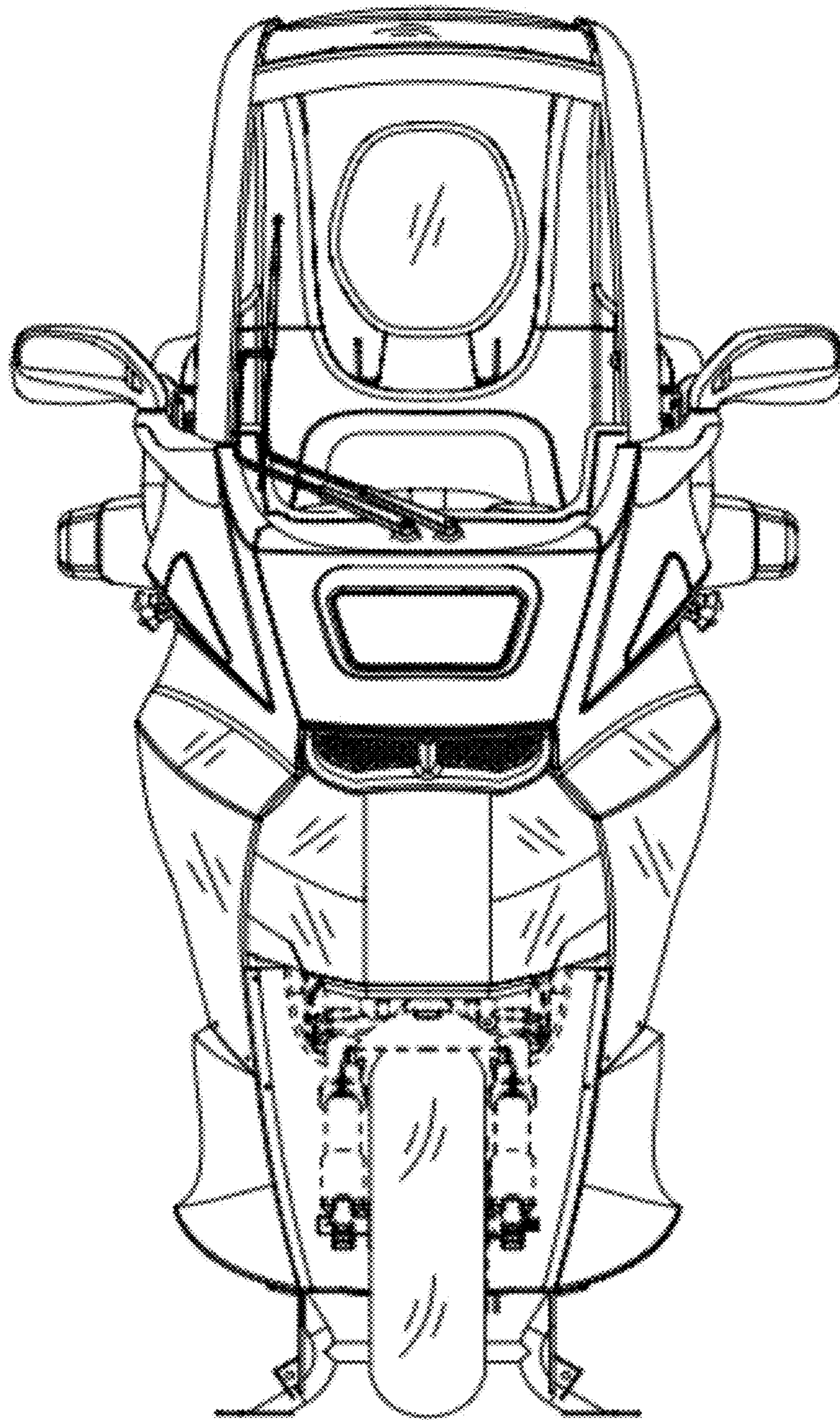

FIG. 2

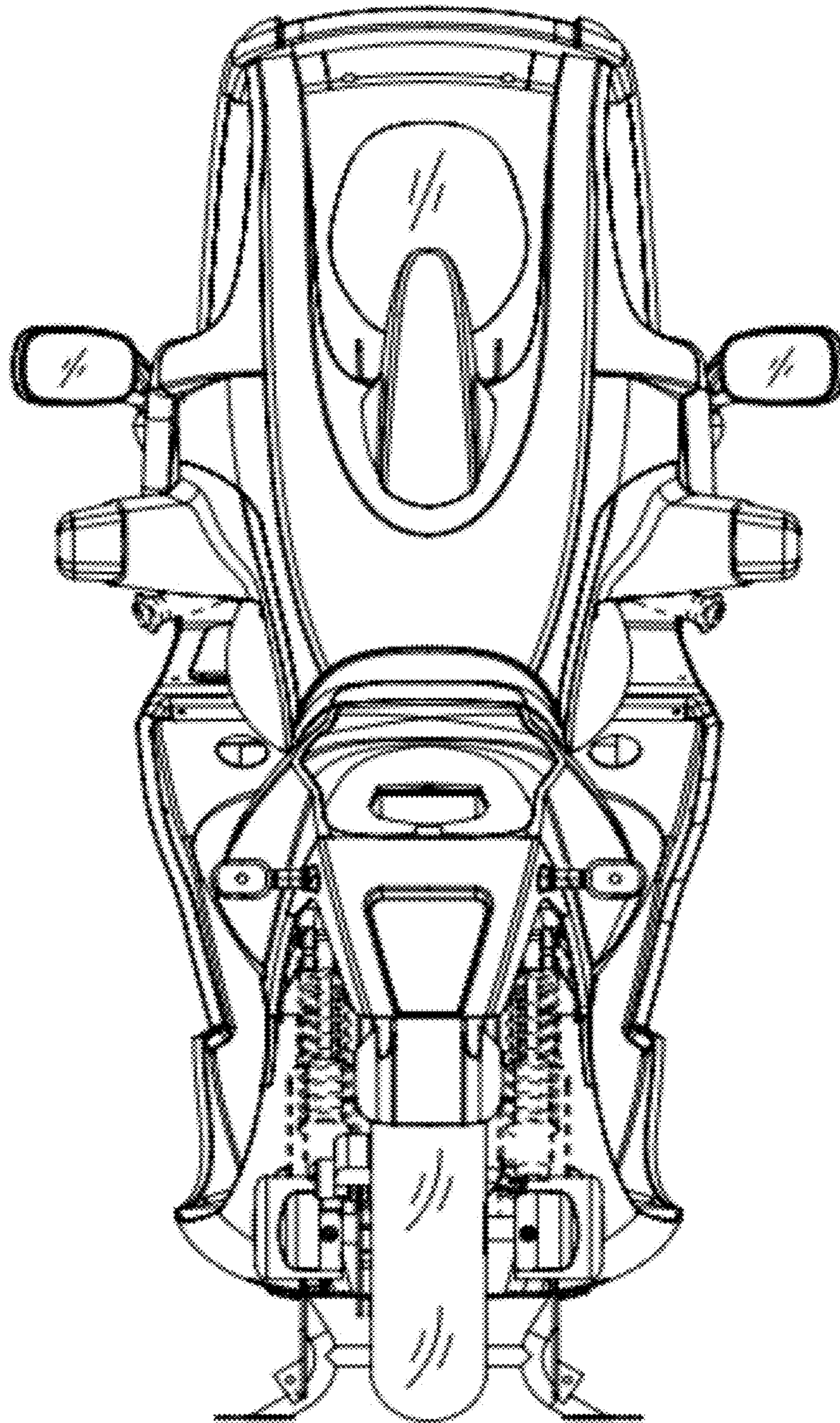

FIG. 3

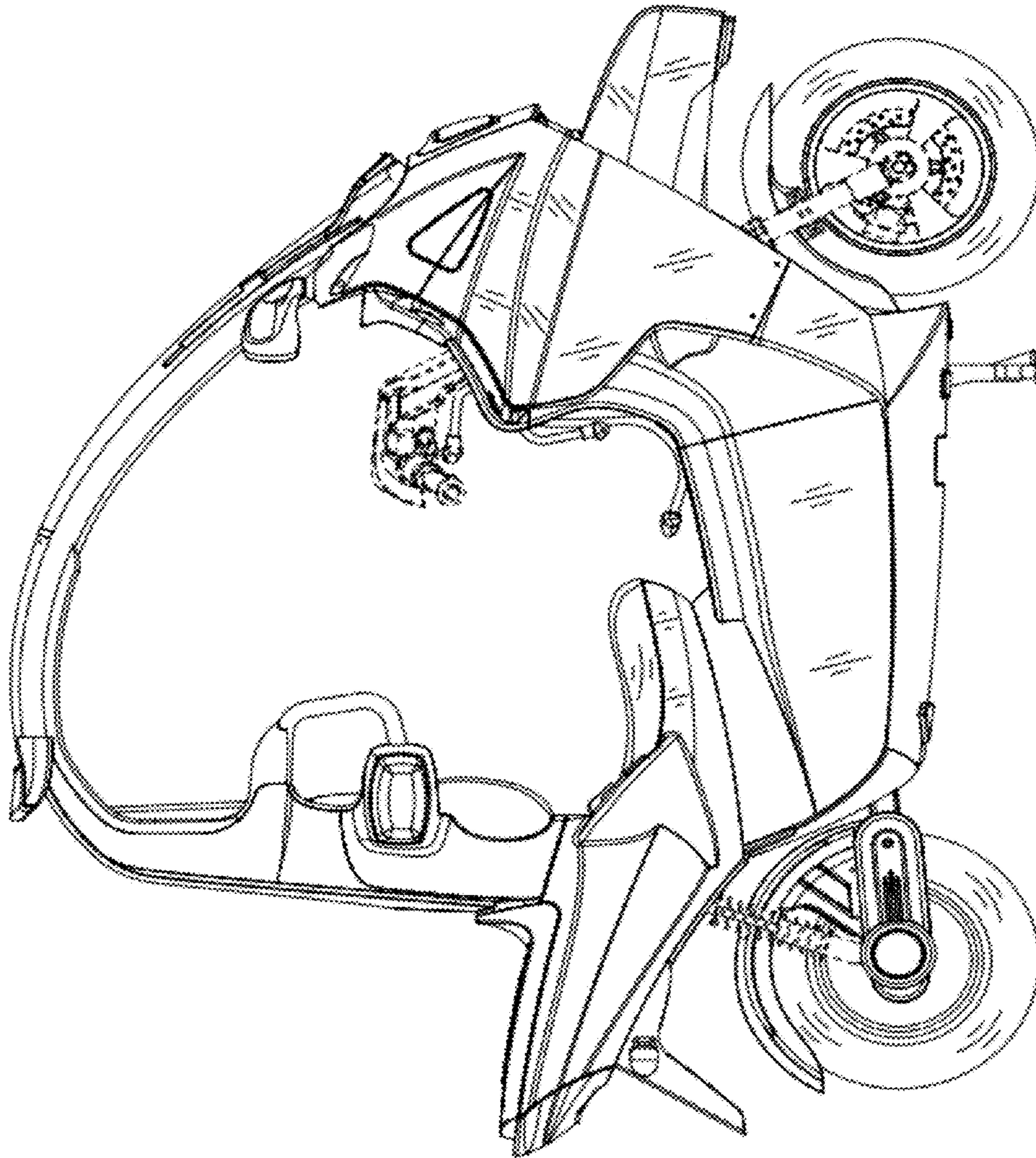

FIG. 4

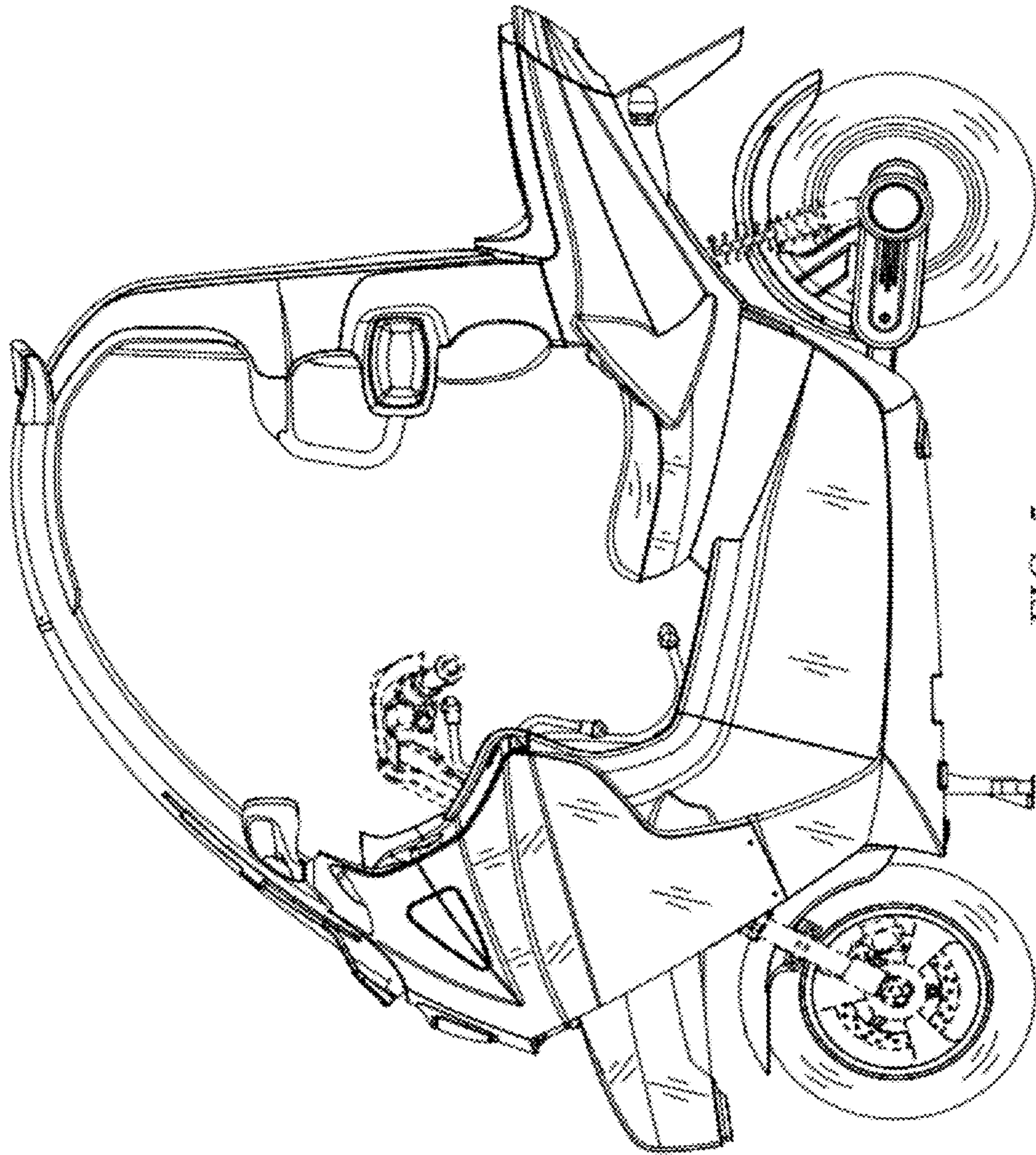

FIG. 5

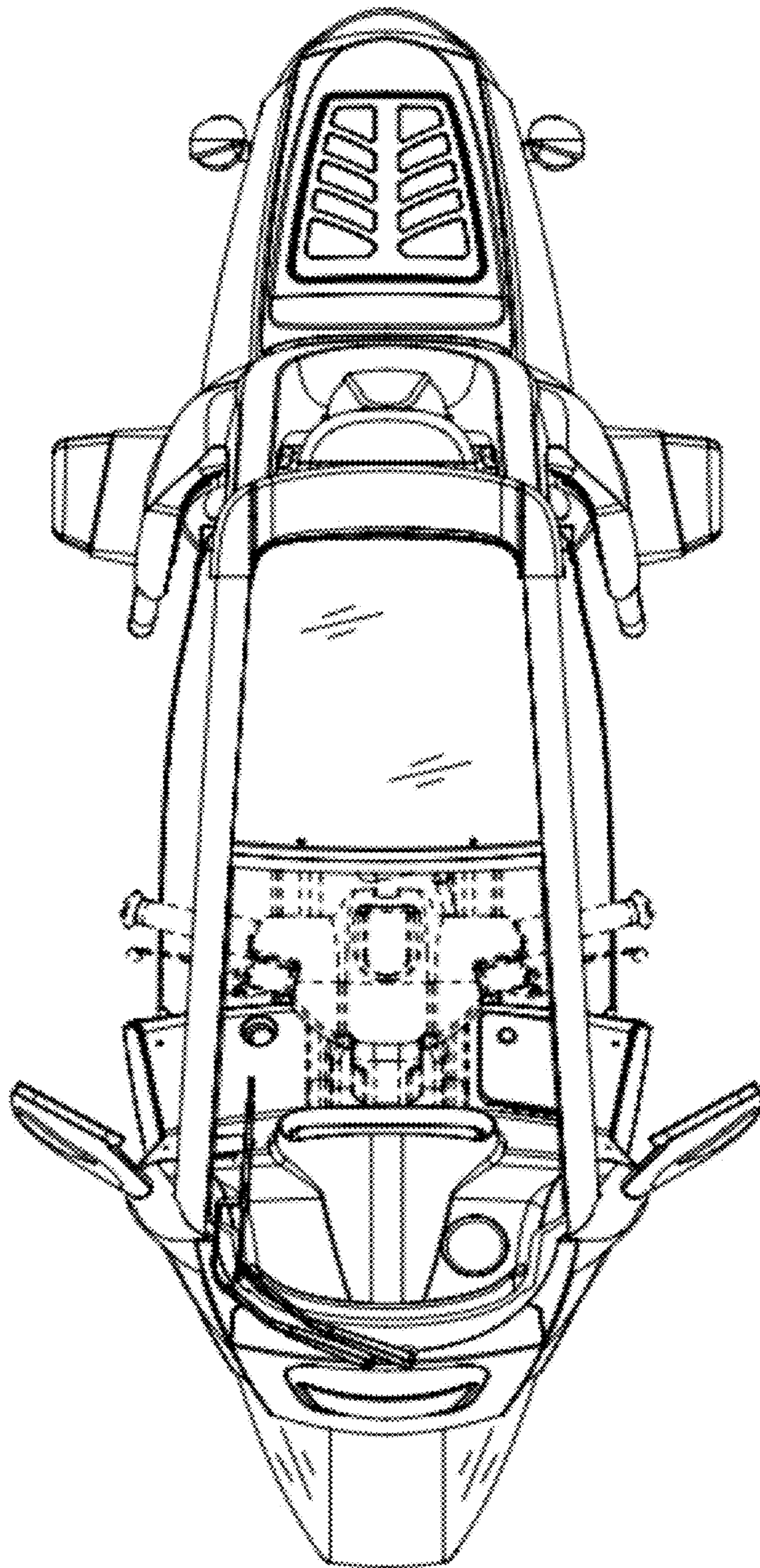

FIG. 6