

US00D663191S

(12) **United States Design Patent**  
**Taatjes et al.**

(10) **Patent No.:** **US D663,191 S**  
(45) **Date of Patent:** **\*\* Jul. 10, 2012**

(54) **FILAMENT SPOOL**  
(75) Inventors: **Thomas L. Taatjes**, Eden Prairie, MN (US); **Patrick W. Turley**, Eden Prairie, MN (US); **Martin G. Zalusky**, Bloomington, MN (US)

(73) Assignee: **Stratasys, Inc.**, Eden Prairie, MN (US)

(\*\*) Term: **14 Years**

(21) Appl. No.: **29/378,539**

(22) Filed: **Nov. 5, 2010**

**Related U.S. Application Data**

(62) Division of application No. 29/363,024, filed on Jun. 3, 2010, now Pat. No. Des. 628,466, which is a division of application No. 29/351,230, filed on Dec. 2, 2009, now Pat. No. Des. 618,086, which is a division of application No. 29/340,131, filed on Jul. 14, 2009, now Pat. No. Des. 606,845, which is a division of application No. 29/326,639, filed on Oct. 22, 2008, now Pat. No. Des. 598,733.

(51) **LOC (9) Cl.** ..... **08-05**

(52) **U.S. Cl.** ..... **D8/358**

(58) **Field of Classification Search** ..... D8/359, D8/358, 356, 308; D14/475, 435; D13/137.4; 33/770, 755; 242/614.1, 605, 405, 405.3, 242/378.4, 378.2, 171, 170, 570, 600, 614; 239/198, 197; 137/355.23-355.28, 355.2, 137/355.19, 15.08; 128/205.22; D10/72  
See application file for complete search history.

(56) **References Cited**

**U.S. PATENT DOCUMENTS**

D71,171 S 10/1926 Bonn ..... D8/358  
D79,201 S 8/1929 Mills ..... D8/358  
1,906,495 A 5/1933 Stine  
3,358,943 A 12/1967 Ernest

D224,683 S 8/1972 Wada et al. .... D14/475  
D228,789 S 10/1973 Koni ..... D14/475  
D230,703 S 3/1974 Nelson ..... D8/358  
D230,991 S 3/1974 Catto ..... D14/475  
D233,411 S 10/1974 Geisler ..... D8/359  
D260,514 S 9/1981 Gell ..... D14/475  
4,387,863 A 6/1983 Edmonston et al. .... 242/118.4  
D276,527 S 11/1984 Flanigan ..... D14/435  
D282,357 S 1/1986 Gell ..... D14/475  
4,657,203 A 4/1987 Crawford ..... 242/125.1

(Continued)

**FOREIGN PATENT DOCUMENTS**

FR 2902681 A1 12/2007

(Continued)

**OTHER PUBLICATIONS**

International Search Report and Written Opinion of International Application No. PCT/US2009/061252 filed Oct. 20, 2009.

*Primary Examiner* — Susan Bennett Hattan

(74) *Attorney, Agent, or Firm* — Brian R. Morrison; Westman, Champlin & Kelly, P.A.

(57) **CLAIM**

The ornamental design for a filament spool, as shown and described.

**DESCRIPTION**

FIG. 1 is a top front perspective view of a fourth embodiment thereof;

FIG. 2 is a top view thereof, the bottom of the fourth embodiment being unclaimed;

FIG. 3 is a front view thereof;

FIG. 4 is a rear view thereof;

FIG. 5 is a left side view thereof; and,

FIG. 6 is a right side view thereof.

The broken lines in the drawings depict environmental subject matter only and form no part of the claimed design.

**1 Claim, 3 Drawing Sheets**

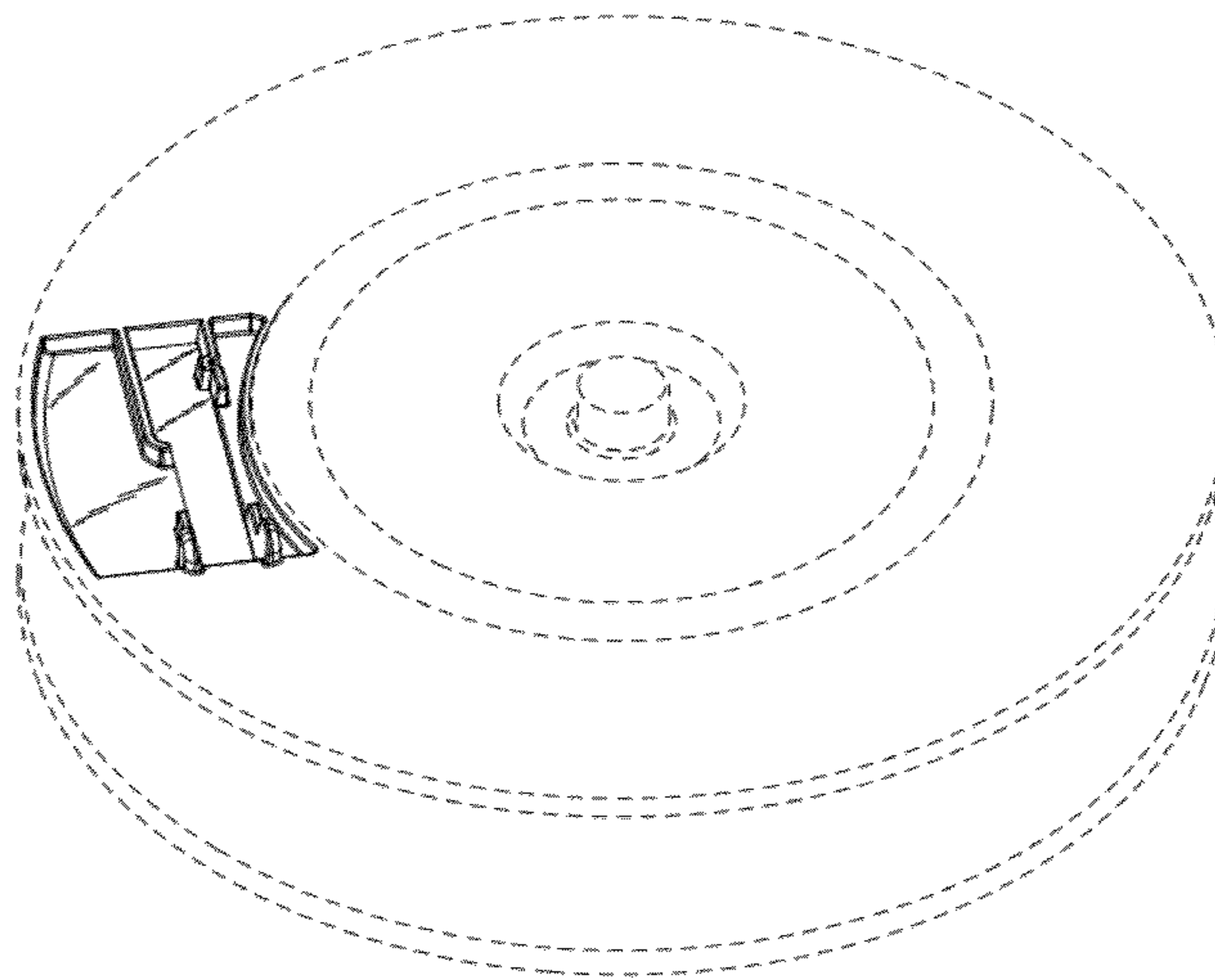

# US D663,191 S

Page 2

## U.S. PATENT DOCUMENTS

5,121,329 A 6/1992 Crump ..... 700/119  
D343,319 S 1/1994 Phillips ..... D6/515  
D346,379 S 4/1994 Patel et al. .... D14/475  
5,340,433 A 8/1994 Crump ..... 156/578  
5,503,785 A 4/1996 Crump et al. .... 264/40.7  
D381,645 S 7/1997 Johnson ..... D14/475  
D406,049 S 2/1999 Bernat ..... D8/358  
D408,720 S 4/1999 Sheng ..... D8/359  
5,939,008 A 8/1999 Comb et al. .... 264/308  
5,968,561 A 10/1999 Batchelder et al. .... 425/375  
6,022,207 A 2/2000 Dahlin et al. .... 425/145  
6,070,107 A 5/2000 Lombardi et al. .... 700/119  
6,085,957 A 7/2000 Zinniel et al. .... 226/8  
D436,021 S 1/2001 Arnold ..... D8/358  
D436,111 S 1/2001 Hahn et al. .... D14/475  
6,228,923 B1 5/2001 Lombardi et al. .... 524/425  
D470,498 S 2/2003 Argumedo et al. .... D14/435  
D474,191 S 5/2003 Nakayama ..... D14/475  
6,685,866 B2 2/2004 Swanson et al. .... 264/308  
6,715,710 B1 4/2004 Russell et al. .... 242/605  
6,722,872 B1 4/2004 Swanson et al. .... 425/225  
D491,048 S 6/2004 Cornier et al. .... D8/358  
6,776,602 B2 8/2004 Swanson et al. .... 425/376.1  
6,790,403 B1 9/2004 Priedeman et al. .... 264/442  
D504,307 S 4/2005 Dayan ..... D8/358

6,991,197 B2 1/2006 Cox et al. .... 242/614.1  
7,063,285 B1 6/2006 Turley et al. .... 242/171  
7,066,425 B2 6/2006 Cornier et al. .... 242/614  
7,169,337 B2 1/2007 Swanson et al. .... 242/563  
D557,118 S 12/2007 Linginfelter ..... D8/358  
7,341,214 B2 3/2008 Taatjes et al. .... 242/170  
7,384,255 B2 6/2008 LaBossiere et al. .... 425/190  
D595,121 S 6/2009 Murphy ..... D8/358  
D598,733 S 8/2009 Taatjes et al. .... D8/358  
D598,922 S 8/2009 Taatjes et al. .... D14/475  
D606,845 S 12/2009 Taatjes et al. .... D8/358  
D618,086 S 6/2010 Taatjes et al. .... D8/358  
D623,927 S \* 9/2010 Gu et al. .... D8/358  
D628,466 S 12/2010 Taatjes et al. .... D8/358  
2004/0129823 A1 7/2004 Swanson et al. .... 242/563  
2006/0076454 A1 4/2006 Kawada ..... 242/600  
2007/0001050 A1 1/2007 Taatjes et al. .... 242/598.6  
2007/0228590 A1 10/2007 LaBossiere et al. .... 264/40.1  
2009/0050732 A1 2/2009 Ishikawa ..... 242/608.8

## FOREIGN PATENT DOCUMENTS

GB 551992 A 3/1943  
GB 2079247 A 1/1982  
GB 2438394 A 11/2007

\* cited by examiner

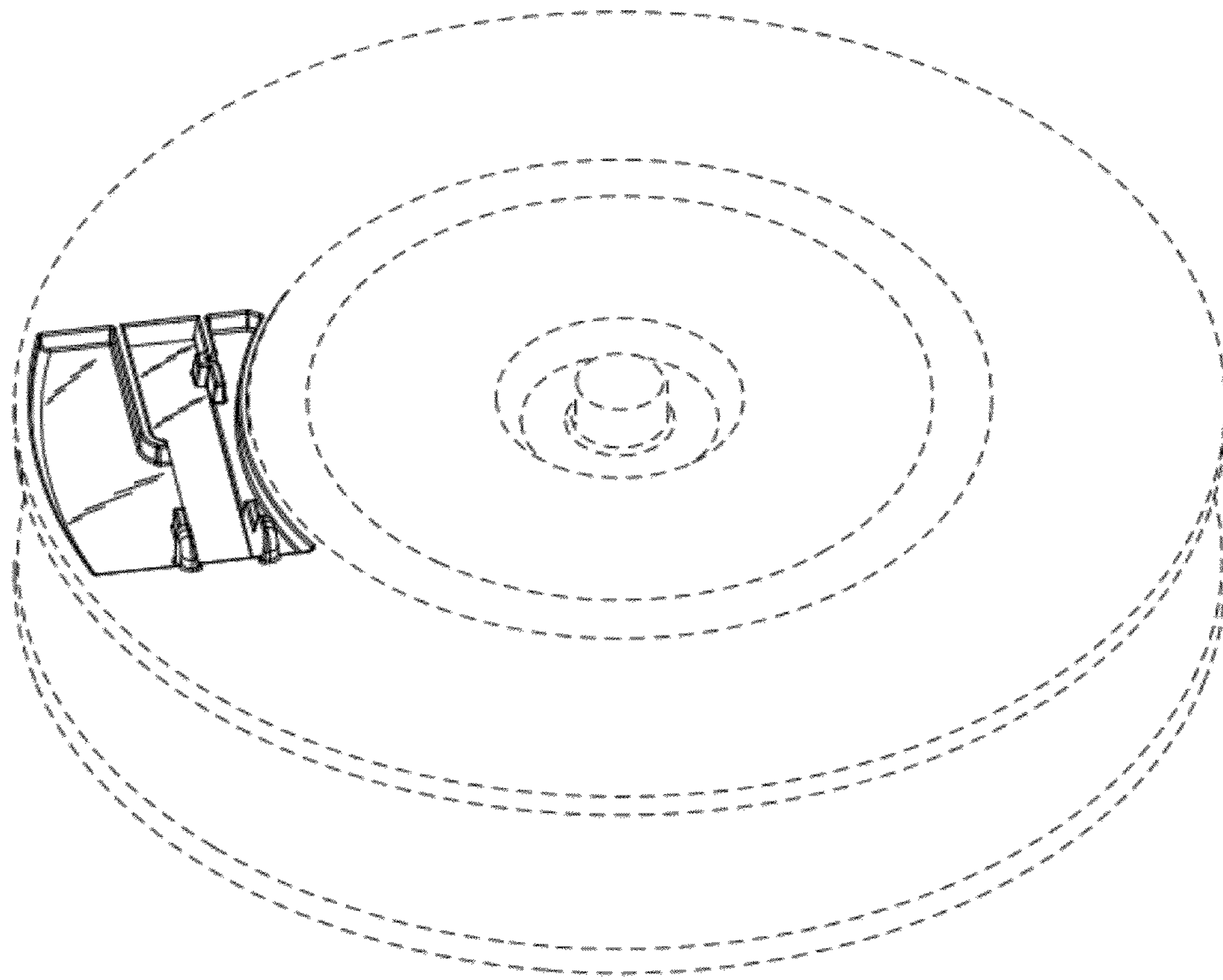

FIG. 1

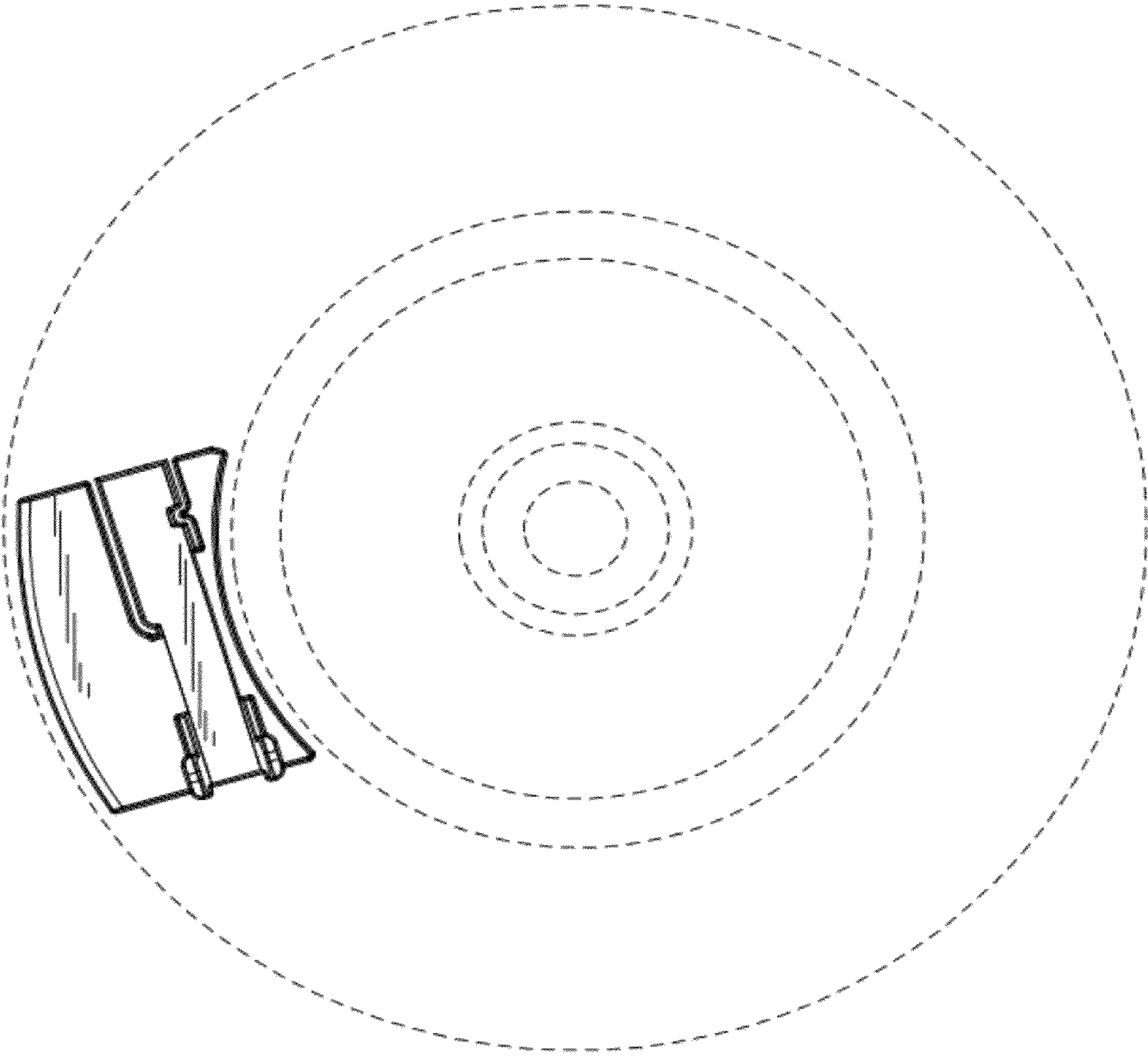

FIG. 2

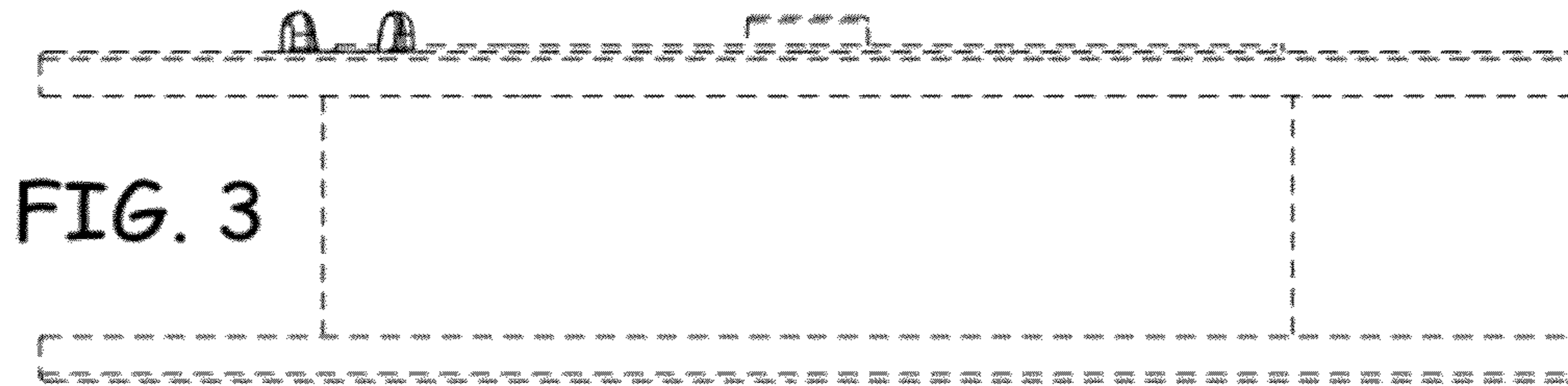

FIG. 3

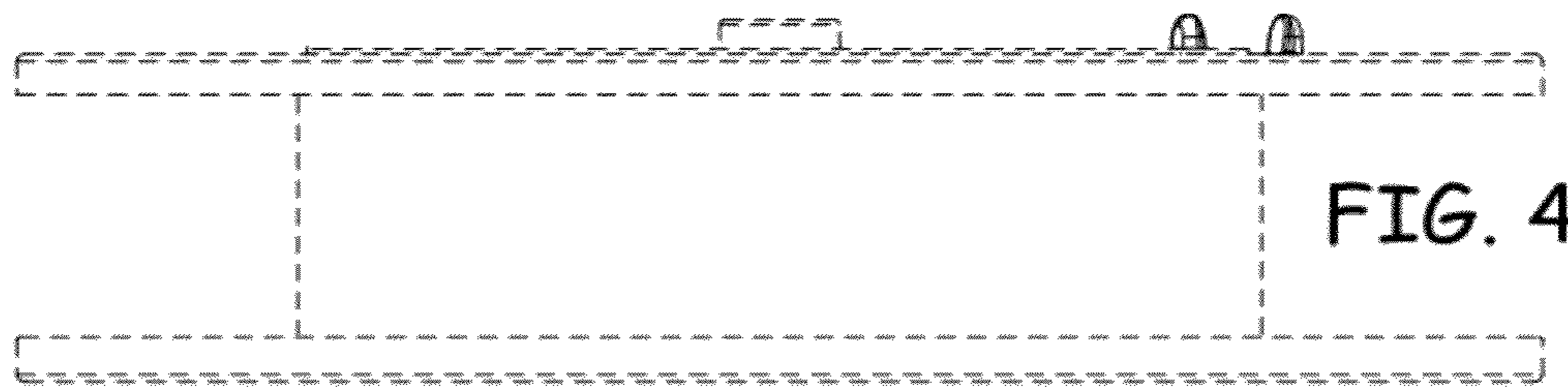

FIG. 4

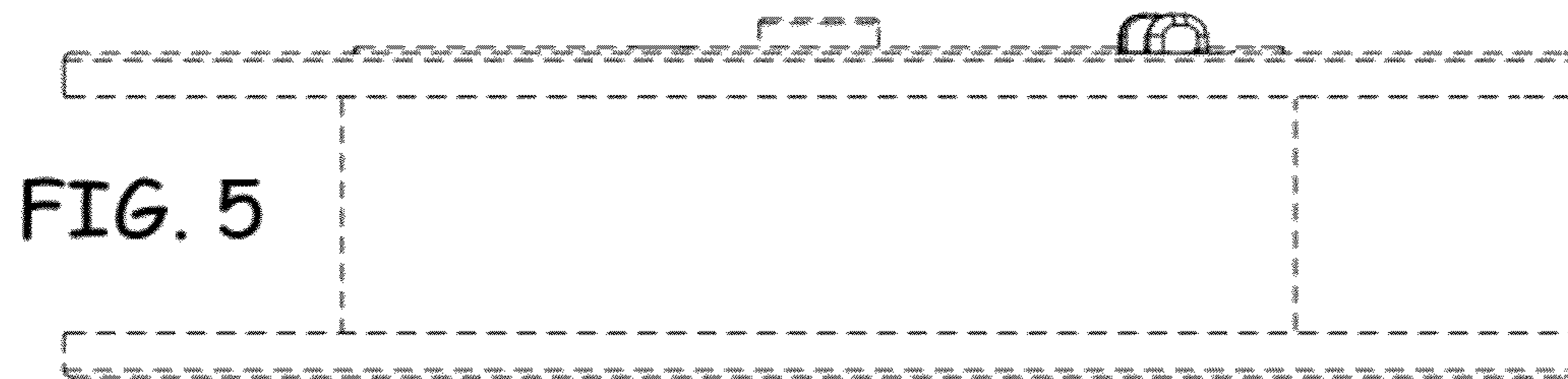

FIG. 5

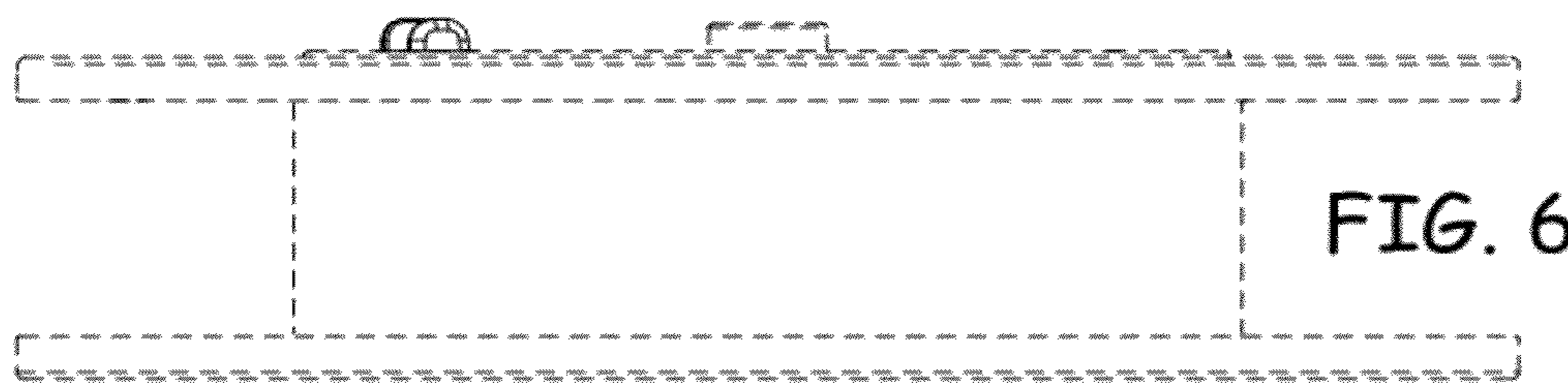

FIG. 6

UNITED STATES PATENT AND TRADEMARK OFFICE  
**CERTIFICATE OF CORRECTION**

PATENT NO. : D663,191 S  
APPLICATION NO. : 29/378539  
DATED : July 10, 2012  
INVENTOR(S) : Thomas L. Taatjes

Page 1 of 1

It is certified that error appears in the above-identified patent and that said Letters Patent is hereby corrected as shown below:

On the Title Page

In the Description:

For FIG. 1, delete "fourth embodiment thereof" and insert --filament spool--

For FIG. 2, delete "fourth embodiment" and insert --filament spool--

Signed and Sealed this  
Twelfth Day of December, 2017



Joseph Matal  
*Performing the Functions and Duties of the  
Under Secretary of Commerce for Intellectual Property and  
Director of the United States Patent and Trademark Office*